

20th September 2005

An electron-multiplying ‘Micromegas’ grid made in silicon wafer post-processing technology

M. Chefdeville^a, P. Colas^b, Y. Giomataris^b, H. van der Graaf^a,
E.H.M Heijne^c, S. van der Putten^a, C. Salm^d, J. Schmitz^d,
S. Smits^d, J. Timmermans^{a,*}, J.L. Visschers^a

^a*NIKHEF, Amsterdam, The Netherlands*

^b*DAPNIA, CEA Saclay, Gif sur Yvette, France*

^c*CERN, Geneva, Switzerland*

^d*University of Twente/MESA+, The Netherlands*

Abstract

A technology for manufacturing an aluminium grid onto a silicon wafer has been developed. The grid is fixed parallel and precisely to the wafer (anode) surface at a distance of 50 μm by means of insulating pillars. When some 400 V are applied between the grid and (anode) wafer, gas multiplication occurs: primary electrons from the drift space above the grid enter the holes and cause electron avalanches in the high-field region between the grid and the anode. Production and operational characteristics of the device are described. With this newly developed technology, CMOS (pixel) readout chips can be covered with a gas multiplication grid. Such a chip forms, together with the grid, an *integrated* device which can be applied as readout in a wide field of gaseous detectors.

Key words: Electron gas multiplication, Micromegas, integrated grid, wafer post-processing, microelectrodes, microsensors, wafer-scale integration, SU-8
PACS: 29.40Gx, 29.40 Cs

Preprint submitted to Nucl. Instr. and Meth. A

* Corresponding author: P.O. Box 41882, 1009 DB Amsterdam, The Netherlands;
Tel. +31205925112; e-mail: timmermans@nikhef.nl

1 Introduction

With the invention of the gas-gain grids Micromegas [1] and GEM [2] the granularity of gas-filled detectors has improved dramatically with respect to wire chambers. This granularity can be maximally employed if each of the grid holes is equipped with a readout channel. This can be realised by using a pixel readout chip as anode, placed close to the grid: such a *GridPix* detector can (in principle) measure three space coordinates of single primary electrons (one of which is obtained from the drift time). A ‘proof-of-principle’ of a two-dimensional readout for minimum ionising particles has been published in [3]. The ultimate precision of this measurement is only limited by diffusion effects of the drifting electrons. The integrated grid (*InGrid*), described in this Letter, results in two essential improvements: a) the grid together with the CMOS pixel chip constitutes an *integrated* device that forms the complete readout system of a gas-filled detector and b) the precision of the grid geometry, made in chip technology is much better in comparison to conventional Micromegas or GEM. This should result in a superior gain homogeneity; also the alignment of the grid holes with anode pixel pads will avoid the Moiré effects observed in [3]. The amount of insulating materials in the avalanche volume can be kept to a minimum, which is beneficial for the HV stability. The performance of a *GridPix* detector will largely depend on the parameters of the applied CMOS pixel chip (pixel pitch, pixel geometry, minimum threshold, time resolution). With the chosen fabrication process, *InGrid* can easily be adapted to the geometry of any pixel readout chip (see also [4]).

2 InGrid processing

The *InGrid* structures are manufactured with recently developed techniques applied in Integrated Circuit and MEMS¹ manufacturing. These techniques combine precision and reproducibility with a good contamination control. For convenience reasons, the *InGrids* were fabricated with planar process steps on a 4” silicon wafer (which acts as a dummy substrate). The process steps, as depicted in Figure 1 , are:

- oxidation of the silicon wafer (create 0.2 μm SiO₂ on top);
- deposition and patterning of anode material: 0.2 μm pure Al;
- deposition and exposure of 50 μm SU-8 photo-resist; NO develop;
- optional: deposition and patterning of sacrificial polymer layer (not shown in the figure);
- deposition and patterning of grid material: 0.8 μm pure Al;

¹ Micro-Electro-Mechanical Systems

- development of SU-8 photo-resist through the grid holes.

The removal of the unexposed SU-8 (development) is postponed to the process end, to be able to deposit the flat grid layer on top of the SU-8 layer [5]. This technique is commonly applied for manufacturing suspended membranes in MEMS (be it normally with SiO₂ and/or Si₃N₄). Throughout the manufacturing process, the temperature remains below 200 °C. This is considered a safe temperature range to allow manufacturing of *InGrid* on top of prefabricated wafers of CMOS readout circuits. The resulting *InGrid* is shown in Figure 2.

3 Experimental set-up

For testing the *InGrid* wafer, a small chamber was built, consisting of an aluminium base plate and a cover. The wafer (thickness 300 μm) was fixed on the base plate by means of nylon screws. A sensitive volume and drift gap was created by placing a cathode foil at a distance of 10 mm. The foil, held in a frame (diameter 100 mm), was fixed parallel to the base plate, by means of insulating spacers. A kapton gas seal was mounted at a distance of 20 mm from the base plate. The cathode foil covered the entire wafer (see Figure 3). By means of feedthroughs, connections can be made from outside the gaseous volume to the cathode, the grid and the anode. A metal shielding box contains preamps and filters, to which HV can be connected and signals and currents can be measured (see Figure 4). The charge signal of the grid is fed into a low-noise charge amplifier [6]. The integration time constant of this amplifier (1 μs) is large compared to the time it takes to complete the grid signal (≈ 50 ns [3]); the preamp output pulse is therefore proportional to the avalanche charge. The calibration constant for the amplifier is measured in-situ by applying test pulses on a (precisely measured) test capacity of 11.5 pF. In series with the HV connections to the grid and cathode, and in the anode grounding line, resistors of 10 M Ω are included. By measuring the voltage over these resistors with a high-impedance digital voltmeter, the currents can be accurately measured. The detector was tested by means of X-ray quanta from a ⁵⁵Fe source. Using a collimator the detector could be irradiated with a 1 mm wide pencil beam.

4 Results

For the first measurements the chamber was flushed with a He/Isobutane 80/20 gas mixture as used in [3]. With the cathode at -1400 V, the grid at -400 V, and the anode on ground potential, charge pulses from the ⁵⁵Fe irradiation

were observed at the output of the charge amplifier. The pulse height spectrum (Figure 5) shows a typical photo peak and a Compton continuum.

When flushing the chamber with an Ar/Isobutane 80/20 mixture the ^{55}Fe spectrum of Figure 5 was obtained. The escape peak and photo peak are well separated and the photo peak is clearly non-symmetric. It shows the excellent energy resolution of this proportional chamber. The asymmetry in the photo peak is due to the superposition of the 5.90 keV and 6.49 keV lines of the ^{55}Fe source, the latter being emitted 9 times less than the first. Analysing the photo peak, an energy resolution of 6.5% RMS was found, close to the ultimate resolution expected [7,8].

The gas gain was measured as a function of the grid potential; the cathode was always held at $V_{\text{grid}} - 1000$ V. For this measurement it was assumed that ^{55}Fe quanta contributing to the photo peak, generate 220 primary electrons on average [9]. The results are shown in Figure 6. Gas gains up to 7000 at -440 V between grid and anode are obtained. The exponential relation shows that the gain doubles when the grid potential is raised by 20.7 V, in agreement with earlier results from Micromegas chambers [10].

The homogeneity of the gas gain of the detector was measured by scanning the circularly shaped fiducial surface (diameter 15 mm) of the *InGrid* detector with the collimated ^{55}Fe source. The measured gains were found to be within $\pm 5.5\%$ from the average, corresponding to the resolution of the measurements.

The detector currents were measured from the voltage drop over the resistors in series with the anode, the grid and the cathode. The results, with the ^{55}Fe source at a fixed position on the chamber, are shown as a function of the grid voltage in Figure 7. Without source, the anode current was smaller than 0.01 nA.

In future applications an Ar/ CO_2 mixture may be required in order to limit chamber ageing. The gain curve with this gas mixture is also shown in Figure 6. The gas gain that can be reached with such a mixture, should be high enough to detect single-electron initiated avalanches with sufficient efficiency [3] and to enable to perform an ageing test in a reasonable amount of time.

5 Conclusions and future plans

By means of wafer post-processing, in which typical technologies for chip manufacturing are used, a grid can be manufactured, fixed on insulating pillars, and held at a fixed distance from an anode plane, thus forming an electron-multiplying gaseous detector. The precision and uniformity of the new device

results in an unprecedented, but expected performance in terms of energy resolution and stability.

In next versions of experimental *InGrids*, the grid hole size and shape (round, square, hexagonal), the hole pitch and hole pattern (square or hexagonal) and the gap size (between 10 and 50 μm) will be varied and their performance measured. Also the possibility to divide the grid in small low-capacitance sections will be investigated. These sections will be individually connected via a resistor to a common HV source, in order to limit discharges to an acceptable maximum. By means of an intense X-ray source, ageing tests will be performed.

We plan to apply this technology on Medipix2 chips [11,3], as well as on the PSI46 chips [12]. With the latter, the device could be used as a fast vertex detector in high radiation environments [13].

As an alternative for the present single grid ‘Micromegas’ structure, we will also investigate the feasibility of a double grid array. In such a structure, which could either be a GEM-like structure or a double Micromegas, gas multiplication will occur in the high electric field region between the grids. This has the advantage of operating the device with a much lower electric field directly above the anode, limiting the risk of discharges that could damage the anode pixel readout chips.

Acknowledgements

We would like to thank Tom Aarnink, Dominique Altpeter, Wim Gotink and Joop Rövekamp for their creative and essential contributions to the realisation of the test detectors.

References

- [1] Y. Giomataris *et al.*, *Micromegas: a high-granularity position-sensitive gaseous detector for high particle-flux environments*, Nucl. Instr. and Methods A 376 (1996) 29.
- [2] F. Sauli *et al.*, *The gas electron multiplier (GEM)*, Nucl. Instr. and Methods A 386 (1997) 531.
- [3] M. Campbell *et al.*, *Detection of single electrons by means of a Micromegas-covered MediPix2 pixel CMOS readout circuit*, Nucl. Instr. and Methods A 540 (2005) 295.

- [4] M.J. Key *et al.*, *Fabrication of gas amplification microstructures with SU8 photosensitive epoxy*, Nucl. Instr. and Methods A 525 (2004) 49;
M.J. Key, V. Cindro and M. Lozano, *On the radiation tolerance of SU-8, a new material for gaseous microstructure radiation detector fabrication*, Radiation Physics and Chemistry 71 (2004) 1003.
- [5] Ch. Chung and M. Allen, *Uncrosslinked SU-8 as sacrificial material*, J. Micromech. Microeng. 15 (2005) N1.
- [6] F. Bakker and P. Rewiersma, *Honeycomb Strip Amplifier*, NIKHEF report ETR 94-01, 1994.
- [7] A. Delbart *et al.*, *New developments of Micromegas detector*, Nucl. Instr. and Methods A 461 (2001) 84.
- [8] W. Riegler, C. Lippmann and R. Veenhof, *Detector physics and simulation of resistive plate chambers*, Nucl. Instr. and Methods A 500 (2003) 144.
- [9] F. Sauli, *Principles of operation of multiwire proportional and drift chambers*, CERN Yellow Report 77-09, 1977.
- [10] P. Colas *et al.*, *First test of a Micromegas TPC in a magnetic field*, Nucl. Instr. and Methods A 535 (2004) 181.
- [11] X. Llopart *et al.*, *MediPix2, a 64k pixel read-out with 55 μm square elements working in single photon counting mode*, IEEE Trans. Nucl. Sci. 49 (2002) 2279.
X. Llopart and M. Campbell, *First test measurements of a 64k pixel readout chip working in single photon counting mode*, Nucl. Instr. and Methods A 509 (2003) 157.
- [12] W. Erdmann, *The 0.25 μm front end for the CMS pixel detector*, Proceedings of Vertex 2003, Nucl. Instr. and Methods A 549 (2005) 153.
- [13] M. Campbell *et al.*, *GOSSIP: a vertex detector combining a thin gas layer as signal generator with a CMOS readout pixel array*, Proceedings of Vertex 2004, to appear in Nucl. Instr. and Methods A.

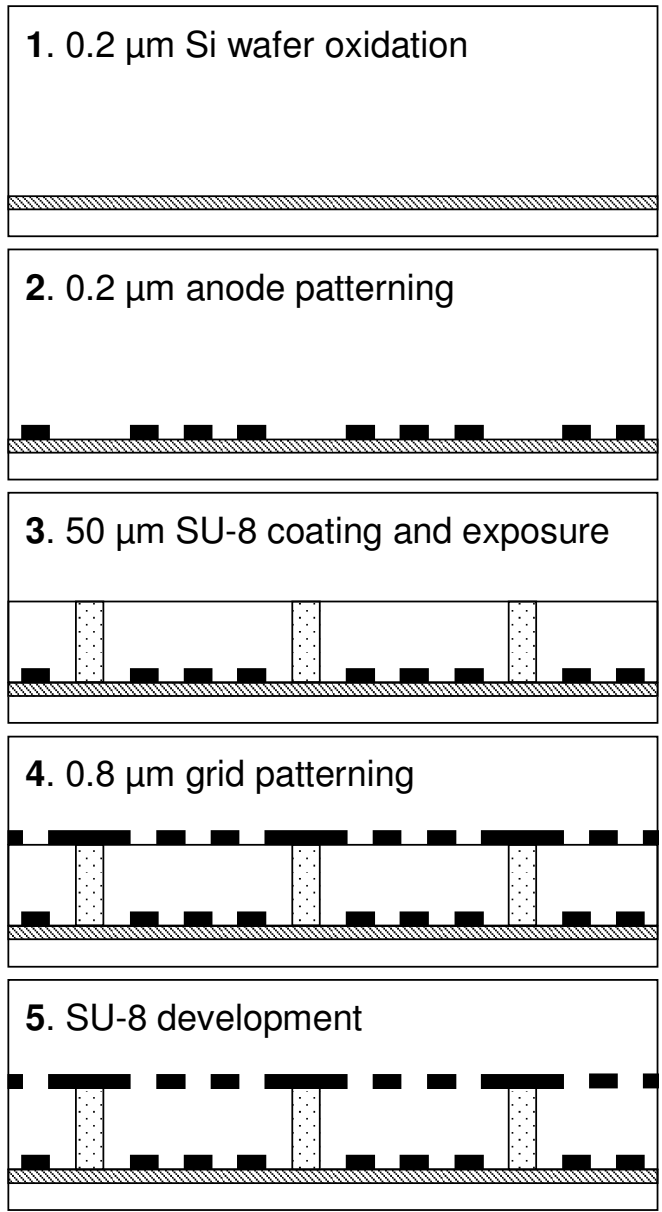

Fig. 1. Flow chart of the various processing steps for *InGrid*. See text for the description of the manufacturing process.

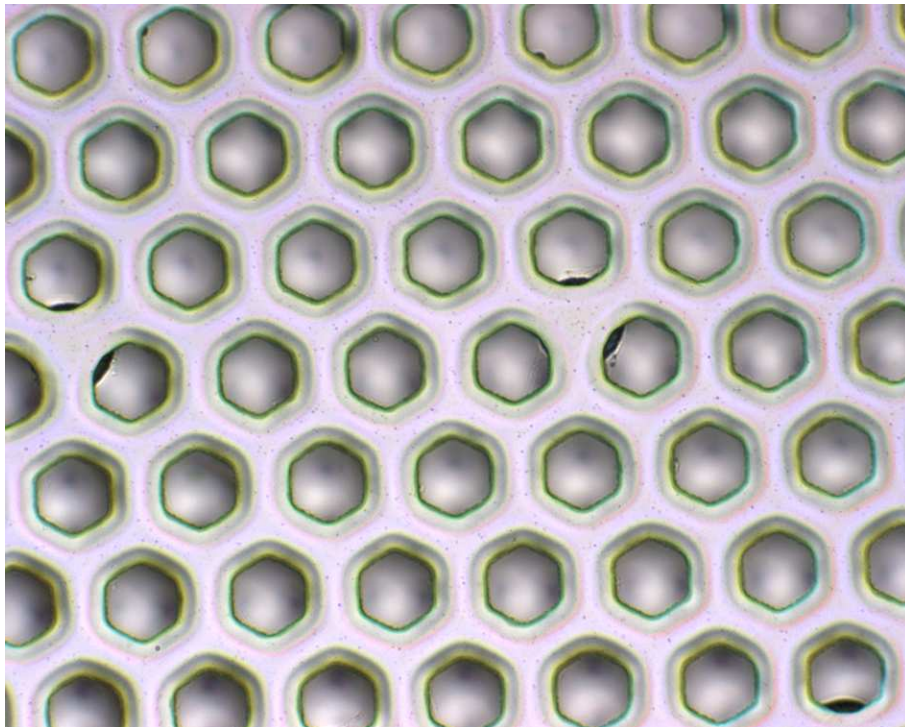

Fig. 2. Top: picture of the *InGrid* wafer. There are 19 fields each with a different grid geometry. Note the individual anode and grid connections at the edge of the wafer. Bottom: The *InGrid* pattern which was used for the measurements. Note the slightly hexagonal holes (hole pitch $60\ \mu\text{m}$). The insulating pillars (diameter $30\ \mu\text{m}$) are centred between three adjacent holes, and are just visible. No local loss of sensitivity is expected.

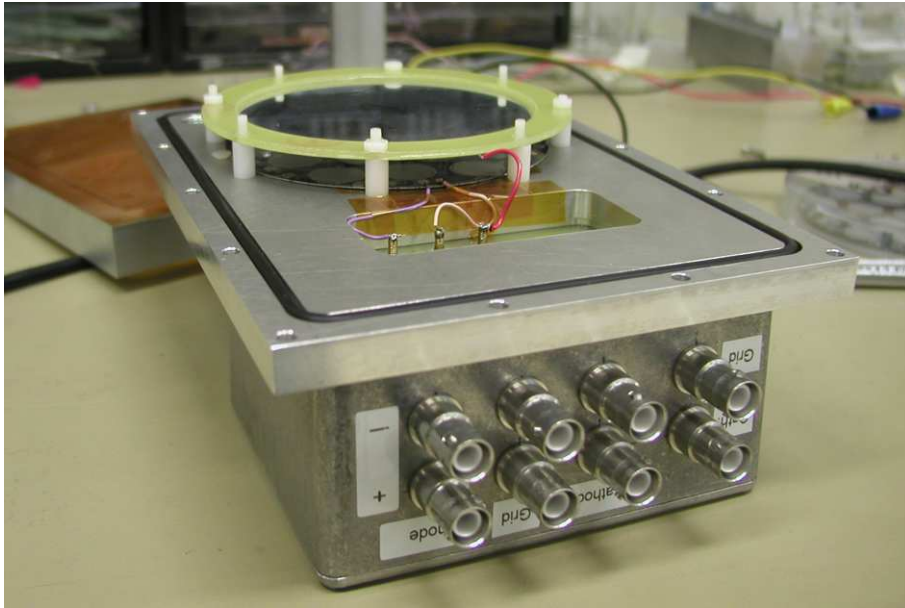

Fig. 3. The test chamber with its gas cover removed together with the HV and signals connection box

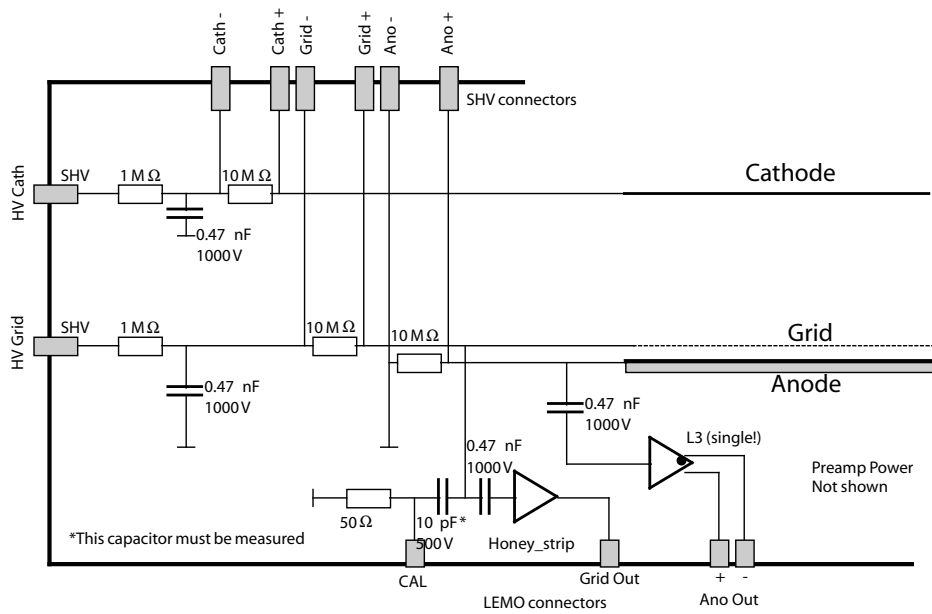

Fig. 4. The HV connections and readout circuitry of the test chamber

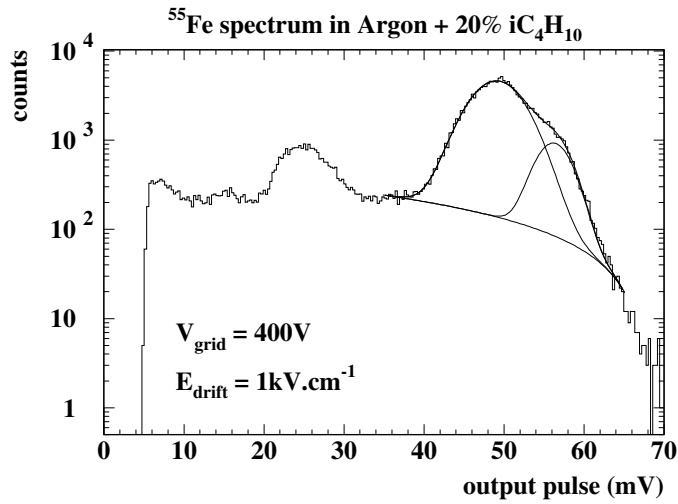
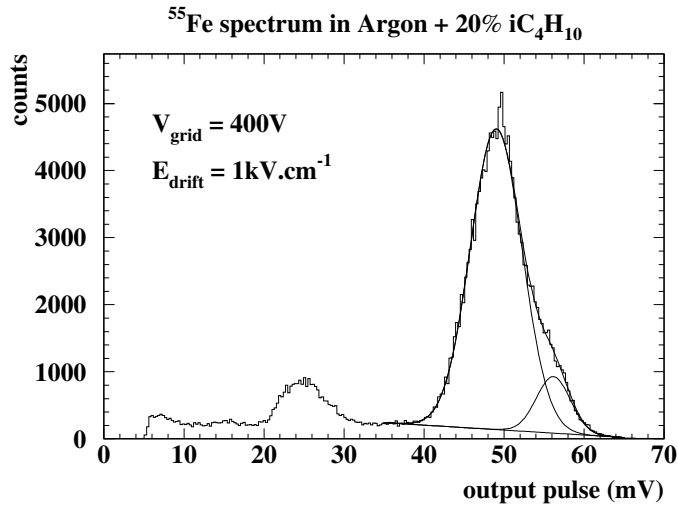
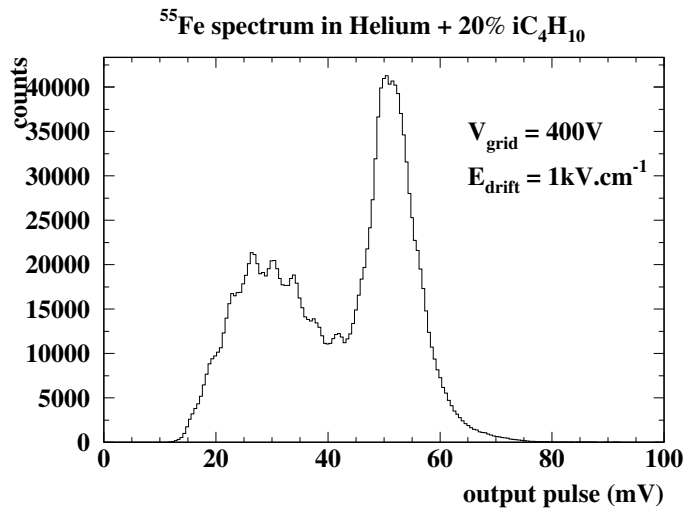

Fig. 5. Measured pulse height from ⁵⁵Fe source for a He/Isobutane 80/20 mixture (top) and for an Ar/Isobutane 80/20 mixture (middle/bottom in linear and logarithmic scale); the curves show the results of the fit to the pulse shape, showing the 5.9 and 6.5 keV lines and their superposition on a linear ‘background’.

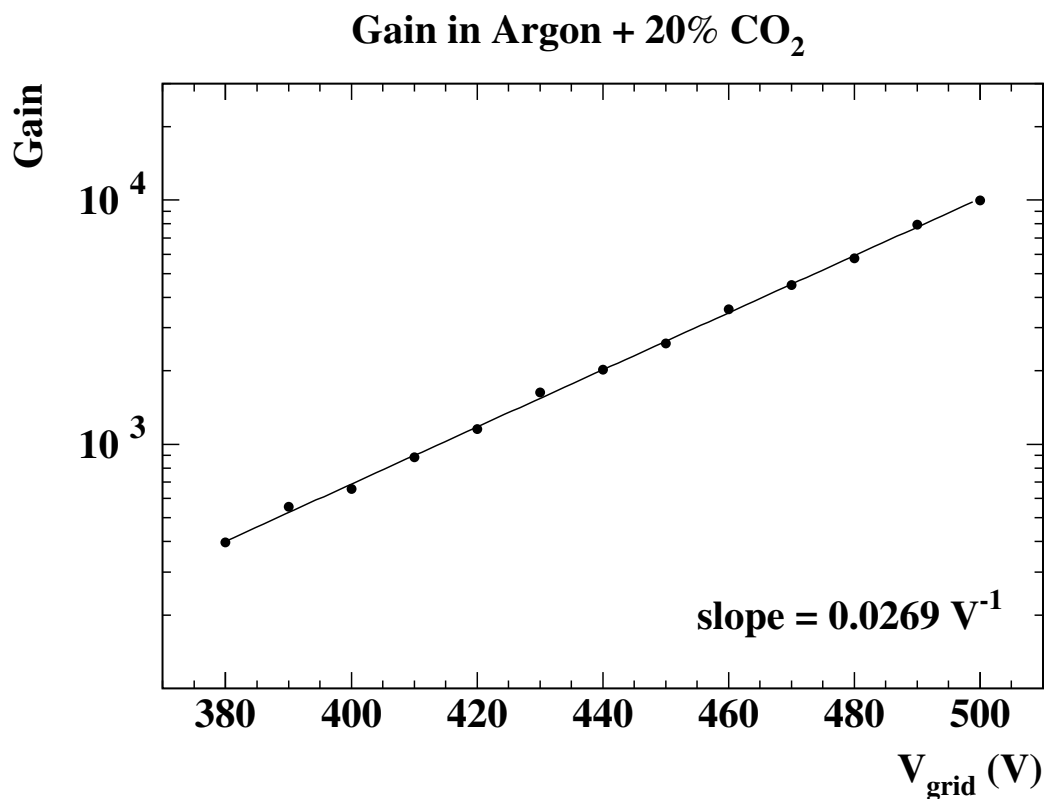
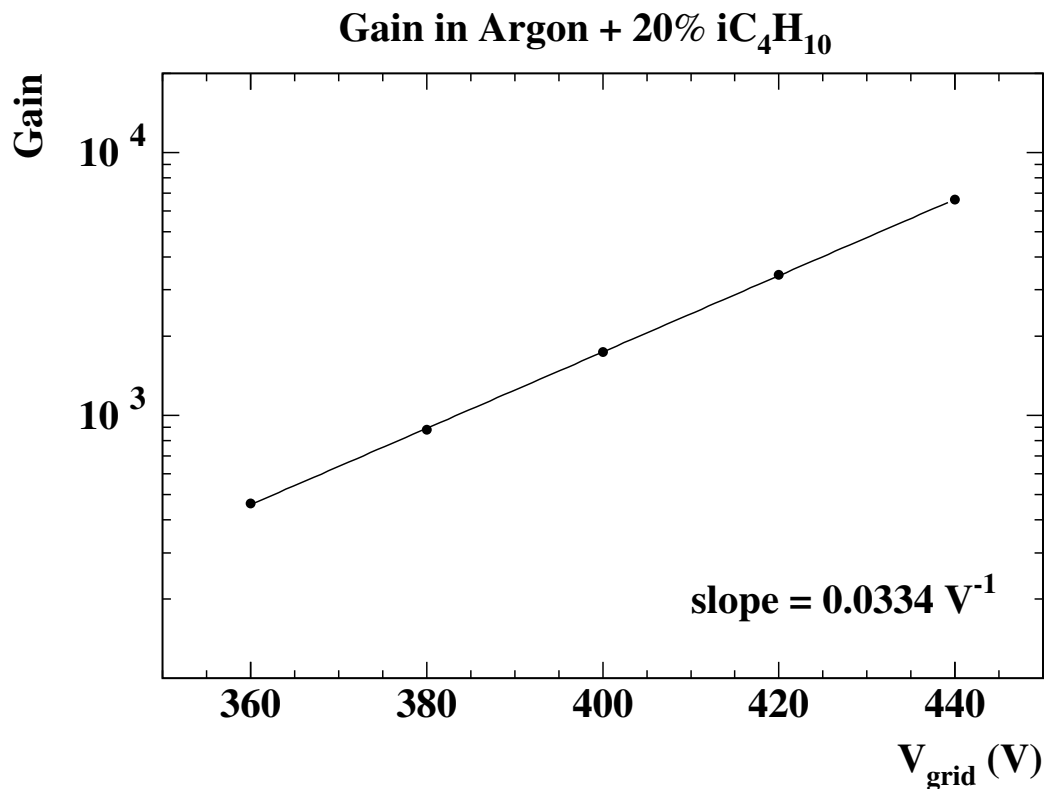

Fig. 6. Measured gas gain vs. grid voltage for Ar/Isobutane 80/20 (top) and for Ar/ CO_2 80/20 (bottom)

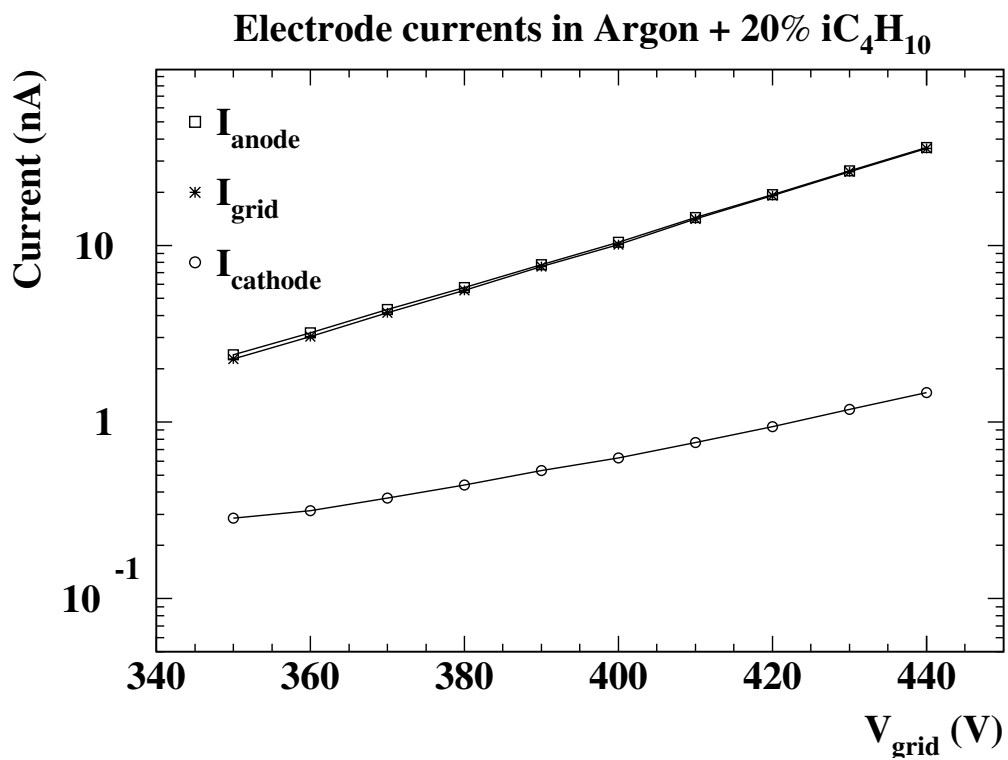

Fig. 7. Measured anode, grid and cathode currents vs. the grid voltage for the Ar/Isobutane 80/20 mixture.