

Coherent π^0 electroproduction on the deuteron.

Michail P. Rekalo *

Middle East Technical University, Physics Department, Ankara 06531, Turkey

Egle Tomasi-Gustafsson

DAPNIA/SPhN, CEA/Saclay, 91191 Gif-sur-Yvette Cedex, France

Jacques Arvieux

Institut de Physique Nucléaire, CNRS/IN2P3, 91406 Orsay Cedex, France

Abstract

A general analysis of polarization phenomena for coherent pion electroproduction on deuterons is presented. The spin and isospin structures of the $\gamma^* + d \rightarrow d + P^0$ amplitudes (where γ^* is a virtual photon) are established and relationships between meson electroproduction on deuterons and on nucleons are given in the framework of the impulse approximation. The reaction $e + d \rightarrow e + d + \pi^0$ is investigated in detail, for a relatively large value of momentum transfer, $0.5 \text{ GeV}^2 \leq -k^2 \leq 2 \text{ GeV}^2$, both at threshold and in the region of Δ -isobar excitation. Special attention is devoted to the sensitivity of different contributions to the exclusive cross section for $d(e, e\pi^0)d$, as the $\gamma^*\pi\omega$ form factor or the NN -potential. The predicted k^2 -dependence of the cross section agrees well with the available experimental data.

39 pages, 18 figures, 1 table

*Permanent address: *National Science Center KFTI, 310108 Kharkov, Ukraine*

Proposed running head:

Coherent π^0 electroproduction on the deuteron.

Corresponding author:

Egle Tomasi-Gustafsson

DAPNIA/SPhN

C.E.A./Saclay

91191 Gif-sur-Yvette Cedex, France

Tel. (33) 1 69 08 39 98

Fax. (33) 1 69 08 75 84

e-mail: etomasi@cea.fr

I. INTRODUCTION

The reaction $\gamma + d \rightarrow d + P^0$, where P^0 is a neutral pseudoscalar meson (π^0 or η), is the simplest coherent meson production process in γd -collisions. The presence of a deuteron with zero isospin in the initial and final states leads to a specific isotopic structure for the corresponding amplitudes. Moreover, although the spin structure may be, in general, fairly complex, it is essentially simplified in the near threshold region making the $\gamma + N \rightarrow N + P^0$ (where N denotes a nucleon) and $\gamma + d \rightarrow d + P^0$ reactions especially interesting for hadron electrodynamics studies.

Pion-electroproduction $e + d \rightarrow e + d + \pi^0$ is even richer since it involves longitudinal as well as transverse photons. Experimental information about this process has been missing for a long time, but such an experiment has recently been performed at MAMI [1] or at Jefferson Lab. In the last case, with the experimental set-up which has been used to measure the tensor deuteron polarization in elastic ed -scattering [2], a sample of π^0 -electroproduction data were obtained during dedicated runs, [3] at relatively large momentum transfer square ($\simeq 1.1 \div 1.6 \text{ GeV}^2$) in the threshold and in the Δ -region.

The $e + d \rightarrow e + d + \pi^0$ reaction allows to "scan" the isospin structure in the full resonance region and to separate isovector from isoscalar contributions. Moreover, experiments using a polarized deuteron target yield a different information compared to measurements of the polarization of the final deuteron.

Another interesting problem of near threshold meson photoproduction on deuterons concerns the isotopic structure of the $\gamma + N \rightarrow S_{11}(1535)$ transition. The results of different multipole analyses of the $\gamma + N \rightarrow N + \pi$ reactions have shown that the $\gamma + N \rightarrow S_{11}(1535)$ transition is essentially isovector [4–7], in agreement with predictions of quark models [8–12]. Experimental data on $\gamma + p \rightarrow p + \eta$ in the near threshold region [13] indicate that the $S_{11}(1535)$ excitation is the main mechanism. On the other hand, the amplitude for $\gamma + d \rightarrow d + \eta$ in the near threshold region has to be isoscalar and, therefore, small in contradiction with earlier data [14] which showed a large cross section. Recent $d(\gamma, \eta) X$ data [15] have given

an explanation by showing that this reaction is essentially inelastic.

We derive here a general analysis for pseudoscalar meson electroproduction on deuterons, based on general symmetry properties of the hadron electromagnetic interaction. A similar analysis limited to pion photoproduction on deuterons has been firstly published in [16–18], where the analysis of different polarization observables has been done searching a sensitivity to possible dibaryon contributions. A study of polarization phenomena in this reaction was continued later in refs. [19,20]. Chiral perturbation theory can not be applied to large momentum transfers, therefore only the s-wave cross section for the process $e + d \rightarrow e + d + \pi^0$ has been calculated at very small momentum transfer, up to $-k^2=0.1 \text{ GeV}^2$ [21]. Recently the process $e + d \rightarrow e + d + \pi^0$ has been object of theoretical investigations [22,23].

An adequate dynamical approach to pion electroproduction has to take into account all previous theoretical findings related to other electromagnetic processes on deuteron, such as elastic ed scattering [24], π^0 -photoproduction, $\gamma + d \rightarrow d + \pi^0$ [25], and deuteron photodisintegration $\gamma + d \rightarrow n + p$ [26]. Similarly to these processes, the reaction $e + d \rightarrow e + d + \pi^0$ will face two main problems: the study of the deuteron structure and of the reaction mechanism, on one side, and the determination of the neutron elementary amplitude on another side.

Elastic ed -scattering, being the simplest process to access the deuteron structure, has been considered, for large momentum transfers, a good case to test different predictions of perturbative QCD, such as the scaling behavior of the deuteron electromagnetic form factors [27] and the hypothesis of helicity conservation [28]. The analysis of the scaling behavior should help in defining the kinematical region of the transition regime from the meson-nucleon degrees of freedom to the quark-gluon description of the deuteron structure. In this respect coherent π^0 -electroproduction of the deuteron opens new possibilities to study the scaling phenomena in different regions due to the more flexible kinematical conditions: it unifies the kinematics of elastic ed -scattering, with its single dynamical variable (the momentum transfer square, k^2) and the process of π^0 -photoproduction, with two independent dynamical variables (the total energy s and the momentum transfer t from the initial to the

final deuteron). As a result, three kinematical variables drive the process $e + d \rightarrow e + d + \pi^0$. Different mechanisms have a leading role in different kinematical regions.

In order to interpret the first experimental data for $e + d \rightarrow e + d + \pi^0$, with small excitation energy of the produced $d\pi^0$ -system (up to the Δ -resonance region) but at relatively large momentum transfer, k^2 , the starting point of the theoretical analysis is naturally the impulse approximation (*IA*). Similarly to previous calculations of elastic ed - scattering and π^0 -photoproduction processes, as a further step, contributions of meson exchange currents (MEC) [29] have to be evaluated in the resonance region, while rescattering effects [30–32] have to be taken into account in the near threshold region. Large disagreements exist, up to now, in a quantitative evaluation of these effects.

The present paper is organized as follows:

a) we first establish the spin structure of the matrix element for the $\gamma^* + d \rightarrow d + P^0$ reaction and give a formalism for the description of polarization observables. The dependence of the $\vec{d}(e, e'P^0)d$ differential cross section on the polarization characteristics of the deuteron target is derived in a general form, using a formalism of structure functions (SF), which is particularly adequate to describe, in the one-photon approximation, the polarization properties for any $e + A \rightarrow e + h + A'$ process (where A is any nucleus and h is a single hadron or hadronic system). These structure functions are further expressed in terms of the scalar amplitudes which parametrize the spin structure of the corresponding electromagnetic current for the process $\gamma^* + d \rightarrow d + P^0$.

b) using the *IA*, we give relations between the scalar amplitudes, describing the $\gamma^* + d \rightarrow d + P^0$ and the $\gamma^* + N \rightarrow N + P^0$ reactions,

c) finally, we calculate some observables for $e + d \rightarrow e + d + \pi^0$ in the framework of the *IA* in order to study its sensitivity to the isotopic structure of the $\gamma^* + N \rightarrow N + \pi^0$ processes near threshold and in the region of Δ excitation, at relatively large $-k^2$. The numerical calculations are done for values of momentum transfer in the range $0.5 \text{ GeV}^2 \leq -k^2 \leq \text{GeV}^2$.

II. GENERAL FORMALISM FOR THE DESCRIPTION OF $e + d \rightarrow e + d + P^0$ PROCESSES

A. Derivation of the cross section

The general structure of the differential cross section for the $e + d \rightarrow e + d + P^0$ reaction can be established in the framework of the one-photon mechanism (Fig. 1) by using only the most general symmetry properties of the hadronic electromagnetic interaction, such as gauge invariance (the conservation of hadronic and leptonic electromagnetic currents) and invariance upon mirror symmetry (parity invariance of the strong and electromagnetic interactions or, in short, P -invariance). The details of the reaction mechanism and the deuteron structure do not contribute at this step.

The transition matrix element can be written:

$$\begin{aligned} \mathcal{M}(ed \rightarrow edP) &= \frac{e^2}{k^2} \bar{u}(k_2) \gamma_\mu u(k_1) \langle dP | \hat{\mathcal{J}}_\mu | d \rangle \equiv \frac{e^2}{k^2} \ell_\mu \mathcal{J}_\mu, \\ \ell_\mu &\equiv \bar{u}(k_2) \gamma_\mu u(k_1), \mathcal{J}_\mu \equiv \langle dP | \hat{\mathcal{J}}_\mu | d \rangle, \end{aligned} \quad (1)$$

where the notations of the particle four-momenta are explained in Fig. 1 and \mathcal{J}_μ is the electromagnetic current for the transition $\gamma^* + d \rightarrow d + P^0$. Using the conservation of leptonic and hadronic currents, ($k \cdot \mathcal{J} = k \cdot \ell = 0$) one can rewrite the matrix element in terms of space-like components of currents only :

$$\mathcal{M} = \frac{e^2}{k^2} \vec{e} \cdot \vec{\mathcal{J}}, \vec{e} \equiv \vec{\ell} - \vec{k} \frac{\vec{k} \cdot \vec{\ell}}{k_0^2},$$

where $k = (k_0, \vec{k})$, k_0 is the energy, \vec{k} is the three-momentum of the virtual photon in the CMS of $\gamma^* + d \rightarrow d + P^0$. All observables will be determined by bilinear combinations of the components of the hadronic current $\vec{\mathcal{J}}$: $H_{ab} = \mathcal{J}_a \mathcal{J}_b^*$. As a result, we obtain the following formula for the exclusive differential cross section in terms of the tensor components H_{ab} :

$$\begin{aligned} \frac{d^3\sigma}{dE_2 d\Omega_e d\Omega_p} &= \frac{\alpha^2}{64\pi^3} \frac{E_2}{E_1} \frac{|\vec{q}|}{M\sqrt{s}} \frac{1}{1 - \kappa} \frac{X}{(-k^2)}, \\ X &= H_{xx} + H_{yy} + \kappa \cos 2\varphi (H_{xx} - H_{yy}) - 2\kappa \frac{k^2}{k_0^2} H_{zz} \end{aligned}$$

$$-\sqrt{2\kappa(1+\kappa)\frac{(-k^2)}{k_0^2}}[\cos\varphi(H_{xz}+H_{zx})-\sin\varphi(H_{yz}+H_{zy})] \quad (2)$$

$$+\kappa\sin 2\varphi(H_{xy}+H_{yx})-\lambda\sqrt{1-\kappa}[\sqrt{1+\kappa}(H_{xy}-H_{yx})-\sqrt{2\kappa\frac{(-k^2)}{k_0^2}}$$

$$(\sin\varphi(H_{xz}-H_{zx})-\cos\varphi(H_{yz}-H_{zy}))],$$

where $\kappa^{-1} = 1 - 2\vec{k}_L^2 t g^2 \frac{\theta_e}{2} / k^2$ is the polarization of the virtual photon. Here $E_1(E_2)$ is the energy of the initial (final) electron in the lab system; θ_e is the electron scattering angle in the lab; $d\Omega_e$ is the solid angle of the scattered electron in the lab system; $d\Omega_p$ and \vec{q} are respectively the solid angle and three-momentum of the produced P^0 -meson in the CMS ; M is the target mass; \vec{k}_L is the photon three-momentum in the lab system; $\lambda = \pm 1$ for the two possible initial electron helicities; φ is the azimuthal angle of the scattered electron with respect to the plane of the reaction $\gamma^* + d \rightarrow d + P^0$. The coordinate system is such that the z -axis is along \vec{k} and the xz plane is defined by \vec{k} and \vec{q} .

The tensor structure of $H_{ab} = \overline{\mathcal{J}_a \mathcal{J}_b^*}$ (where the line denotes the sum over the final deuteron polarizations) can be written in the following form:

$$H_{ab} = H_{ab}^{(0)} + H_{ab}^{(1)} + H_{ab}^{(2)}, \quad (3)$$

where the indexes (0), (1) and (2) correspond to unpolarized, vector and tensor polarized initial deuterons, respectively. The first term $H_{ab}^{(0)}$ can be parametrized as:

$$H_{ab}^{(0)} = \hat{m}_a \hat{m}_b h_1 + \hat{n}_a \hat{n}_b h_2 + \hat{k}_a \hat{k}_b h_3 + \{\hat{m}, \hat{k}\}_{ab} h_4 + i [\hat{m}, \hat{k}]_{ab} h_5, \quad (4)$$

with $\{\hat{m}, \hat{k}\}_{ab} = \hat{m}_a \hat{k}_b + \hat{m}_b \hat{k}_a$, $[\hat{m}, \hat{k}]_{ab} = \hat{m}_a \hat{k}_b - \hat{m}_b \hat{k}_a$. Here $h_1 - h_5$ are the real SF's, which depend on k^2 , s and t , $\hat{n} = \vec{k} \times \vec{q} / |\vec{k} \times \vec{q}|$, $\hat{m} = \hat{n} \times \hat{k}$, $\hat{k} = \vec{k} / |\vec{k}|$. The SF's $h_1 - h_4$ determine the cross section for the reaction $e + d \rightarrow e + d + P^0$ with unpolarized particles. The SF h_5 (the so-called "fifth" structure function) determines the asymmetry of longitudinally polarized electrons scattered by an unpolarized target. This T -odd contribution is determined by the product of longitudinal and transverse components of the hadron electromagnetic current

and it is nonzero only for noncoplanar kinematics, $\varphi \neq 0$. This contribution is very sensitive to the details of the final state interaction.

The tensor $H_{ab}^{(1)}$ is linear in the pseudovector \vec{S} (vector polarization of the initial deuteron) and can be written in the following general form:

$$\begin{aligned}
H_{ab}^{(1)} = & \hat{m} \cdot \vec{S} (\{\hat{m}, \hat{n}\}_{ab} h_6 + \{\hat{k}, \hat{n}\}_{ab} h_7 + i[\hat{m}, \hat{n}]_{ab} h_8 + i[\hat{k}, \hat{n}]_{ab} h_9) \\
& + \hat{n} \cdot \vec{S} (\hat{m}_a \hat{m}_b h_{10} + \hat{n}_a \hat{n}_b h_{11} + \hat{k}_a \hat{k}_b h_{12} + \{\hat{m}, \hat{k}\}_{ab} h_{13} + i[\hat{m}, \hat{k}]_{ab} h_{14}) \\
& + \hat{k} \cdot \vec{S} (\{\hat{m}, \hat{n}\}_{ab} h_{15} + \{\hat{k}, \hat{n}\}_{ab} h_{16} + i[\hat{m}, \hat{n}]_{ab} h_{17} + i[\hat{k}, \hat{n}]_{ab} h_{18}).
\end{aligned} \tag{5}$$

So, 13 real SF's $h_6 - h_{18}$ describe the effects of the vector target polarization for the exclusive cross section in the one-photon approximation. The symmetric (antisymmetric) part of $H_{ab}^{(1)}$ determines the scattering of unpolarized (polarized) electrons by a vector-polarized target. In particular, it is the symmetric part of $H_{ab}^{(1)}$, which induces T -odd asymmetries in the $\vec{d}(e, e' P^0)d$ reaction.

The integration of the tensor $H_{ab}^{(1)}$ over $d\Omega_p$ can be done in the following way, typical for inclusive polarized electron-hadron collisions ¹:

$$\int H_{ab}^{(1)} d\Omega_p = i\varepsilon_{abc} S_c w_3 + i\varepsilon_{abc} \hat{k}_c \vec{S} \cdot \hat{k} w_4 + \left(\hat{k}_a \left[\hat{k} \times \vec{S} \right]_b + \hat{k}_b \left[\hat{k} \times \vec{S} \right]_a \right) w_5.$$

For the inclusive structure functions $w_3 - w_5$ one obtains the following expressions in terms of integrals of the linear combinations of SF's h_i :

$$\begin{aligned}
w_3 &= \int (-h_9 - h_{14} + h_{17}) d\Omega_p, \\
w_3 + w_4 &= \int h_{17} d\Omega_p, \\
w_5 &= \int (h_7 - h_{13}) d\Omega_p,
\end{aligned} \tag{6}$$

i. e. most of the exclusive SF' 's $h_6 - h_{18}$ do not contribute to the inclusive SF' 's $w_3 - w_5$.

¹Note, that for an unpolarized deuteron target the following formula holds: $\int H_{ab}^{(0)} d\Omega_p = \delta_{ab} w_1 + \hat{k}_a \hat{k}_b w_2$.

Finally, for the tensor $H_{ab}^{(2)}$, characterizing the effects of the tensor target polarization, it is possible to write the following general expression :

$$\begin{aligned}
H_{ab}^{(2)} = & (Q_{cd}\hat{m}_c\hat{m}_d)(\hat{m}_a\hat{m}_bh_{19} + \hat{n}_a\hat{n}_bh_{20} + \hat{k}_a\hat{k}_bh_{21} + \{\hat{m}, \hat{k}\}_{ab}h_{22} + i[\hat{m}, \hat{k}]_{ab}h_{23}) \\
& + (Q_{cd}\hat{n}_c\hat{n}_d)(\hat{m}_a\hat{m}_bh_{24} + \hat{n}_a\hat{n}_bh_{25} + \hat{k}_a\hat{k}_bh_{26} + \{\hat{m}, \hat{k}\}_{ab}h_{27} + i[\hat{m}, \hat{k}]_{ab}h_{28}) \\
& + (Q_{cd}\hat{m}_c\hat{k}_d)(\hat{m}_a\hat{m}_bh_{29} + \hat{n}_a\hat{n}_bh_{30} + \hat{k}_a\hat{k}_bh_{31} + \{\hat{m}, \hat{k}\}_{ab}h_{32} + i[\hat{m}, \hat{k}]_{ab}h_{33}) \quad (7) \\
& + (Q_{cd}\hat{m}_c\hat{n}_d)(\{\hat{m}, \hat{n}\}_{ab}h_{34} + \{\hat{k}, \hat{n}\}_{ab}h_{35} + i[\hat{m}, \hat{n}]_{ab}h_{36} + i[\hat{k}, \hat{n}]_{ab}h_{37}) \\
& + (Q_{cd}\hat{k}_c\hat{n}_d)(\{\hat{m}, \hat{n}\}_{ab}h_{38} + \{\hat{k}, \hat{n}\}_{ab}h_{39} + i[\hat{m}, \hat{n}]_{ab}h_{40} + i[\hat{k}, \hat{n}]_{ab}h_{41}),
\end{aligned}$$

where Q_{ij} is a tensor polarization component of the deuteron target, $Q_{ii} = 0$, $Q_{ij} = Q_{ji}$, so the density matrix for the initial deuteron can be written as follows:

$$D_{1a}D_{1b}^* = \frac{1}{3} \left(\delta_{ab} - \frac{3}{2}i\varepsilon_{abc}S_c - Q_{ab} \right). \quad (8)$$

Therefore, for exclusive reactions like $A(e, e)A'h$, in the framework of the one-photon mechanism, the effects of the target tensor polarization are characterized by a set of 23 real SF's, $h_{19} - h_{41}$. However the result of the integration of this tensor over the angle $d\Omega_p$ of the P^0 -meson reduces its dependence to 5 real structure functions only :

$$\begin{aligned}
\int H_{ab}^{(2)}d\Omega_p = & (Q_{cd}\hat{k}_c\hat{k}_d) \left[w_6 (\delta_{ab} - \hat{k}_a\hat{k}_b) + w_7\hat{k}_a\hat{k}_b \right] \\
& + Q_{ab}w_8 + (Q_a\hat{k}_b + Q_b\hat{k}_a) w_9 + i (Q_a\hat{k}_b - Q_b\hat{k}_a) w_{10}, \quad Q_a = Q_{ab}\hat{k}_b.
\end{aligned}$$

In summary, the exclusive differential cross section for unpolarized electron scattering in $e^- + d \rightarrow e^- + d + P$ is determined by a set of 28 ($4_0 + 8_1 + 16_2 = 28$) SF's, where the indexes 0, 1 and 2 correspond to unpolarized target (0), target with vector (1) and tensor (2) polarizations. For longitudinally polarized electron scattering there are additional $1_0 + 5_1 + 7_2 = 13$ SF's. These 41 SF's can be divided alternatively into 5 - describing electron scattering by an unpolarized deuteron target, 13 - describing the effect of the vector deuteron polarization and 23 - depending on the tensor deuteron polarization. Taking into account the T-invariance of the electromagnetic interaction of hadrons, we can classify the set of 41

SF's in $1_0 + 8_1 + 7_2 = 16$ T-odd structures and $4_0 + 5_1 + 16_2 = 25$ T-even SF, as illustrated in Table 1.

For inclusive hadron electro-production, the number of SF's reduces to two ($w_1 - w_2$) for the unpolarized case, three ($w_3 - w_5$), describing deuteron vector polarization effects and five ($w_6 - w_{10}$), depending on the tensor polarization.

This analysis takes into account the eventual vector and tensor polarizations of the target but not the polarization of the produced particles since a summation over the final polarization states has been done. It can be easily generalized to any other polarization observables such as the recoil deuteron polarization or the spin correlation coefficients. A thorough formal treatment of polarization phenomena can be done in other ways, see, for example, [22].

B. Amplitude analysis

The next step in this analysis, is to establish the spin structure of the matrix element for the $\gamma^* + d \rightarrow d + P^0$ reaction without any constraint on the kinematical conditions.

This spin structure of the amplitude can be parametrized by different (and equivalent) methods, but for the analysis of polarization phenomena the choice of *transverse amplitudes* is sometimes preferable. Taking into account the P -invariance of the electromagnetic interaction of hadrons, the dependence of the amplitude of $\gamma^* + d \rightarrow d + P^0$ on the γ^* polarization and polarization three-vectors \vec{D}_1 and \vec{D}_2 of the initial and final deuterons is given by:

$$\begin{aligned}
F(\gamma^* d \rightarrow d P^0) = & \vec{e} \cdot \hat{m} (g_1 \hat{m} \cdot \vec{D}_1 \hat{n} \cdot \vec{D}_2^* + g_2 \hat{k} \cdot \vec{D}_1 \hat{n} \cdot \vec{D}_2^* + g_3 \hat{n} \cdot \vec{D}_1 \hat{m} \cdot \vec{D}_2^* + g_4 \hat{n} \cdot \vec{D}_1 \hat{k} \cdot \vec{D}_2^*) \\
& + \vec{e} \cdot \hat{n} (g_5 \hat{m} \cdot \vec{D}_1 \hat{m} \cdot \vec{D}_2^* + g_6 \hat{n} \cdot \vec{D}_1 \hat{n} \cdot \vec{D}_2^* + g_7 \hat{k} \cdot \vec{D}_1 \hat{k} \cdot \vec{D}_2^* + g_8 \hat{m} \cdot \vec{D}_1 \hat{k} \cdot \vec{D}_2^* + g_9 \hat{k} \cdot \vec{D}_1 \hat{m} \cdot \vec{D}_2^*) \\
& + \vec{e} \cdot \hat{k} (g_{10} \hat{m} \cdot \vec{D}_1 \hat{n} \cdot \vec{D}_2^* + g_{11} \hat{k} \cdot \vec{D}_1 \hat{n} \cdot \vec{D}_2^* + g_{12} \hat{n} \cdot \vec{D}_1 \hat{m} \cdot \vec{D}_2^* + g_{13} \hat{n} \cdot \vec{D}_1 \hat{k} \cdot \vec{D}_2^*), \quad (9)
\end{aligned}$$

The process $\gamma^* + d \rightarrow d + P^0$ is described in the general case, by a set of 9 amplitudes for the absorption of a virtual photon with transverse polarization and 4 amplitudes for the

absorption of a virtual photon with longitudinal polarization. These numbers are dictated by the values of the spins of the particles and by the P-invariance of hadron electrodynamics. Taking into account the possible helicities for γ^* and deuterons (in the initial and final states) one can find $3 (\gamma^*) \times 3 (\text{initial deuteron}) \times 3 (\text{final deuteron}) = 27$ different transitions in $\gamma^* + d \rightarrow d + P^0$ and 27 corresponding helicity amplitudes $f_{\lambda_\gamma; \lambda_1; \lambda_2}$, where λ_i are the corresponding helicities. Not all these amplitudes are independent, due to the following relations: $f_{-\lambda_\gamma; -\lambda_1; -\lambda_2} = -(-1)^{\lambda_\gamma - \lambda_1 - \lambda_2} f_{\lambda_\gamma; \lambda_1; \lambda_2}$, which result from the P-invariance. It is then possible to find that $f_{00,0} = 0$ and that it remains only 13 independent complex amplitudes. Therefore the complete experiment requires, at least, the measurement of 25 observables. Let us mention in this respect specific properties of polarization phenomena for inelastic electron-hadron scattering: in exclusive $e + d \rightarrow e + d + P^0$ processes the virtual photon has a nonzero linear polarization, even for the scattering of unpolarized electrons by an unpolarized deuteron target. Therefore, the study of the φ - and κ -dependences of the $d(e, eP^0)d$ differential cross section - at a fixed values of the dynamical variables s , t and k^2 - allows, in principle, to find not a single, but 4 different quadratic combinations of scalar amplitudes simultaneously: h_1, h_2, h_3 and h_4 . The relationships between the structure functions $h_i, i = 1 - 4$, and the amplitudes $g_k, k = 1 - 13$, are given in the Appendix.

III. THE $\gamma^* + d \rightarrow d + P^0$ REACTION AT THRESHOLD

A. Derivation of the cross section

The threshold region is defined here as the γ^* energy region in which P^0 -meson production occurs in a S-state. This region may be wide as it happens in $\gamma + N \rightarrow N + \eta$ or very narrow as in $\gamma + p \rightarrow p + \pi^0$. This region starts from $s = (M + m_P)^2$, where m_P is the mass of the produced pseudoscalar meson, but the momentum transfer squared k^2 can take any value in the space-like region ($k^2 \leq 0$).

For threshold P^0 -meson production only one three-momentum, \vec{k} , is present (instead of

two: \vec{k} and \vec{q} , in the general case) and the full kinematics of the produced hadronic system is fixed by the kinematical conditions of the scattered electron only, similarly to elastic ed -scattering. For S-wave production any angular dependence in $\gamma^* + d \rightarrow d + \pi^0$ disappears. The inclusive cross section is obtained by integrating the differential cross section (2):

$$\frac{d^2\sigma}{dE_2 d\Omega_e} = \frac{\alpha^2 E_2}{16\pi^2 E_1} \frac{|\vec{q}|}{M\sqrt{s}} \frac{1}{1-\kappa} \frac{X^{(t)}}{(-k^2)},$$

$$X^{(t)} = H_{xx}^{(t)} + H_{yy}^{(t)} + \kappa (H_{xx}^{(t)} - H_{yy}^{(t)}) - 2\kappa \frac{k^2}{k_0^2} H_{zz}^{(t)} - \sqrt{2\kappa(1+\kappa)} \frac{(-k^2)}{k_0^2} (H_{xz}^{(t)} + H_{zx}^{(t)})$$

$$- \lambda \sqrt{1-\kappa} \left(\sqrt{1+\kappa} (H_{xy}^{(t)} - H_{yx}^{(t)}) + \sqrt{2\kappa \frac{(-k^2)}{k_0^2}} (H_{yz}^{(t)} - H_{zy}^{(t)}) \right), \quad (10)$$

where the superscript (t) stands for threshold.

The hadronic tensor $H_{ab}^{(t)}$, for the case of polarized deuteron target, can be written as :

$$H_{ab}^{(t)} = (\delta_{ab} - \hat{k}_a \hat{k}_b) t_1(k^2) + \hat{k}_a \hat{k}_b t_2(k^2) + i\varepsilon_{abc} S_c t_3(k^2) + i\varepsilon_{abc} \hat{k}_c \vec{S} \cdot \vec{k} t_4(k^2)$$

$$+ [\hat{k}_a (\vec{k} \times \vec{S})_b + \hat{k}_b (\vec{k} \times \vec{S})_a] t_5(k^2) + (\vec{Q} \cdot \vec{k}) [(\delta_{ab} - \hat{k}_a \hat{k}_b) t_6(k^2) + \hat{k}_a \hat{k}_b t_7(k^2)]$$

$$+ Q_{ab} t_8(k^2) + (Q_a \hat{k}_b + Q_b \hat{k}_a) t_9(k^2) + i(Q_a \hat{k}_b - Q_b \hat{k}_a) t_{10}(k^2). \quad (11)$$

The quantities $t_i(k^2)$, $i = 1 - 10$, are real structure functions, which are bilinear combinations of threshold electromagnetic form factors which will be defined in the next section.

The symmetrical part of the tensor $H_{ab}^{(t)}$ determines the differential threshold cross section for the scattering of unpolarized electrons (by polarized and unpolarized deuterons), and the antisymmetrical part characterizes the scattering of longitudinally polarized electrons.

B. Amplitude analysis

Taking into account the P -invariance of the hadronic electromagnetic interaction, the following threshold multipole transitions for $\gamma^* + d \rightarrow d + P^0$ are allowed:

$$E1_\ell, E1_t \text{ and } M2 \rightarrow \mathcal{J}^P = 1^-,$$

where \mathcal{J} and P are respectively the total angular momentum and parity of the γ^*d system. Therefore, threshold P^0 -electroproduction is characterized by two transitions with absorption of electric dipole virtual photons (with longitudinal ℓ and transverse t polarizations) and one transition with absorption of magnetic quadrupole (transverse only) virtual photons.

The threshold amplitude of the process $\gamma^* + d \rightarrow d + P^0$ can be parametrized in the following way:

$$\begin{aligned}
F_{th} = & \left(\vec{e} \cdot \vec{D}_1 \times \vec{D}_2^* - \vec{e} \cdot \hat{k} \vec{D}_1 \times \vec{D}_2^* \cdot \hat{k} \right) f_{1t}(k^2) \\
& + \vec{e} \cdot \hat{k} \vec{D}_1 \times \vec{D}_2^* \cdot \hat{k} f_{1l}(k^2) \\
& + \left(\vec{e} \times \hat{k} \cdot \vec{D}_1 \hat{k} \cdot \vec{D}_2^* + \vec{e} \times \hat{k} \cdot \vec{D}_2^* \hat{k} \cdot \vec{D}_1 \right) f_2(k^2),
\end{aligned} \tag{12}$$

where \vec{e} is the polarization of the virtual γ -quantum.

The form factor $f_{1t}(k^2)$ [$f_{1l}(k^2)$] describes the absorption of electric dipole virtual photons with transverse [longitudinal] polarization and the form factor $f_2(k^2)$, the absorption of a magnetic quadrupole γ -quantum. They have the same fundamental meaning as the elastic electromagnetic form factors of the deuteron.

Generally they are complex functions of k^2 , due to the unitarity condition (Fig. 2) in the variable s (with a $n+p$ system in an intermediate state with both nucleons on the mass shell). But their relative phases have to be equal to 0 or π , as a result of T -invariance of hadron electrodynamics (theorem of Christ and Lee [33]). In general, they depend also on the s variable, so that $f_i(k^2) \rightarrow f_i(k^2, s)$.

In order to have a full reconstruction of the spin structure for $\gamma^* + d \rightarrow d + P^0$, polarization measurements are necessary. A simple one is the tensor polarization of the scattered deuteron (or the tensor analyzing power using a polarized deuteron target).

After summing over the polarization states of the final deuterons the following expressions can be obtained for the threshold $SF' s t_1 - t_{10}$ in terms of the electromagnetic threshold form factors $f_{1t}(k^2)$, $f_{1l}(k^2)$ and $f_2(k^2)$:

$$3t_1(k^2) = 2 \left(|f_{1t}(k^2)|^2 + |f_2(k^2)|^2 \right),$$

$$\begin{aligned}
3t_2(k^2) &= 2 \left| f_{1\ell}(k^2) \right|^2, \\
t_3(k^2) &= -\frac{1}{2} \mathcal{R}e f_{1\ell}(k^2) \left(f_{1t}(k^2) + f_2(k^2) \right)^*, \\
t_4(k^2) &= -\frac{1}{2} \left| f_{1t}(k^2) - f_2(k^2) \right|^2 + \frac{1}{2} \mathcal{R}e f_{1\ell} \left(f_{1t}(k^2) + f_2(k^2) \right)^*, \\
t_5(k^2) &= -\frac{1}{2} \mathcal{I}m f_{1\ell}(k^2) \left(f_{1t}(k^2) + f_2(k^2) \right)^*, \\
3t_6(k^2) &= -4 \mathcal{R}e f_{1t}(k^2) f_2^*(k^2), \\
3t_7(k^2) &= \left| f_{1t}(k^2) - f_2(k^2) \right|^2 - 2 \mathcal{R}e f_{1\ell}(k^2) \left(f_{1t}(k^2) + f_2(k^2) \right)^*, \\
3t_8(k^2) &= \left| f_{1t}(k^2) - f_2(k^2) \right|^2, \\
3t_9(k^2) &= -\left| f_{1t}(k^2) - f_2(k^2) \right|^2 + \mathcal{R}e f_{1\ell}(k^2) \left(f_{1t}(k^2) + f_2(k^2) \right)^*, \\
3t_{10}(k^2) &= -\mathcal{I}m f_{1\ell}(k^2) \left(f_{1t}(k^2) + f_2(k^2) \right)^*. \tag{13}
\end{aligned}$$

This a strong simplification compared to the 41 real SF's, depending on 13 complex amplitudes, which are necessary in the general case.

The $SF t_5(k^2)$ is related to the asymmetry of unpolarized electrons scattered by a vector polarized deuteron target (with polarization orthogonal to the electron scattering plane), while the SF $h_{10}(k^2)$ is related to the asymmetry of longitudinally polarized electrons scattered by a deuteron target with tensor polarization. These two SF' s are determined by the interference of the longitudinal ($f_{1\ell}(k^2)$) and both transverse (f_{1t} and f_2) form factors of the threshold transition $\gamma^* + d \rightarrow d + P^0$. They define the T-odd polarization observables and must vanish if the relative phase of the longitudinal and transverse form factors is equal to 0 or π [33]. A dedicated experiment at SLAC [34] for the search of T-odd asymmetry of unpolarized electrons (and positrons) by a polarized proton target - with negative result - remains the best test of T-invariance in hadron electrodynamics (at moderate energies). No similar experiments have been done with a polarized deuteron target but an attempt [35] to detect a nonzero vector deuteron polarization in elastic ed -scattering has been tried, with a negative result too.

From the expressions, obtained for the SF' s in terms of the corresponding threshold form factors, one can find an optimal strategy for performing a full experiment on P^0 -meson electroproduction on deuteron near threshold. One must first perform a Rosenbluth separation for the differential cross section of unpolarized electron scattering by an unpolarized target, which allows to find the structure functions $t_1(k^2)$ and $t_2(k^2)$. These SF' s determine the total cross sections for the absorption of virtual photons with transverse and longitudinal polarizations. It is straightforward then to deduce, from the longitudinal structure function $t_2(k^2)$, the k^2 -dependence of the form factor $f_{1\ell}(k^2)$ - for absorption of electric dipole longitudinal virtual photons.

The transverse structure function $t_1(k^2)$ contains the contributions of both transverse electromagnetic form factors, namely $|f_{1t}|^2$ and $|f_2(k^2)|^2$. If we interchange the transverse and longitudinal structure functions, we have a situation similar to elastic ed -scattering : for elastic ed -scattering the transverse structure function contains only the contribution of the magnetic form factor, so its k^2 -dependence can be found directly (after a Rosenbluth fit), but the longitudinal structure function contains the contributions of the charge and quadrupole electromagnetic form factors of deuteron. To separate these contributions it is necessary to measure the tensor polarization of scattered deuterons or the tensor analyzing power [36]. From this we can conclude that the measurement of the tensor polarization of the final deuteron in $e + d \rightarrow e + d + P^0$ near threshold, will allow to separate the contributions due to $f_{1t}(k^2)$ and $f_2(k^2)$.

This procedure, however, does not give the sign of the threshold form factors. For elastic ed -scattering, using the well known values of the static electromagnetic characteristics of the deuteron : its electric charge, magnetic and quadrupole moments, it is possible to extrapolate the sign step by step for any values of the momentum transfer square k^2 . We can use the same method for $\gamma^* + d \rightarrow d + P^0$, using at $k^2 = 0$ the signs of the amplitude for $\gamma + d \rightarrow d + P^0$ which can be deduced, in principle, from the signs of the threshold amplitudes for the elementary processes $\gamma + N \rightarrow N + P^0$.

We can also find the sign of the $f_{1t}(k^2)$, $f_{1\ell}(k^2)$ and $f_2(k^2)$ form factors at any value k^2 by using their relation with the form factors of the $\gamma^* + N \rightarrow N + P^0$ reactions at threshold. The matrix element for S-wave P^0 -meson production on a nucleon can be parametrized in terms of two form factors, namely :

$$\mathcal{F}(\gamma^* N \rightarrow NP^0) = \chi_2^+ [(\vec{\sigma} \cdot \vec{e} - \vec{e} \cdot \hat{k} \vec{\sigma} \cdot \hat{k}) f_t(k^2) + f_\ell(k^2) \vec{e} \cdot \hat{k} \vec{\sigma} \cdot \hat{k}] \chi_1, \quad (14)$$

where χ_1 and χ_2 are the two component spinors of the initial and final nucleons ; $f_t(k^2)$ and $f_\ell(k^2)$ are the threshold electromagnetic form factors, corresponding to the absorption of electric dipole virtual photons with transverse and longitudinal polarizations. At $k^2 = 0$, $f_\ell(0) = 0$ and $f_t(0) = E_{0+}$ is the threshold electric dipole amplitude for $\gamma + N \rightarrow N + \pi$ (with real photons).

In the framework of the *IA* (Fig. 3) the form factors $f_{1t}(k^2)$, $f_{1\ell}(k^2)$ and $f_2(k^2)$ for $\gamma^* + d \rightarrow d + P^0$ can be directly related to the form factors $f_\ell(k^2)$ and $f_t(k^2)$ for $\gamma^* + N \rightarrow N + P^0$.

IV. IMPULSE APPROXIMATION

The most conventional starting point of possible mechanisms for pion electroproduction on the deuteron is the *IA*. This is, for example, the main mechanism in the region of Δ -excitation, where the rescattering effects for $\gamma + d \rightarrow d + \pi^0$ are negligible [30,31]. A special attention has to be devoted to the threshold region, for $\gamma(\gamma^*) + d \rightarrow d + \pi^0$, in particular for pion electroproduction in S-state where the rescattering effects may play an important role. Nevertheless, it is possible to show, in a model independent way, using only the Pauli principle, that the main rescattering contribution due to the following two step process: $\gamma + d \rightarrow p + p + \pi^-$ (and $n + n + \pi^+$) $\rightarrow d + \pi^0$ vanishes, when the two nucleons in the $NN\pi$ -intermediate state are on mass shell. We plan to discuss this problem in a separate paper.

A. Relationship between the $\gamma^* + d \rightarrow d + P^0$ and $\gamma^* + N \rightarrow N + P^0$ amplitudes

In the framework of *IA* (Fig. 3), the matrix element $\mathcal{M}(\gamma^* d \rightarrow d P^0)$ for the $\gamma^* + d \rightarrow d + P^0$ process can be written:

$$\begin{aligned} \mathcal{M} &= 2 \int d^3 \vec{p} \mathcal{T} r \varphi^+ \left(\left| \vec{p} + \frac{1}{4} \vec{Q} \right| \right) \hat{F} \varphi \left(\left| \vec{p} - \frac{1}{4} \vec{Q} \right| \right), \\ \vec{Q} &= \vec{k} - \vec{q}, \quad 2\vec{p} = \vec{p}_1 - \vec{p}_2 + \frac{1}{2} \vec{Q}, \end{aligned} \quad (15)$$

where $\vec{P}_1 = \vec{p}_1 + \vec{p}_2$, $\vec{P}_2 = \vec{p}_1' + \vec{p}_2'$, and $\vec{k} + \vec{p}_1 = \vec{q} + \vec{p}_1'$ (the notation is explained in Fig. 3),

$$\begin{aligned} F(\gamma N \rightarrow N P^0) &= \chi_2^+ \hat{F} \chi_1, \\ \hat{F} &= (\vec{\sigma} \cdot \vec{K} + L) / 2 \end{aligned} \quad (16)$$

and \vec{K} , L are the spin-dependent and spin-independent contributions to the matrix \hat{F} .

For the deuteron wave function we shall use the following representation, which takes into account the *S*- and *D*-waves in the *np*-system :

$$\begin{aligned} \varphi(\vec{p}) &= \frac{1}{(2\pi)^{\frac{3}{2}}} \int d^3 \vec{r} e^{-i\vec{p}\vec{r}} \varphi(r), \\ \varphi(r) &= \frac{1}{\sqrt{4\pi}} \left[\vec{\sigma} \cdot \vec{D} \frac{u(r)}{r} + \frac{w(r)}{\sqrt{2}r} \left(3 \frac{\vec{\sigma} \cdot \vec{r} \vec{D} \cdot \vec{r}}{r^2} - \vec{\sigma} \cdot \vec{D} \right) \right] \frac{i\sigma_2}{\sqrt{2}}, \end{aligned} \quad (17)$$

where $u(r)$ and $w(r)$ are the standard wave functions of the *S*- and *D*-states in deuteron. Expression (15) is particularly convenient to establish the spin structure of the amplitude of the $\gamma^* + d \rightarrow d + P^0$ process. Since in general the amplitudes \vec{K} and L (for the processes $\gamma^* + N \rightarrow N + P^0$) depend on the integration momentum \vec{p} in (15), the wave functions u and w of the initial and final deuteron will not depend on the same variable. Indeed, due to the nonlocality of $\gamma^* N \rightarrow N P^0$ vertex, the coordinates \vec{r} and \vec{r}' of the initial and final deuterons do not coincide. However, choosing the \vec{K} and L amplitudes at a particular value of the internal momentum \vec{p}_1 , \hat{F} can be taken outside the integration symbol. This allows to express the quantity \mathcal{M} in terms of a definite combination of deuteron form factors, multiplied by the isovector (isoscalar) amplitudes for the $\gamma^* + N \rightarrow N + \pi^0$ ($\gamma^* + N \rightarrow N + \eta$) reaction (*factorization hypothesis*).

This procedure is usually justified by a rapid fall-off of $\varphi(|\vec{p}|)$ when $|\vec{p}|$ increases and by a (relatively) weak dependence of the \vec{K} and L amplitudes on $|\vec{p}|$ [16].

Let us discuss shortly how to determine the most suitable nucleon Fermi momentum. It is natural to compare the $\gamma^* + d \rightarrow d + P$ and $\gamma^* + N \rightarrow N + P$ amplitudes at the same values of two variables, namely k^2 and t . The choice is still open for the variable $s = (k + p_1)^2$. The simplest prescription - to set $s_1 = m^2 + k^2 + 2mk_0$ (where m is the nucleon mass and k_0 is the virtual photon energy in lab system of γ^*d -collisions) - does not work. Indeed, when both nucleons in the reaction $\gamma + N \rightarrow N + P$ are on the mass shell, then for a given value k_0 , the intervals of t -variation in the reactions $\gamma + N \rightarrow N + P$ and $\gamma + d \rightarrow d + P$ are not the same : in order to realize for $\gamma + N \rightarrow N + P$ the interval of t -variation, characteristic for $\gamma^* + d \rightarrow d + P$, it is necessary to go outside the physical region in $\cos \theta^*$ (namely, $|\cos \theta^*| > 1$), (where θ^* is the angle between the momenta γ^* and P in the CMS of the reaction $\gamma + N \rightarrow N + P$.) This difficulty can be avoided increasing correspondingly the value of the variable s_1 which is favoured by the Fermi-motion of the nucleons in the deuteron.

This prescription, obviously, does not give a unique value for the momentum \vec{P}_1 . However, the condition that both nucleons for the process $\gamma^* + N \rightarrow N + P$ are on mass shell, leads to the following relation between the components P_{1x} and P_{1z} (in case of real photon with $k^2 = 0$) :

$$P_{1z} (AQ_z - BQ_0) / 2 (Q_0^2 - Q_z^2), \quad Q_0 = k - \omega, \quad Q_z = k - q \cos \theta,$$

$$A = Q^2 + 2P_{1x}Q_x, \quad B^2 = A^2 + 4 (Q_x^2 - Q_0^2) (m^2 + P_{1x}^2), \quad (18)$$

where θ is the angle between the momenta of γ and P in the CMS of $\gamma + d \rightarrow d + P$, and ω is the P-meson energy in this system.

Let us remind that the xz plane is chosen as the plane of the reaction $\gamma + d \rightarrow d + P$, the z axis is directed along the momentum of the γ , and all the momenta lie in the xz plane. The component P_{1x} will be fixed by one of the conditions :

$$P_{1x} = 0, \quad (19)$$

$$P_{1x} = q \sin \theta / 2, \quad (20)$$

$$P_{1x} = q \sin \theta / 4. \quad (21)$$

Using Eq. 18, one can find the corresponding value of P_{1z} .

The momenta, defined by Eqs. (19-21), lie in the kinematical region which gives the largest contribution to the matrix element of the $\gamma + d \rightarrow d + P$ process (the presence of such region is due to the fact that the deuteron wave function falls off rapidly with the increasing of P_i or P_f -corresponding arguments of initial and final deuteron wave functions).

In the literature another choice of \vec{P}_1 has been used (more simple than (18)) :

$$\vec{P}_1 = -\vec{k}/2, \quad (22)$$

$$\vec{P}_1 = -\frac{3\vec{k}}{4} + \frac{\vec{q}}{4} \quad (23)$$

The choice (22) corresponds to minimum of P_i , and the choice (23) to $P_i = P_f$. Of course, in the general case the *I.A.* $\gamma + d \rightarrow d + P^0$ amplitude should be determined by the $\gamma + N^* \rightarrow N^* + P$ amplitudes, with two virtual nucleons N^* , $m_i \neq m_f \neq m$. However, such amplitudes are not known yet.

In our calculation we will use the CMS of the virtual photon and the participant nucleon N_P , so that $\vec{k} + \vec{p}_1 = 0$, considering the effective mass W of the $\gamma^* N_P$ -system and the pion production angle in $\gamma^* + N_P \rightarrow \pi + N$ as the arguments of the elementary amplitudes ².

After some transformations, Eq. (15) becomes:

$$\begin{aligned} \mathcal{M}(\gamma^* d \rightarrow d P^0) = & \vec{D}_1 \vec{D}_2^* \hat{L} F_1(\vec{Q}^2) + 2 \left(3 \vec{D}_1 \cdot \hat{\vec{Q}} \vec{D}_2^* \cdot \vec{Q} - \vec{D}_1 \cdot \vec{D}_2 \right) \hat{L} F_2(\vec{Q}^2) \\ & + i \hat{\vec{K}} \cdot \vec{D}_1 \times \vec{D}_2^* \left(F_3(\vec{Q}^2) + F_4(\vec{Q}^2) \right) - 3i \hat{\vec{K}} \cdot \hat{\vec{Q}} \hat{\vec{Q}} \cdot \vec{D}_1 \times \vec{D}_2^* F_4(\vec{Q}^2), \quad (24) \end{aligned}$$

²The analysis of the sensitivity of the different observables for the process $\gamma + d \rightarrow d + \pi^0$ to the different choices of \vec{p}_1 can be found in [16]

with $\hat{Q} = (\vec{k} - \vec{q}) / |\vec{k} - \vec{q}|$, where \hat{K} and \hat{L} are the values of K and L for a definite value of \vec{p}_1 (see below).

The generalized deuteron form factors $F_i(Q^2)$ are defined by :

$$\begin{aligned}
F_1(Q^2) &= \int_0^\infty dr j_0\left(\frac{Qr}{2}\right) [u^2(r) + w^2(r)], \\
F_2(Q^2) &= \int_0^\infty dr j_2\left(\frac{Qr}{2}\right) \left[u(r) - \frac{w(r)}{\sqrt{8}}\right] w(r), \\
F_3(Q^2) &= \int_0^\infty dr j_0\left(\frac{Qr}{2}\right) \left[u^2(r) - \frac{1}{2}w^2(r)\right], \\
F_4(Q^2) &= \int_0^\infty dr j_2\left(\frac{Qr}{2}\right) \left[u(r) + \frac{1}{\sqrt{2}}w(r)\right] w(r), \\
j_0(x) &= \frac{\sin x}{x}, \quad j_2(x) = \sin x \left(\frac{3}{x^3} - \frac{1}{x}\right) - 3\frac{\cos x}{x^2}.
\end{aligned} \tag{25}$$

The combinations of the deuteron wave functions $u(r)$ and $w(r)$ in $F_i(Q^2)$ define the charge, the magnetic and quadrupole form factors of the deuteron. The fourth form factor F_4 in Eqs. (25) is associated with a nonconservation of the current of the transition $d \rightarrow d + \pi^0$, due to the specific structure of the triangle diagram contribution.

The calculated form factors, $F_i(Q^2)$, using Bonn [40] and Paris [41] deuteron wave functions, are shown in Fig. 4.

The quantity Q^2 characterizes the value of the four-momentum transfer squared t in the $\gamma^* + d \rightarrow d + P^0$ reaction,

$$t = (k - q)^2 = 2M \left(M - \sqrt{M^2 + Q^2} \right),$$

so that $t \equiv -Q^2$, when $|Q| \ll M$.

Obviously, the structure of the $\gamma^* + d \rightarrow d + P^0$ amplitude, Eq. (24), is not the most general one, even in the case of arbitrary values of \hat{K} and L and deuteron form factors $F_i(Q^2)$. Let us consider first the general spin structure of the amplitude for $\gamma^* + N \rightarrow N + P^0$ process :

$$\begin{aligned}
\mathcal{M}(\gamma^* N \rightarrow N \pi) &= \chi_2^\dagger \mathcal{F} \chi_1, \\
\mathcal{F} &= i\vec{e} \cdot \hat{k} \times \hat{q} f_1 + \vec{\sigma} \cdot \vec{e} f_2 + \vec{\sigma} \cdot \hat{k} \vec{e} \cdot \hat{q} f_3 + \vec{\sigma} \cdot \hat{q} \vec{e} \cdot \hat{q} f_4
\end{aligned} \tag{26}$$

$$+\vec{e} \cdot \hat{k} (\vec{\sigma} \cdot \hat{k} f_5 + \vec{\sigma} \cdot \hat{q} f_6),$$

where $f_i = f_i(s_1, t, k^2)$ are the scalar amplitudes for $\gamma^* + N \rightarrow N + P^0$, so that

$$L = i f_1 \vec{e} \cdot \hat{k} \times \hat{q},$$

$$\vec{K} = \vec{e} \cdot f_2 + \hat{k} \left(\vec{e} \cdot \hat{q} f_3 + \vec{e} \cdot \hat{k} f_5 \right) + \hat{q} \left(\vec{e} \cdot \hat{q} f_4 + \vec{e} \cdot \hat{k} f_6 \right). \quad (27)$$

Comparing the expression (24) for the amplitude $\mathcal{M}(\gamma^* d \rightarrow d P^0)$ in *IA* with the general spin structure of the amplitude one can establish a definite connection between both sets of scalar amplitudes, namely g_i , $i = 1 - 13$, for $\gamma^* + d \rightarrow d + P^0$ (on one side) and f_k , $k = 1 - 6$, for $\gamma^* + N \rightarrow N + P^0$ (on another side). Their exact relations are given below:

$$g_1 = -g_3 = \sin \theta (f_3 + \cos \theta f_4) \left(F_3 (\vec{Q}^2) + F_4 (\vec{Q}^2) \right)$$

$$- 3 Q_k (Q_m f_2 + Q_k \sin \theta f_3 + Q_q \sin \theta f_4) F_4 (\vec{Q}^2),$$

$$g_2 = -g_4 = -(f_2 + \sin^2 \theta f_4) \left(F_3 (\vec{Q}^2) + F_4 (\vec{Q}^2) \right)$$

$$+ 3 Q_m (Q_m f_2 + Q_k \sin \theta + Q_q \sin \theta f_4) F_4 (\vec{Q}^2),$$

$$g_5 = \sin \theta f_1 \left[F_1 (\vec{Q}^2) + 2 F_2 (\vec{Q}^2) (3 Q_m^2 - 1) \right],$$

$$g_6 = \sin \theta f_1 \left[F_1 (\vec{Q}^2) - 2 F_2 (\vec{Q}^2) \right],$$

$$g_7 = \sin \theta f_1 \left[F_1 (\vec{Q}^2) + 2 F_2 (\vec{Q}^2) (3 Q_k^2 - 1) \right],$$

$$g_8 = 6 \sin \theta Q_m Q_k f_1 F_2 (\vec{Q}^2) - f_2 \left(F_3 (\vec{Q}^2) + F_4 (\vec{Q}^2) \right),$$

$$g_9 = 6 \sin \theta Q_m Q_k f_1 F_2 (\vec{Q}^2) + f_2 \left(F_3 (\vec{Q}^2) + F_4 (\vec{Q}^2) \right),$$

$$g_{10} = -g_{12} = (f_2 + f_3 \cos \theta + f_4 \cos^2 \theta + f_5 + f_6 \cos \theta) \left(F_3 (\vec{Q}^2) + F_4 (\vec{Q}^2) \right)$$

$$- 3 Q_k [Q_k (f_2 + f_3 \cos \theta + f_5) + Q_q (\cos \theta f_4 + f_6)] F_4 (\vec{Q}^2),$$

$$g_{11} = -g_{13} = -\sin \theta (\cos \theta f_4 + f_6) [F_3 (\vec{Q}^2) + F_4 (\vec{Q}^2)] + 3 Q_m [Q_k (f_2 + \cos \theta f_3 + f_5) +$$

$$Q_q (\cos \theta f_4 + f_6)] F_4 (\vec{Q}^2),$$

where $Q_m = \hat{Q} \cdot \hat{m}$, $Q_k = \hat{Q} \cdot \vec{k}$, $Q_m^2 + Q_k^2 = 1$, $Q_m^2 = \sin^2 \theta \frac{q^2}{|\vec{k} - \vec{q}|^2}$, and θ is the P^0 -meson production angle in *CMS* of $\gamma^* + d \rightarrow d + P^0$ process.

Note that the relations $g_1 + g_3 = g_2 + g_4 = g_{10} + g_{12} = g_{11} + g_{13} = 0$, which are correct for any amplitude f_k , result from the factorization hypothesis.

Neglecting the D -wave contribution, we can predict that the following ratios:

$$\begin{aligned} \left(H_{xx}^{(0)} - H_{yy}^{(0)} \right) / \left(H_{xx}^{(0)} + H_{yy}^{(0)} \right)_0 &= \left(|f_3|^2 + |f_4|^2 - |f_1|^2 - |f_2|^2 \right) / \left(|f_1|^2 + |f_2|^2 + |f_3|^2 + |f_4|^2 \right), \\ \left(H_{zz}^{(0)} \right) / \left(H_{xx}^{(0)} + H_{yy}^{(0)} \right)_0 &= \left(|f_5|^2 + |f_6|^2 \right) / \left(|f_1|^2 + |f_2|^2 + |f_3|^2 + |f_4|^2 \right), \end{aligned} \quad (28)$$

which do not depend on deuteron form factors and therefore on the deuteron structure.

V. MODEL FOR $\gamma^* + N \rightarrow N + \pi^0$

In order to calculate the scalar amplitudes g_i , $i = 1 - 13$, for the $\gamma^* + d \rightarrow d + \pi^0$ process in framework of IA , it is necessary to know the \vec{Q}^2 -dependence of the deuteron form factors $F_j(Q^2)$, $j = 1 - 4$, from one side, and the elementary amplitudes f_k , $k = 1 - 6$, for the process $\gamma^* + N \rightarrow N + \pi^0$, from another side. In order to calculate the isovector part of the amplitudes f_k for $\gamma^* + N \rightarrow N + \pi^0$, we shall use the effective Lagrangian approach-with a standard set of contributions (Fig. 5). Such approach [42] has successfully reproduced the experimental data [43], for the process $e + p \rightarrow e + p + \pi^0$ in the following kinematical conditions: $1.1 \leq W \leq 1.4$ GeV and $-k^2 = 2.8$ and 4.0 GeV², in the whole domain of $\cos \vartheta_\pi$ and azimuthal angle ϕ . The main ingredients of this calculation were the s- and u-channel contributions of N and Δ , with particular attention to the 'off-shell' properties of the Δ -isobar. The comparison with the experimental data allowed to determine the following values of the electromagnetic form factors for the $\gamma^* + p \rightarrow \Delta^+$ transition:

$$G_M^*/3G_d, \quad G_d = (1 - k^2/0.71 \text{ GeV}^2)^{-2}, \quad R_{EM} = E_{1+}/M_{1+}, \quad R_{SM} = S_{1+}/M_{1+},$$

where M_{1+} , E_{1+} and S_{1+} denote the magnitude of the magnetic dipole, electric (transversal) quadrupole and Coulomb (longitudinal) quadrupole amplitudes or transition form factors for the $\gamma^* + N \rightarrow \Delta$ excitation. In our analysis we will use the two following results of the experiment [43]:

- The magnetic dipole form factor $G_M^*(k^2)$ dominates, i.e. the ratios R_{EM} and R_{SM} are small (in absolute value);
- The magnetic dipole form factor G_M^* decreases with $-k^2$ faster than the dipole formula.

We parametrize the inelastic magnetic form factor $G_M^*(k^2) \equiv G(k^2)$ for the $N \rightarrow \Delta$ electromagnetic transition with the help of the following formula:

$$G(k^2) = \frac{G(0)G_d(k^2)}{(1 - k^2/m_x^2)}.$$

Using the last experimental data about the ratio $G(k^2)/3G_d$ we find $m_x^2 = 5.75 \text{ GeV}^2$, in agreement with previous estimates [44].

Note in this connection, that the new JLab data [45] about the electric proton form factor $G_{Ep}(k^2)$ show also a deviation from the dipole formula, with a similar value of the parameter m_x .

In order to calculate the amplitudes f_i , $i = 1, \dots, 6$, for the elementary processes $e^- + N \rightarrow e^- + N + \pi^0$, $N = p$ or n , we will use a model similar to [46] but with the following modifications:

- we introduce a term describing the exchange of ω -meson in the t -channel;
- the s -channel contribution of the Δ isobar is parametrized in such a form to avoid any off-mass shell effects (such as the admixture of $1/2^\pm$ or $3/2^-$ states).
- the u -channel of the Δ -isobar is neglected.

In order to justify the last option, let us note the essential difference between the u -channel contributions of N and Δ . The necessity to introduce the u -channel contribution from the proton exchange in the process $\gamma^* + p \rightarrow p + \pi^0$ is dictated by the gauge invariance of the electromagnetic interaction. As a byproduct, it derives the crossing symmetry for the resulting $s + u$ proton exchange. In case of Δ -exchange, there is a different situation with respect to the above mentioned symmetry properties: the gauge invariance and the crossing symmetry. Due to the non-diagonality of the electromagnetic transition

$\gamma^* + N \rightarrow \Delta$, it is possible to parametrize this vertex in a gauge invariant form independently from the virtuality of the Δ . Therefore, the Δ -contribution only in the s -channel, is gauge invariant, independently from the u -channel Δ -contribution. This means that for the Δ -contribution there is no direct connection between the gauge invariance and the crossing symmetry, as for the proton exchange. Moreover, even the Δ -contribution in s - and u -channels simultaneously will not induce crossing symmetry. Namely due to the presence of the Δ -pole in the physical region of s -channel, it is necessary to introduce the Δ -width in the corresponding propagator- with resulting complex amplitudes, whereas the u -channel Δ -contribution is characterized by real amplitudes. It turns out that we do not have exact crossing symmetry for the Δ -contributions, even for the sum of u - and s diagrams with Δ -exchange. An exact calculation of the u -channel Δ -contribution can be found in [42]. Such calculation involves 3 off-mass-shell parameters which can not be predicted by theory, starting from a composit model of hadrons. They show a large dependence on the unitarization method, and are strongly correlated. Their determination from experimental data can not be done uniquely. Moreover, the experimental data on $\gamma p \rightarrow p\pi^0$ in the Δ -region show an angular dependence according to a $5 - 3\cos^2\theta$ -distribution, which indicates a predominance of the s -channel contribution.

Therefore we will consider only the s - channel Δ -contribution. In order to avoid problems with off-mass shell effects, we write the matrix element for the Δ -contribution following the two-component formalism for the description of the spin structure of both vertices, $\Delta \rightarrow N + \pi$ and $\gamma^* + N \rightarrow \Delta$. Therefore we can write:

$$\gamma + N \rightarrow \Delta : \vec{e} \times \vec{k} \cdot \vec{\chi}^\dagger \mathcal{I} \chi_1, \quad \text{M1 transition, only!}$$

$$\Delta \rightarrow N + \pi : \chi_2^\dagger \mathcal{I} \vec{\chi} \cdot \vec{q},$$

where \mathcal{I} is the identity matrix. Each component of the vector $\vec{\chi}$ is a 2-component spinor, satisfying the condition $\vec{\sigma} \cdot \vec{\chi} = 0$, in order to avoid any spin 1/2 contribution. Using for the Δ density matrix the following expression:

$$\rho_{ab} = \frac{2}{3}(\delta_{ab} - \frac{i}{2}\epsilon_{abc}\sigma_c),$$

we can write the matrix element for the Δ -contribution in the CMS of $\gamma^* + N \rightarrow N + \pi^0$ as follows:

$$\mathcal{M}_\Delta = \frac{eG(k^2)|\vec{q}|}{M_\Delta^2 - s - i\Gamma_\Delta M_\Delta} \chi_2^\dagger (2i\vec{e} \cdot \hat{k} \times \hat{q} + \cos\vartheta_\pi \vec{\sigma} \cdot \vec{e} - \vec{\sigma} \cdot \hat{k} \vec{e} \cdot \hat{q}) \chi_1 \sqrt{(E_1 + m)(E_2 + m)}, \quad (29)$$

where M_Δ (Γ_Δ) is the mass (width) of Δ .

The following Δ contributions to the scalar amplitudes, $f_{i\Delta}$, $i = 1 - 6$, can be derived:

$$\begin{aligned} f_{1\Delta} &= 2\Pi(s, k^2), \\ f_{2\Delta} &= \cos\vartheta_\pi \Pi(s, k^2), \\ f_{3\Delta} &= -\Pi(s, k^2), \\ f_{4\Delta} &= f_{5\Delta} = f_{6\Delta} = 0, \end{aligned} \quad (30)$$

where we use the notation:

$$\Pi(s, k^2) = \frac{G(k^2)|\vec{q}|}{M_\Delta^2 - s - i\Gamma_\Delta M_\Delta}.$$

The normalization constant $G(0)$ can be deduced from the value of the total cross section for the reaction $\gamma + p \rightarrow p + \pi^0$ (with real photons) at $s = M_\Delta^2$:

$$\sigma_T(\gamma p \rightarrow p\pi^0) = \frac{\alpha}{2} G^2(0) \frac{|\vec{q}|^3}{|\vec{k}|} \frac{(E_{1\Delta} + m)(E_{2\Delta} + m)}{M_\Delta^4 \Gamma_\Delta^2},$$

where

$$\begin{aligned} E_{1\Delta} &= \frac{M_\Delta^2 + m^2}{2M_\Delta}, & E_{2\Delta} &= \frac{M_\Delta^2 + m^2 - m_\pi^2}{2M_\Delta}, \\ |\vec{k}| &= \frac{M_\Delta^2 - m^2}{2M_\Delta}, & |\vec{q}| &= \sqrt{E_{2\Delta}^2 - m^2}. \end{aligned}$$

Using the spin structure of the resonance amplitude (29), we obtain the following structure for the resonance contribution to the matrix element of the process $\gamma^* + d \rightarrow d + \pi^0$:

$$\mathcal{M}_\Delta(\gamma^* d \rightarrow d\pi) = \frac{1}{2} \Pi(s, k^2) \left\{ 2 \sin\theta \vec{e} \cdot \hat{n} \left[F_1(\vec{Q}^2) \vec{D}_1 \cdot \vec{D}_2^* + F_2(\vec{Q}^2) (3\vec{D}_1 \cdot \hat{Q} \vec{D}_2^* \cdot \hat{Q} - \vec{D}_1 \cdot \vec{D}_2^*) \right] \right\}$$

$$+ \left[(\vec{e} \cdot \hat{m} \hat{m} \cdot \vec{D}_1 \times \vec{D}_2^* + \vec{e} \cdot \hat{n} \hat{n} \cdot \vec{D}_1 \times \vec{D}_2^*) \cos \theta - \vec{e} \cdot \hat{q} \hat{k} \cdot \vec{D}_1 \times \vec{D}_2^* \right] (F_3(Q^2) + F_4(Q^2)) \\ - 3 \cos \theta F_4(Q^2) \vec{e} \cdot \hat{m} \hat{Q} \cdot \vec{D}_1 \times \vec{D}_2^* Q_m + 3 F_4(Q^2) \vec{e} \cdot \hat{q} \hat{Q} \cdot \vec{D}_1 \times \vec{D}_2^* Q_k \}.$$

Taking into account only the S-wave component of the deuteron wave function it is possible to predict the θ -dependence for the simplest polarization observables for $\gamma^* + d \rightarrow d + \pi^0$:

$$(H_{xx}^{(0)} - H_{yy}^{(0)}) / (H_{xx}^{(0)} + H_{yy}^{(0)}) = -3 \frac{\sin^2 \theta}{3 - 2 \cos^2 \theta}, \quad H_{xz}^{(0)} = H_{zz}^{(0)} = 0.$$

and in the case of tensor polarized deuterons :

$$(H_{xx}^{(2)} + H_{yy}^{(2)}) / (H_{xx}^{(0)} + H_{yy}^{(0)})_0 = -Q_{zz} \frac{\cos^2 \theta}{4(3 - 2 \cos^2 \theta)}, \\ (H_{xx}^{(2)} - H_{yy}^{(2)}) / (H_{xx}^{(0)} + H_{yy}^{(0)})_0 = (Q_{xx} - Q_{yy}) \frac{\cos^2 \theta}{4(3 - 2 \cos^2 \theta)}.$$

For comparison, note that in the case of the process $e + p \rightarrow e + p + \pi^0$ we have (for an unpolarized proton target):

$$(H_{xx}^{(0)} - H_{yy}^{(0)}) / (H_{xx}^{(0)} + H_{yy}^{(0)}) = -\frac{5 \sin^2 \theta}{5 - 3 \cos^2 \theta}.$$

The matrix element \mathcal{M}_ω for the ω -exchange in $\gamma^* + N \rightarrow N + \pi^0$ can be written in the following form:

$$\mathcal{M}_\omega = \frac{g_\omega G_\omega(k^2)}{m_\omega(t - m_\omega^2)} \epsilon_{\mu\nu\rho\sigma} e_\mu k_\nu q_\sigma u(p_2) \left[\gamma_\rho - \frac{\kappa_\omega}{2m} \sigma_{\rho\beta} (k - q)_\beta \right] u(p_1)$$

The constants κ_ω and g_ω are fixed by the Bonn potential [40]: $\kappa_\omega = 0$, $g_\omega^2/4\pi = 20$. The VDM suggests the following parametrization for the form factor $G_\omega(k^2)$:

$$G_\omega(k^2) = \frac{G_\omega(0)}{1 - k^2/m_\rho^2}.$$

The value $G_\omega(0)$ can be fixed by the width of the radiative decay $\omega \rightarrow \pi\gamma$, through the following formula:

$$\Gamma(\omega \rightarrow \pi\gamma) = \frac{\alpha}{24} G_\omega^2(0) \left(1 - \frac{m_\pi^2}{m_\omega^2}\right)^3 m_\omega,$$

where $BR(\omega \rightarrow \pi^0\gamma) = \Gamma(\omega \rightarrow \pi^0\gamma)/\Gamma_\omega = (8.5 \pm 1.5)\%$, $\Gamma_\omega = (8.81 \pm 0.09)$ MeV and $m_\omega = 782$ MeV.

Concerning vector meson exchange in $e^- + N \rightarrow e^- + N + \pi$, it is known [46], that the vector meson exchange is important for the processes $\gamma + N \rightarrow N + \pi$, in the considered region of W . Due to the isovector nature of the electromagnetic current in $\gamma^* + d \rightarrow d + \pi^0$, the ρ^0 -contribution to $\gamma^* + N \rightarrow N + \pi^0$ is exactly cancelled. The VDM parametrization of the electromagnetic form factors suggested above for the $\gamma^*\pi\omega$ -vertex as to be considered as a simplified possibility for the space-like region of momentum transfer, where there is no experimental information. However, in the region of time-like momentum transfer, different pieces of information exist. Let us mention three of them. The decay $\omega \rightarrow \pi + \ell^+ + \ell^-$ [47] allows to measure this form factor in the following region $4m_\ell \leq k^2 \leq (m_\omega - m_\pi)^2$, where m_ℓ is the lepton mass. The process $e^+ + e^- \rightarrow \pi^0 + \omega$ [48] is driven by the considered form factor in another time-like region, namely for $k^2 \geq (m_\omega + m_\pi)^2$. For completeness we mention the $\tau^- \rightarrow \nu_\tau + \pi^- + \omega$ decay [49]. The presence of the same factor $G_\omega(k^2)$ in processes so different as $e^+ + e^- \rightarrow \pi^0 + \omega$ and $\tau \rightarrow \nu_\tau + \pi^- + \omega$ results from the well known CVC hypothesis (Conservation of Vector Current for the weak semileptonic processes).

Note also that we have taken a 'hard' expression for the VDM form factor, $G_\omega(k^2)$, which is assumed to reproduce at best the structure function $A(k^2)$ of elastic ed scattering, through the calculations of the meson exchange current due to $\pi\rho$ exchange [50]. However this conclusion is correlated to the properties of the nucleon form factor, especially with the behavior of the isoscalar electric form factor, $G_{Es} = (G_{Ep} + G_{En})/2$. New G_{Ep} data [45] (with large deviation from the previously assumed dipole behavior) will also favor a hard form factor $G_\omega(k^2)$ for the good description of the k^2 dependence of $A(k^2)$ at large momentum transfer. However a satisfactory description will depend also on the large k^2 -dependence of the neutron electric form factors, which will be measured in the next future up to $|k^2| = 2 \text{ GeV}^2$ [51]. It is then expected that the different observables in the processes $e + N \rightarrow e + N + \pi^0$ and $e + d \rightarrow e + d + \pi^0$ at relatively large momentum transfer are sensitive to the parametrizations of the form factor $G_\omega(k^2)$. For example, the VDM parametrization for $G_\omega(k^2)$ shows that this form factor is 'harder' in comparison with nucleon and $N \rightarrow \Delta$ form factors. Therefore, in this case, the relative role of ω -exchange will be essentially

increased at large momentum transfer.

VI. RESULTS AND DISCUSSION

In order to test the model for π^0 electroproduction on deuterons, we compared our calculation to experimental data on π^0 and π^+ photoproduction on proton in the Δ -resonance region. The angular distributions at different energies of the real photon reproduce quite well the existing data, a sample of which is shown in Fig. 6. This agreement justifies the generalization of the model in case of π^0 -electroproduction on nucleons, $e^- + N \rightarrow e^- + N + \pi^0$, by introducing the corresponding electromagnetic form factors in the different photon-hadron vertices (see Fig. 5). Note also, that the resulting electromagnetic current for the process $\gamma^* + N \rightarrow N + \pi^0$ (with virtual photon) still satisfies the gauge invariance, for any parametrization of the electromagnetic form factors, and for any values of the kinematical variables k^2 , W and $\cos \vartheta_\pi$. However this model does not satisfy the T-invariance of the electromagnetic interaction, but here we will consider only T-even observables, such as the different contributions to the $d(e, e\pi^0)d$ differential cross section (with unpolarized particles in the initial and final states). This problem, which is common to all modern approaches of pion photo- and electro-production on nucleons, is generally not discussed in the literature.

In the framework of IA , as it was shown before, the deuteron structure is described by four inelastic form factors $F_i(\vec{Q}^2)$, $i = 1-4$, where the argument \vec{Q}^2 depends on all the three kinematical variables, k^2 , W and $\cos \vartheta_\pi$, which characterize the process $\gamma^* + N \rightarrow N + \pi$:

$$\vec{Q}^2 = (\vec{k} - \vec{q})^2 = \vec{k}^2 + \vec{q}^2 - 2|\vec{k}||\vec{q}|\cos \vartheta_\pi,$$

with

$$\begin{aligned} \vec{k}^2 &= k_0^2 - k^2, & k_0 &= \frac{W^2 + k^2 - m^2}{2W}, \\ \vec{q}^2 &= E_\pi^2 - m_\pi^2, & E_\pi &= \frac{W^2 + m_\pi^2 - m^2}{2W}. \end{aligned}$$

Fig. 7 illustrates the dependence of the variable \vec{Q}^2 on $\cos \vartheta_\pi$ at fixed values of k^2 and W , at $W=1.2$ GeV and $W=1.137$ GeV (which corresponds to $E_\gamma = 220$ MeV, see Fig. 6). This

dependence is similar for all values of k^2 , in the interval $|k^2| = 0.5 \div 2.0 \text{ GeV}^2$. Note that $\vec{Q}_{max}^2 \simeq 3 \text{ GeV}^2$ at $-k^2 = 2 \text{ GeV}^2$, so, at the same value of four momentum transfer, the process $\gamma^* + d \rightarrow d + \pi^0$ is driven by the deuteron form factors at higher momentum transfer in comparison with elastic ed -scattering.

Comparing Fig. 7 and Fig. 4 (which shows the \vec{Q}^2 -dependence of the deuteron form factors, in the interval $0 \leq \vec{Q}^2 \leq 3 \text{ GeV}^2$), one can see that in the range $-k^2 = 0.5 \div 2.0 \text{ GeV}^2$, the deuteron form factors are very sensitive to the behavior of the deuteron wave function calculated in different NN-potentials.

The θ_π -dependence of all four contributions to the inclusive $d(e, e\pi^0)d$ cross section, namely $H_{xx} \pm H_{yy}$, H_{zz} and $H_{xz} + H_{zx}$, is shown in Fig. 8 for $W = 1.137 \text{ GeV}$ and in Fig. 9 for $W = 1.2 \text{ GeV}$ ³. The different rows correspond to $-k^2 = 0.5, 1, 1.5$ and 2 GeV^2 , from top to bottom. In order to show the relative role of the different mechanisms for the elementary processes $\gamma^* + N \rightarrow N + \pi$ (in the considered kinematical region for the variables k^2 and W), each picture shows four curves: Δ contribution only, $\Delta + s + u$ (nucleon diagrams) and $\Delta + s + u \pm \omega$. The calculations are shown for both relative signs of the vector meson contribution in order to stress the importance of the ω contribution. The positive sign has been chosen from the comparison with experimental data on $\gamma + p \rightarrow p + \pi^0$ (real photons).

The ω contribution is important for all the four considered observables, in particular for the $H_{xx} \pm H_{yy}$ terms at $\theta_\pi \simeq 80^\circ$; in the case of H_{zz} the largest sensitivity appears for backward π^0 electroproduction.

The relative role of the absorption of virtual photon with longitudinal and transversal polarizations depends essentially on the variables k^2 and W , with an increase of the ratio $H_{zz}/(H_{xx} + H_{yy})$ with $-k^2$. At $W=1.2 \text{ GeV}$, where the Δ -contribution (with absorption of transversal virtual photons) dominates, the relative role of H_{zz} is weaker in comparison with $H_{xx} + H_{yy}$. However for $-k^2 \geq 1 \text{ GeV}^2$ H_{zz} exceeds $H_{xx} + H_{yy}$, even in the resonance

³Note that in our normalization, Eq. (2), all components H_{ab} are dimensionless numbers.

region.

The ratio $(H_{xx} - H_{yy})/(H_{xx} + H_{yy})$ is negative (due to the dominance of the transversal Δ and ω -contributions) and has a $\simeq \sin^2\vartheta_\pi$ behavior. The longitudinal-transversal interference contribution, $H_{xz} + H_{zx}$, shows a particular sensitivity to the different ingredients of the model, with strong ϑ_π -dependence, in the whole considered kinematical domain. In view of the importance of the ω contribution to all observables for the $d(e, e\pi^0)d$ process, we studied the sensitivity to the choice of the electromagnetic $\gamma^*\omega\pi$ -vertex form factor. For this aim we used two parametrizations, a *hard* monopole form, $G_\omega^{(h)}(k^2)$, predicted by the standard VDM, and a *soft* dipole form $G_\omega^{(s)}(k^2)$:

$$G_\omega^{(h)}(k^2) = \frac{G_\omega(0)}{1 - \frac{k^2}{m_\rho^2}}, \quad G_\omega^{(s)}(k^2) = \frac{G_\omega(0)}{\left(1 - \frac{k^2}{m_\rho^2}\right)^2}.$$

Fig. 10 shows the θ_π -dependence of the following ratios:

$$r_\pm(\cos\theta_\pi) = \frac{(H_{xx} \pm H_{yy})_{hard} - (H_{xx} \pm H_{yy})_{soft}}{(H_{xx} \pm H_{yy})_{hard} + (H_{xx} \pm H_{yy})_{soft}}$$

for two different values of k^2 ($-k^2 = 0.5$ and 2 GeV^2) and $W = 1.137$. For $W = 1.2 \text{ GeV}$ (Fig. 11) the largest sensitivity to the choice of the form factor $G_\omega(k^2)$ appears at forward angles for π^0 -production, whereas at $W = 1.137 \text{ GeV}$ all angles are equally sensitive to this choice. At the Δ -resonance this sensitivity increases slightly with $-k^2$.

The absolute measurements of the different contributions to the inclusive cross section for $d(e, e\pi^0)d$ will help in defining the appropriate k^2 -dependence of the form factor $G_\omega(k^2)$. However, as we can see on Fig. 12, the absolute values of the $H_{xx} \pm H_{yy}$ contributions, the shape and absolute values of H_{zz} and $H_{xz} + H_{zx}$ are also sensitive to the NN -potentials, in particular at large k^2 . In Figs. 13, 14, 15 and 16, we illustrate the behavior of the four observables, for different parametrizations of the following ingredients:

- the deuteron wave function: for the Bonn [40] and Paris [41] potentials,
- the electromagnetic form factors for the $\gamma^*\pi\omega$ -vertex: *hard* (VDM) and *soft* (dipole) parametrizations;

- the electromagnetic form factor of the proton: dipole or a 'softer' parametrization based on recent data on the proton electric form factor.

The differences between these parametrizations increase at large momentum transfer.

The inclusive cross section for $d(e, e)\pi^0 d$ is characterized by two contributions, only. After integration over $d\Omega_\pi$, we have:

$$H_t(k^2, W) = \int_{-1}^{+1} d \cos \vartheta_\pi (H_{xx} + H_{yy}),$$

$$H_\ell(k^2, W) = \int_{-1}^{+1} d \cos \vartheta_\pi H_{zz}.$$

The three-dimensional plot of Fig. 17 shows the dependence of these inclusive functions, on k^2 and W . The calculation is done here, for the *hard* form factor G_ω , the dipole form factor G_{Ep} and the Paris deuteron wave function.

A comparison of this calculation with the data from [3] is shown in Fig. 18. The k^2 -dependence is reported for different ranges of the variable W , from threshold to the Δ -region. The data are relative yields, integrated in the experimental acceptance, assuming constant efficiency. The agreement is quite satisfactory, in the considered domain. The theoretical curves are normalized at the largest point. They are not very sensitive to the opening of the azimuthal angle: the solid and dashed line correspond respectively to the 2π integration and to the limit for small $\Delta\phi$, which is closer to the experimental conditions. Such behavior is an indication of a weak ϕ -dependence of the $d(e, e'\pi^0)d$ cross section in this kinematical region.

VII. CONCLUSIONS

We have made a general analysis of coherent pseudoscalar neutral mesons production on deuterons, $e + d \rightarrow e + d + P^0$, which holds for any kinematics of the discussed processes. Threshold P^0 -meson production (at any value of momentum transfer square k^2 and for the minimum value of the effective mass of the produced hadronic system) is especially interesting due to the essential simplification of the spin structure of the corresponding

amplitudes and to the decreasing number of independent kinematical variables. Another kinematical region, which is interesting for the process $\gamma^* + d \rightarrow d + \pi^0$, is the Δ -isobar excitation on the nucleons.

Coherent P^0 -meson production is interesting due to its special sensitivity to the isotopic structure of the threshold amplitude for the elementary processes $\gamma^* + N \rightarrow N + P^0$.

The π^0 -meson electroproduction on the deuteron allows to measure the threshold amplitude for $\gamma^* + n \rightarrow n + \pi^0$, which is important for testing hadron electrodynamics [55].

The η -meson electroproduction on the deuteron could be important for the study of ηN - and ηd -interactions, in particular after the finding of a strong energy dependence of the cross section of $n + p \rightarrow d + \eta$ process near threshold.

The IA can be considered as a good starting point for the discussion of corrections such as mesonic exchange currents, isobar configurations in deuteron, quark degrees of freedom, etc., but rescattering effects will also have to be discussed, in particular for η -production near threshold.

Using an adequate model for the elementary processes of π^0 -electroproduction on nucleons, $e^- + N \rightarrow e^- + N + \pi^0$, which satisfactorily reproduces the angular dependence of the differential cross section for the processes $\gamma + p \rightarrow p + \pi^0$ and $\gamma + p \rightarrow n + \pi^+$ (in the Δ -resonance region), we estimated the four standard contributions to the exclusive differential cross section for the reaction $d(e, e\pi^0)d$ as functions of the variables k^2, W and ϑ_π . These calculations were done at relatively large momentum transfer square, $-k^2 = 0.5 \div 2.0 \text{ GeV}^2$, where recent data exist. All observables show a large sensitivity to the parametrization of electromagnetic form factors, in the considered model. A special attention was devoted to the study of the effects of soft and hard parametrizations of form factor for the $\pi\omega\gamma^*$ -vertex, as well as to possible deviation of the proton electric form factor from the dipole fit. Moreover, as it is well known for elastic ed -scattering, we find here, too, a large dependence of all the observables to the choice of NN -potential. The large sensitivity of the $d(e, e\pi^0)d$ cross section to the ω -exchange contribution can be used, in principle, to study the corresponding electromagnetic form factors in the space-like momentum transfer region.

The comparison of the model with the available experimental data is satisfactory. This agreement supports the two-nucleon picture of the deuteron structure in the region of relatively large momentum transfer, confirmed by the recent *ed*-elastic scattering data.

Appendix

We present here the expressions for the structure functions $h_1 - h_{41}$ in terms of the scalar amplitudes $g_1 - g_{13}$. The SF's $h_1 - h_5$ corresponding to the interaction with an unpolarized deuteron target can be written as:

$$\begin{aligned}
3h_1 &= |g_1|^2 + |g_2|^2 + |g_3|^2 + |g_4|^2, \\
3h_2 &= |g_5|^2 + |g_6|^2 + |g_7|^2 + |g_8|^2 + |g_9|^2, \\
3h_3 &= |g_{10}|^2 + |g_{11}|^2 + |g_{12}|^2 + |g_{13}|^2, \\
3h_4 &= \mathcal{R}e (g_1 g_{10}^* + g_2 g_{11}^* + g_3 g_{12}^* + g_4 g_{13}^*), \\
3h_5 &= \mathcal{I}m (g_1 g_{10}^* + g_2 g_{11}^* + g_3 g_{12}^* + g_4 g_{13}^*),
\end{aligned}$$

We derive the following expressions for the *SF's* $h_6 - h_{18}$, which characterize the effects of the target vector polarization :

$$\begin{aligned}
h_6 &= -\mathcal{I}m (g_2 g_6^* - g_3 g_9^* - g_4 g_7^*), \\
h_7 &= \mathcal{I}m (g_6 g_{11}^* + g_7 g_{13}^* + g_9 g_{12}^*), \\
h_8 &= \mathcal{R}e (g_2 g_6^* - g_3 g_9^* - g_4 g_7^*), \\
h_9 &= \mathcal{R}e (g_6 g_{11}^* - g_7 g_{13}^* - g_9 g_{12}^*), \\
h_{10} &= -2\mathcal{I}m g_1 g_2^*, \\
h_{11} &= -2\mathcal{I}m (g_5 g_9^* - g_7 g_8^*), \\
h_{12} &= -2\mathcal{I}m g_{10} g_{11}^*, \\
h_{13} &= -\mathcal{I}m (g_1 g_{11}^* - g_2 g_{10}^*), \\
h_{14} &= \mathcal{R}e (g_1 g_{11}^* - g_2 g_{10}^*),
\end{aligned}$$

$$\begin{aligned}
h_{15} &= \mathcal{I}m (g_1 g_6^* - g_3 g_5^* - g_4 g_8^*), \\
h_{16} &= \mathcal{I}m (g_5 g_{12}^* - g_6 g_{10}^* - g_8 g_{13}^*), \\
h_{17} &= -\mathcal{R}e (g_1 g_6^* - g_3 g_5^* - g_4 g_8^*), \\
h_{18} &= \mathcal{R}e (g_5 g_{12}^* - g_6 g_{10}^* + g_8 g_{13}^*),
\end{aligned}$$

Finally for the SF' s $h_{19} - h_{41}$, which describe the effects on tensor target polarization, one obtains :

$$\begin{aligned}
3h_{19} &= -|g_1|^2 + |g_2|^2 + |g_7|^2 - |g_8|^2, \\
3h_{20} &= -|g_5|^2 + |g_9|^2, \\
3h_{21} &= -|g_{10}|^2 + |g_{11}|^2, \\
3h_{22} &= -\mathcal{R}e (g_1 g_{10}^* - g_2 g_{11}^*), \\
3h_{23} &= -\mathcal{I}m (g_1 g_{10}^* - g_2 g_{11}^*), \\
3h_{24} &= |g_2|^2 - |g_3|^2 - |g_4|^2, \\
3h_{25} &= |g_6|^2 + |g_7|^2 + |g_9|^2, \\
3h_{26} &= |g_{11}|^2 - |g_{12}|^2 - |g_{13}|^2, \\
3h_{27} &= \mathcal{R}e (g_2 g_{11}^* - g_3 g_{12}^* - g_4 g_{13}^*), \\
3h_{28} &= \mathcal{I}m (g_2 g_{11}^* - g_3 g_{12}^* - g_4 g_{13}^*), \\
3h_{29} &= -2\mathcal{R}e g_1 g_2^*, \\
3h_{30} &= -2\mathcal{R}e (g_5 g_9^* + g_7 g_8^*), \\
3h_{31} &= -2\mathcal{R}e g_{10} g_{11}^*, \\
3h_{32} &= -\mathcal{R}e (g_1 g_{11}^* + g_2 g_{10}^*), \\
3h_{33} &= \mathcal{I}m (g_1 g_{11}^* + g_2 g_{10}^*), \\
3h_{34} &= -\mathcal{R}e (g_1 g_6^* + g_3 g_5^* + g_4 g_8^*), \\
3h_{35} &= -\mathcal{R}e (g_5 g_{12}^* + g_6 g_{10}^* + g_8 g_{13}^*),
\end{aligned}$$

$$3h_{36} = -\mathcal{I}m (g_1 g_6^* + g_3 g_5^* + g_4 g_8^*),$$

$$3h_{37} = \mathcal{I}m (g_5 g_{12}^* + g_6 g_{10}^* + g_8 g_{13}^*),$$

$$3h_{38} = -\mathcal{R}e (g_2 g_6^* + g_3 g_9^* + g_4 g_7^*),$$

$$3h_{39} = -\mathcal{R}e (g_6 g_{11}^* + g_7 g_{13}^* + g_9 g_{12}^*),$$

$$3h_{40} = -\mathcal{I}m (g_2 g_6^* + g_3 g_9^* + g_4 g_7^*),$$

$$3h_{41} = \mathcal{I}m (g_6 g_{11}^* + g_9 g_{12}^* + g_7 g_{13}^*).$$

REFERENCES

- [1] I. Ewald *et al.*, Phys. Lett. B **499**, 238 (2001).
- [2] S. Kox, E.J. Beise *et al.*, CEBAF proposal E-94-018.
- [3] E. Tomasi-Gustafsson *et al.*, (t_{20} collaboration),INPC, August 24-28,1998, Paris (France). Abstract of contributed papers, p. 140.
D. Abbott *et al.*, (t_{20} collaboration) Int. Rep. DAPNIA/SPhN-99-27.
- [4] W.J. Metcalf and R.L. Walker, Nucl. Phys. B **76**, 253 (1974).
- [5] I. Araj and H. Fujui, Nucl. Phys. B **194**, 251 (1982).
- [6] R.L. Crawford and W.T. Morton, Nucl. Phys. B **211**, 1 (1983).
- [7] Z. Li *et al.*, Phys. Rev. C **47**, 2759 (1993).
- [8] R.P. Feynman, M. Kisslinger and F. Ravndal, Phys. Rev. **D13**, 2706 (1971).
- [9] R. Koniuk and N. Isgur, Phys. Rev. **D21**, 1886 (1980).
- [10] Z. Li and F. E. Close, Phys. Rev. **D42**, 2207 (1990).
- [11] M. Warns, W. Pfeil and H. Rollnik, Phys. Rev. **D42**, 2215 (1990).
- [12] R. Bijker, F. Iachello and A. Leviatan, Ann. of Phys. **236**, 69 (1994);
R. Bijker, F. Iachello, and A. Leviatan, Phys. Rev. C **54**, 1935 (1996);
R. Bijker, F. Iachello, and A. Leviatan, Phys. Rev. D **55**, 2862 (1997).
- [13] B. Krusche *et al.*, Phys. Rev. Lett. **74**, 3736 (1995).
- [14] K. L. Anderson and R. Prepost, Phys. Rev. Lett. **23**, 46 (1969).
- [15] B. Krusche *et al.*, Phys. Lett. B **358**, 40 (1995).
- [16] I. V. Stoletnij and M. P. Rekalov, Sov. J. Nucl. Phys. **52**, 464 (1990).
- [17] M. P. Rekalov and I. Stoletnij, J. Phys. G.: Nucl. Part. Phys. **17**, 1643 (1991).

- [18] M. P. Rekalo and I. V. Stoletnij, J. Phys. G. : Nucl. Part. Phys. **19**, 1325 (1993).
- [19] F. Blaazer, B. L. G. Bakker, and H. J. Boersma, Nucl. Phys. **A568**, 681 (1994).
- [20] P. Wilhelm and H. Arenhovel, Nucl. Phys. **A593**, 435 (1995).
- [21] V. Bernard, H. Krebs and Ulf-G. Meissner, Phys. Rev. **C61**, 058201 (2000).
- [22] H. Arenhövel, Few-Body Syst. 25, 157 (1998); 27, 141 (1999);
Th. Ebertshäuser and H. Arenhövel, Eur. Phys. Journ. A **6**, 431 (1999).
- [23] S. R. Beane, V. Bernard, T.-S.H. Lee, Ulf-G. Meissner, V. van Kolck, Nucl. Phys. A **618**, 381 (1997).
- [24] L. C. Alexa *et al.*, Phys. Rev. C, Lett **82**, 1379 (1999).
- [25] D. G. Meekins *et al.*, Phys. Rev. **C60**, 052201 (1999).
- [26] C. W. Bochna *et al.*, Phys. Rev. Lett. **81**, 4576 (1998).
- [27] R. G. Arnold *et al.*, Phys. Rev. Lett. **35**, 776 (1975).
- [28] S. J. Brodsky and G. R. Farrar, Phys. Rev. Lett. **31**, 1153 (1973).
- [29] M. Chemtob, E. J. Moniz and M. Rho, Phys. Rev. **C10**, 344 (1974).
- [30] J. H. Koch and R. M. Woloshin, Phys. Rev. C **16**, 1968 (1977).
- [31] P. Bosted and J. M. Laget, Nucl. Phys.A **296**, 413 (1978).
- [32] G. Fäldt, Phys. Scripta **22**, 5 (1980).
- [33] N. Christ and T. D. Lee. Phys. Rev. **143**, 1310 (1966).
- [34] S. Rock *et al.*, Phys. Rev. Lett. **24**, 748 (1970).
- [35] R. Prepost, R. M. Simonds and B. H. Wiik, Phys. Rev. Lett. **21**, 1271 (1968).
- [36] R. G. Arnold, C. E. Carlson and F. Gross, Phys. Rev. **C21**, 1426 (1980).

- [37] D. Drechsel and L. Tiator, Journ. of Phys. G. **18**, 449 (1992).
- [38] H. B. van der Brink *et al.*, Nucl. Phys. **A612**, 391 (1997).
- [39] V. Bernard, N. Kaiser, T.-S.H. Lee, Ulf-G. Meissner, Phys. Rep. **246**, 315 (1994).
- [40] R. Machleidt, K. Holinde and Ch. Elster, Phys. Rep. **149**, 1 (1987).
- [41] M. Lacombe, B. Loiseau, J. M. Richard, R. Vinh Mau, Phys Rev. **C21**, 861 (1980).
- [42] R. M. Davidson, N. C. Mukhopadhyay and R. S. Wittman, Phys. Rev. **D43**, 71 (1991).
- [43] V. V. Frolov *et al.*, Phys. Rev. Lett. **82**, 45 (1999).
- [44] J. M. Laget, Nucl. Phys. **A481**, 765 (1988).
- [45] M. K. Jones *et al.*, Phys. Rev. Lett. **84**, 1398 (2000).
- [46] M. Vanderhaeghen, K. Heyde, J. Ryckebusch and M. Waroquier, Nucl. Phys. **A595**, 219 (1995).
- [47] R. I. Dzhelyadin *et al.*, Phys. Lett. **84B**, 143 (1979).
- [48] S. I. Dolinsky *et al.*, Phys. Lett. **B174**, 453 (1986).
- [49] H. Albrecht *et al.*, Phys. Lett. **260B**, 259 (1991);
D. Baskulich *et al.*, Z. Phys. **C70**, 579 (1996);
K. W. Edwards *et al.*, Phys. Rev. **D61**, 072003 (2000).
- [50] J.W. Van Orden *et al.*, Phys. Rev. Lett. **75**, 4369 (1995).
- [51] R. Madey, *The electric form factor of the neutron from the $d(\vec{e}, e'\vec{n})p$ reaction*, JLab Proposal PR-93-038.
- [52] G. Fischer, G. von Holtey, G. Knop and J. Stümpfig, Z. Phys. **253**, 38 (1972).
- [53] H. Genzel, E. Hilger, G. Knop, H. Kemen and R. Wedemeyer Z. Phys. **268**, 43 (1974).
- [54] G. Fischer, H. Fischer, G. von Holtey, H. Kämpgen, G. Knop, P. Schulz, and H. Wessels,

Z. Phys. **245**, 225 (1971).

[55] G. Ecker and U.-G. Meissner, Comments on Nucl. Part. Phys. 21, 347 (1995).

FIGURES

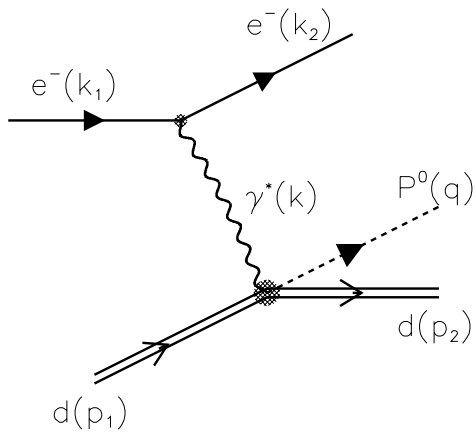

Fig. 1

FIG. 1. One-photon exchange mechanism for the process $e + d \rightarrow e + d + P^0$.

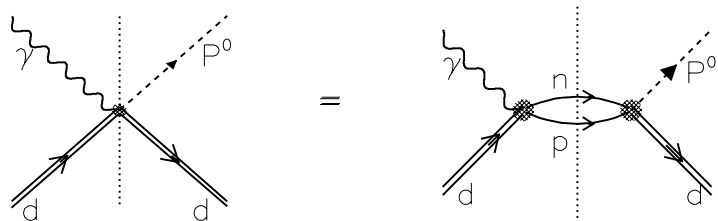

Fig. 2

FIG. 2. np -intermediate state contribution to the unitarity condition for $\gamma + d \rightarrow d + P^0$; the dotted line crosses the particles on mass shell.

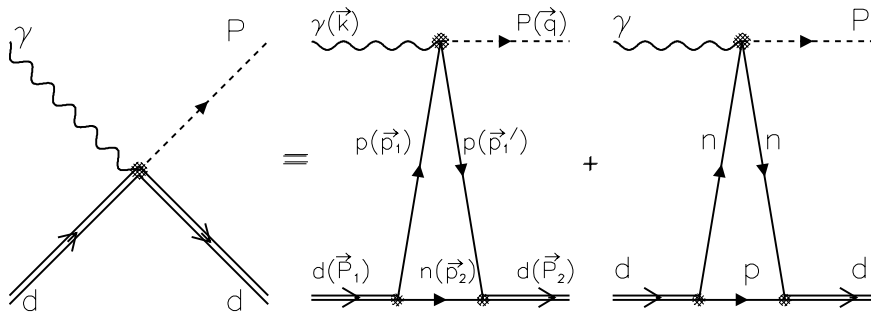

Fig. 3

FIG. 3. IA diagrams for $\gamma + d \rightarrow d + P^0$.

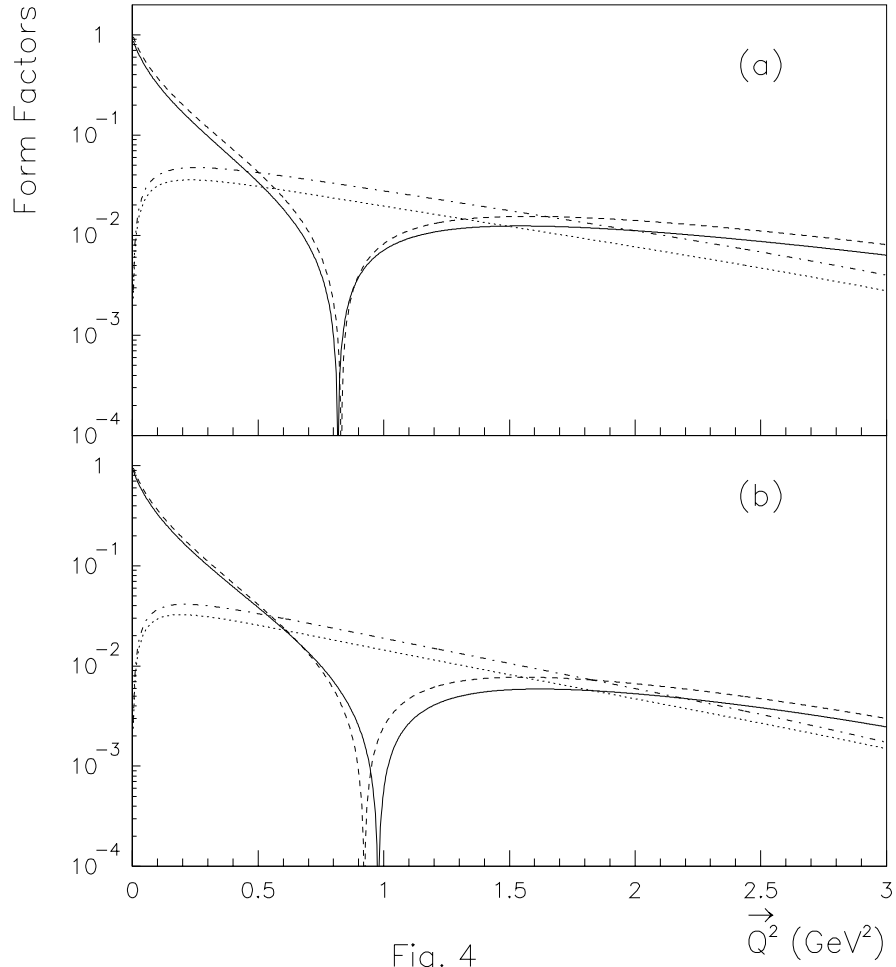

Fig. 4

FIG. 4. \vec{Q}^2 -dependence of the deuteron form factors, (see Eq. (19)) F_1 (full line), F_2 (dashed line), F_3 (dotted line), F_4 (dashed-dotted line). The calculation is based on: (a)- the Paris wave function; (b) - the Bonn wave function.

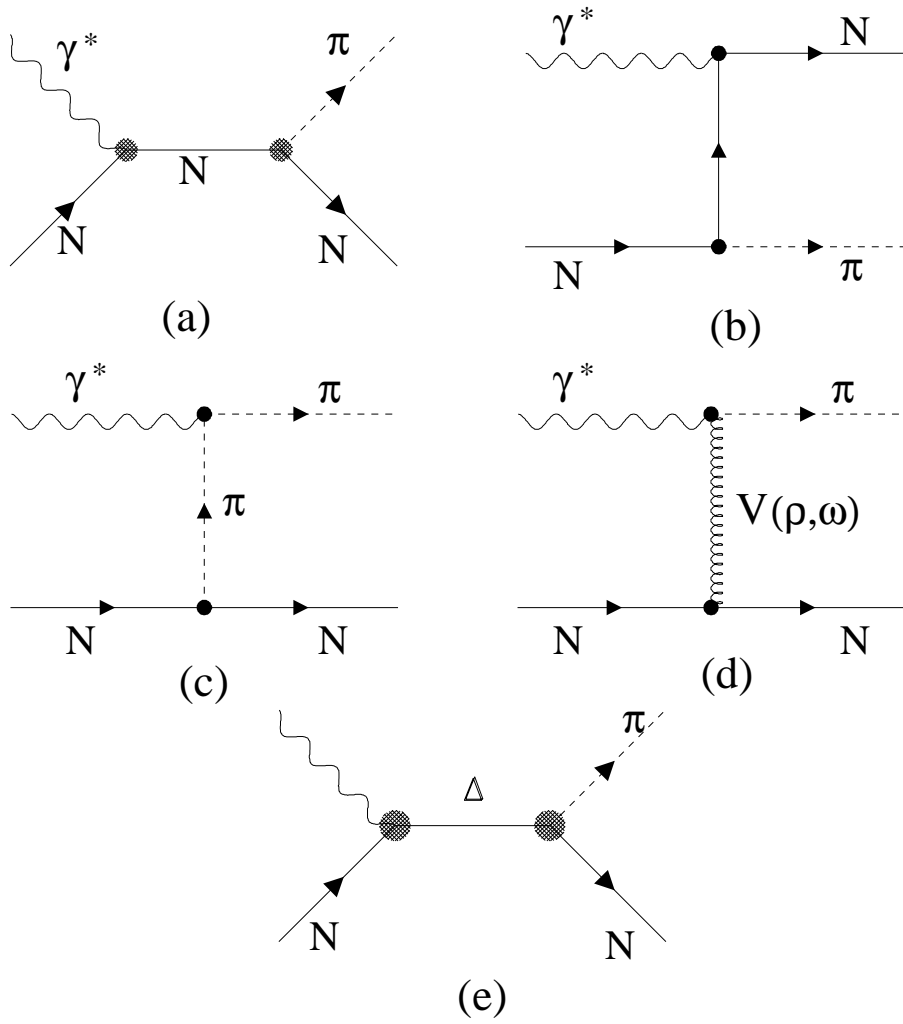

FIG. 5. The Feynman diagrams for $\gamma^* + N \rightarrow N + \pi^-$ processes

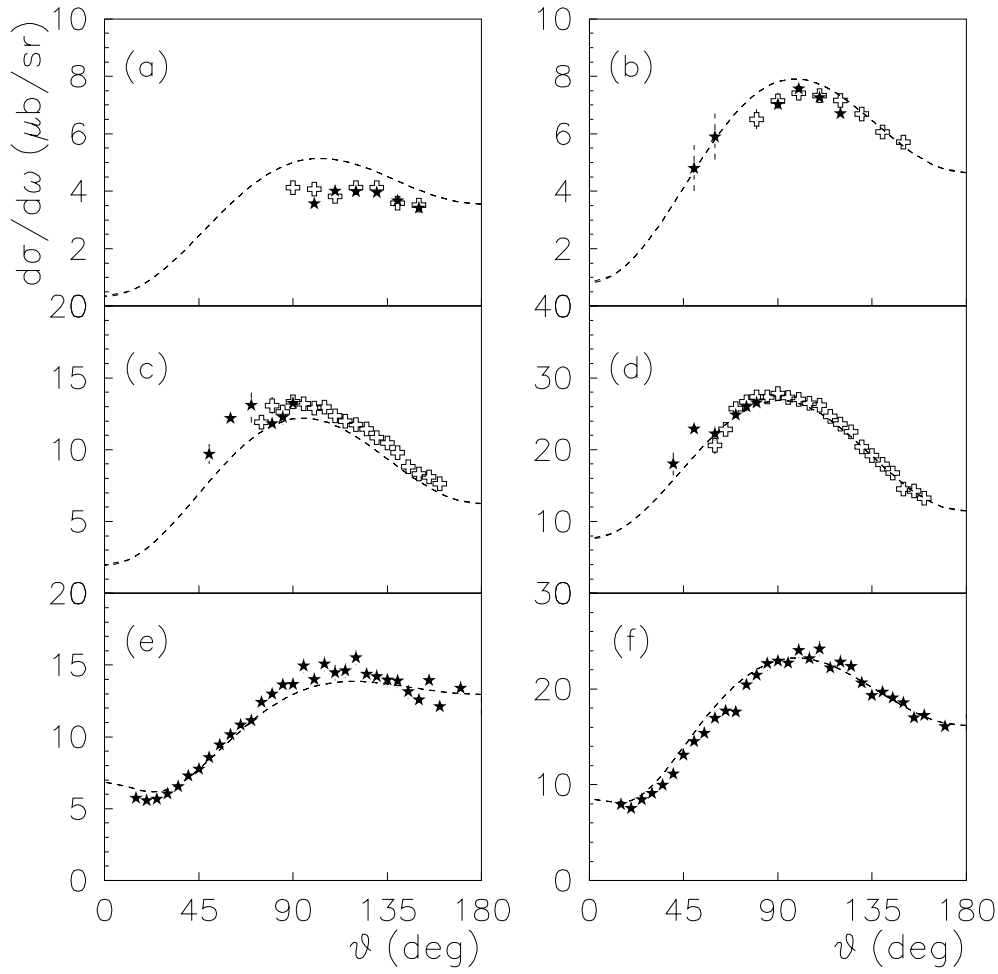

Fig. 6

FIG. 6. The angular dependence of the differential cross sections for the photoproduction processes: - $\gamma + p \rightarrow p + \pi^0$ at energy $E_\gamma=220$ MeV (a), 240 MeV (b), 260 MeV (c), 300 MeV (d); full stars (open crosses) are data from [52] ([53]); - $\gamma + p \rightarrow n + \pi^+$ at energy $E_\gamma=240$ MeV (e), 300 MeV (f); full stars are data from [54]; the dashed lines are predictions of the present model.

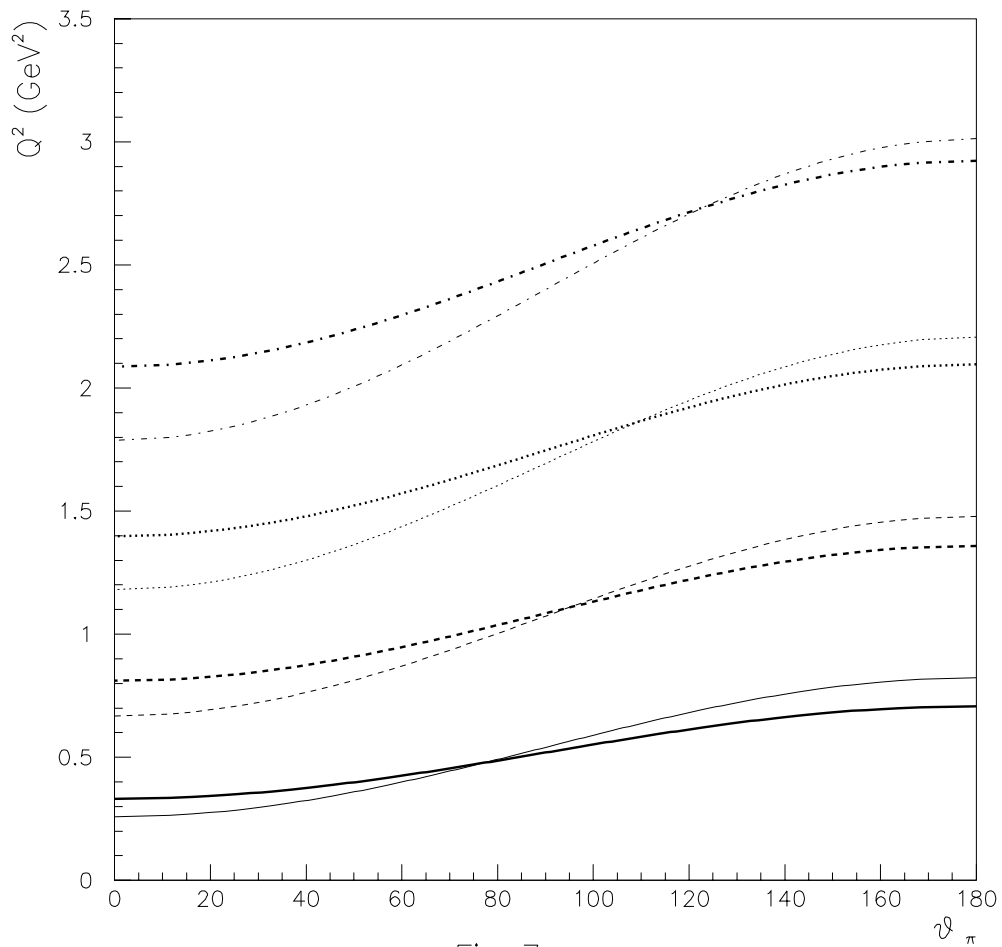

Fig. 7

FIG. 7. Dependence of the variable \vec{Q}^2 on ϑ_π . The thin (thick) lines correspond to $W = 1.2$ (1.137) GeV, $-k^2=0.5$ GeV² (full line) $-k^2=1$ GeV² (dashed line) $-k^2=1.5$ GeV² (dotted line) $-k^2=2$ GeV² (dashed-dotted line)

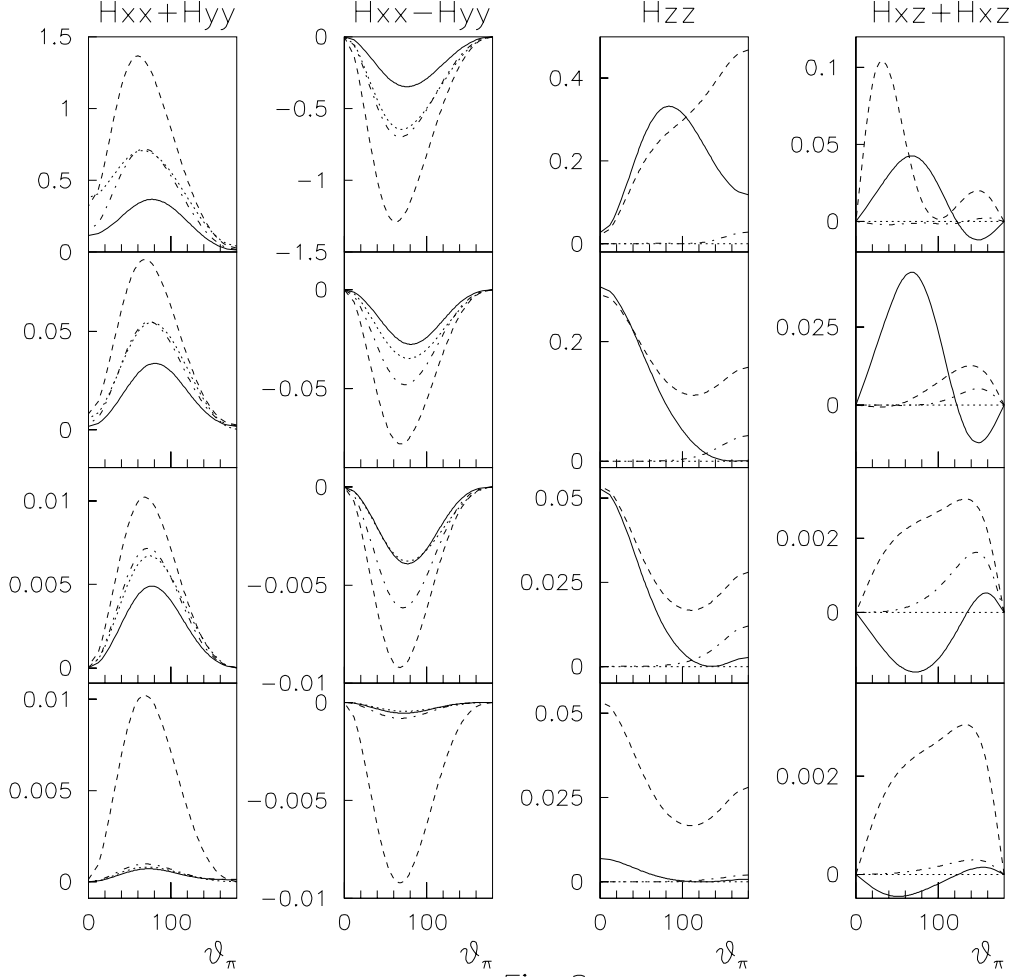

Fig. 8

FIG. 8. ϑ_π -dependence of the different contributions to the exclusive differential cross section for $d(e, e\pi^0)d$, $H_{xx} + H_{yy}$, $H_{xx} - H_{yy}$, H_{zz} and $H_{xz} + H_{zx}$ at $W=1.137$ GeV. The different rows correspond to $-k^2 = 0.5, 1, 1.5$ and 2 GeV², from top to bottom. Different mechanisms are shown: Δ -contribution only (dotted line), $\Delta + s + u$ contributions (dashed-dotted line), $\Delta + s + u - \omega$ (dashed line) $\Delta + s + u + \omega$ (full line).

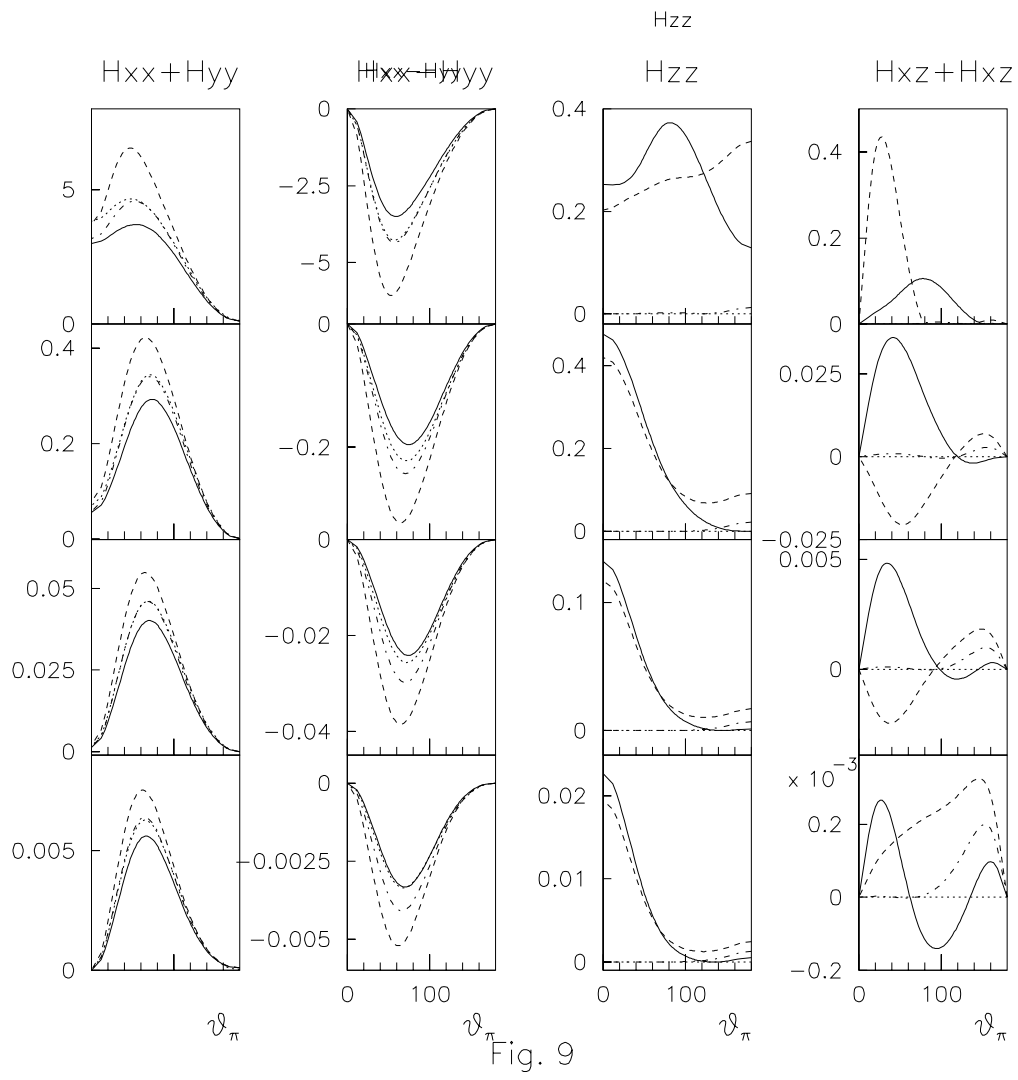

FIG. 9. Same as Fig. 8, but for $W = 1.2$ GeV.

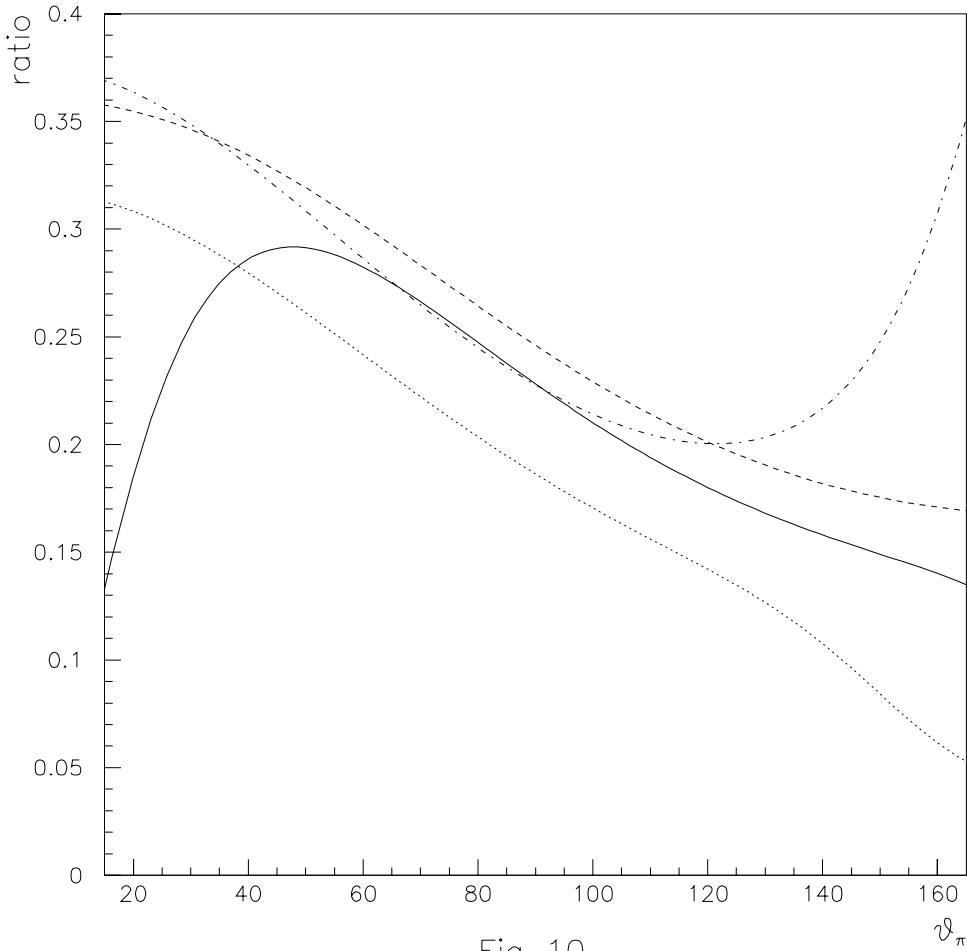

Fig. 10

FIG. 10. ϑ_π -dependence of the ratio $r_\pm(\cos \theta_\pi)$ for $W = 1.137$ GeV, with dipole G_{Ep} , and Paris wave function. The r_+ contribution is reported for $-k^2=0.5$ GeV² (full line) and for $-k^2=2$ GeV² (dotted line). The r_- contribution is reported for $-k^2=0.5$ GeV² (dashed line) and for $-k^2=2$ GeV² (dashed-dotted line).

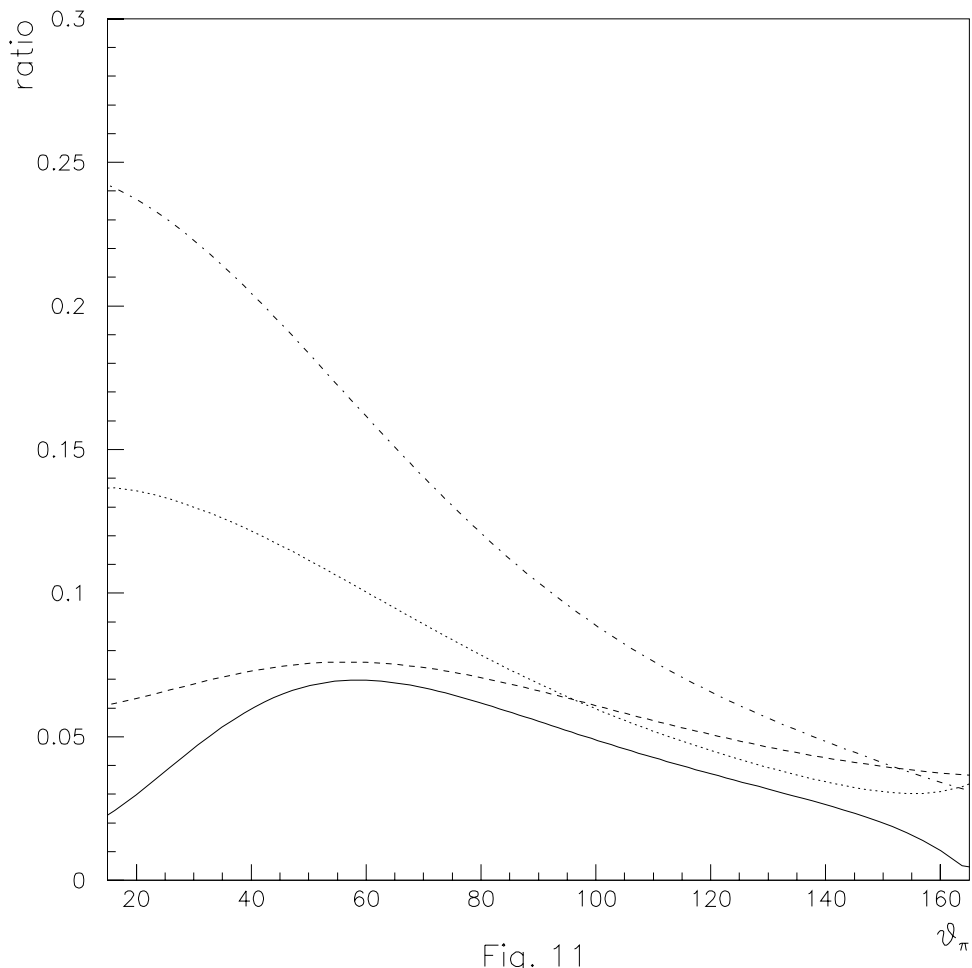

Fig. 11

FIG. 11. Same as Fig. 11, but for $W = 1.2$ GeV.

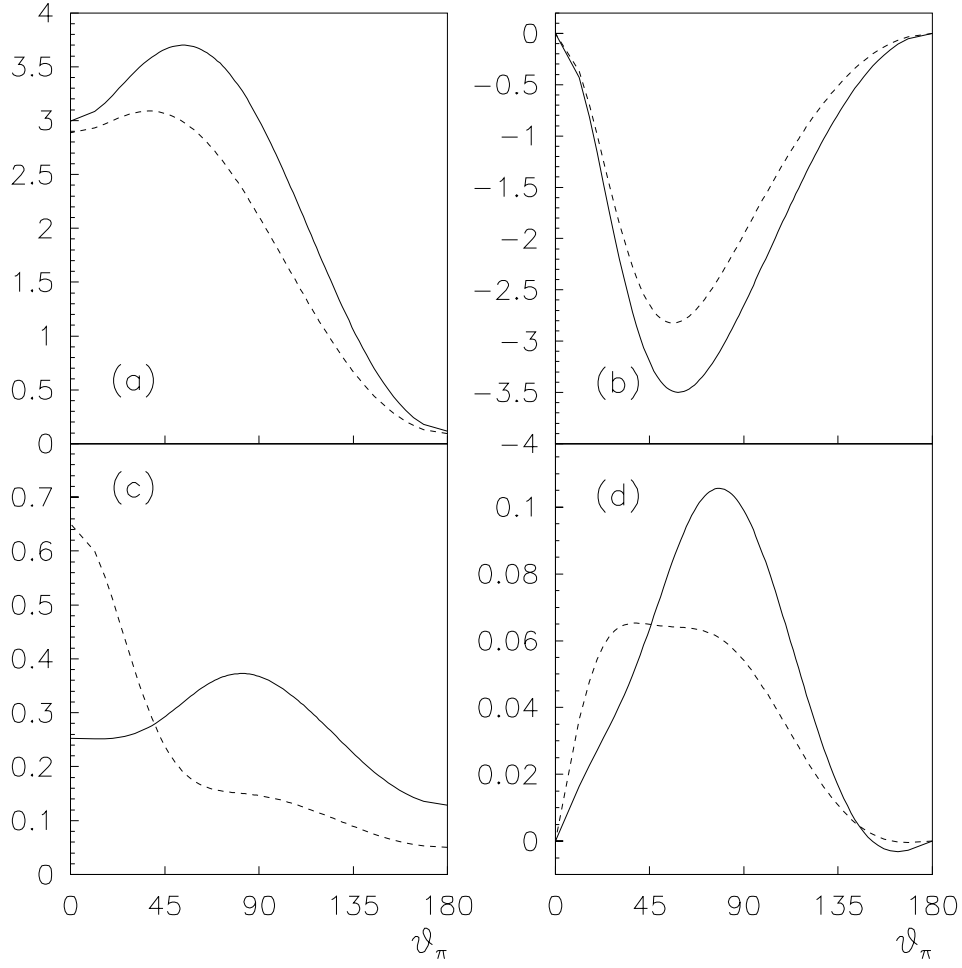

Fig. 12

FIG. 12. Sensitivity of the four observables: $H_{xx} + H_{yy}$ (a), $H_{xx} - H_{yy}$ (b), H_{zz} (c), $H_{xz} + H_{zx}$ (d), to the deuteron wave function, for Paris (full line) and Bonn(dashed line) potentials.

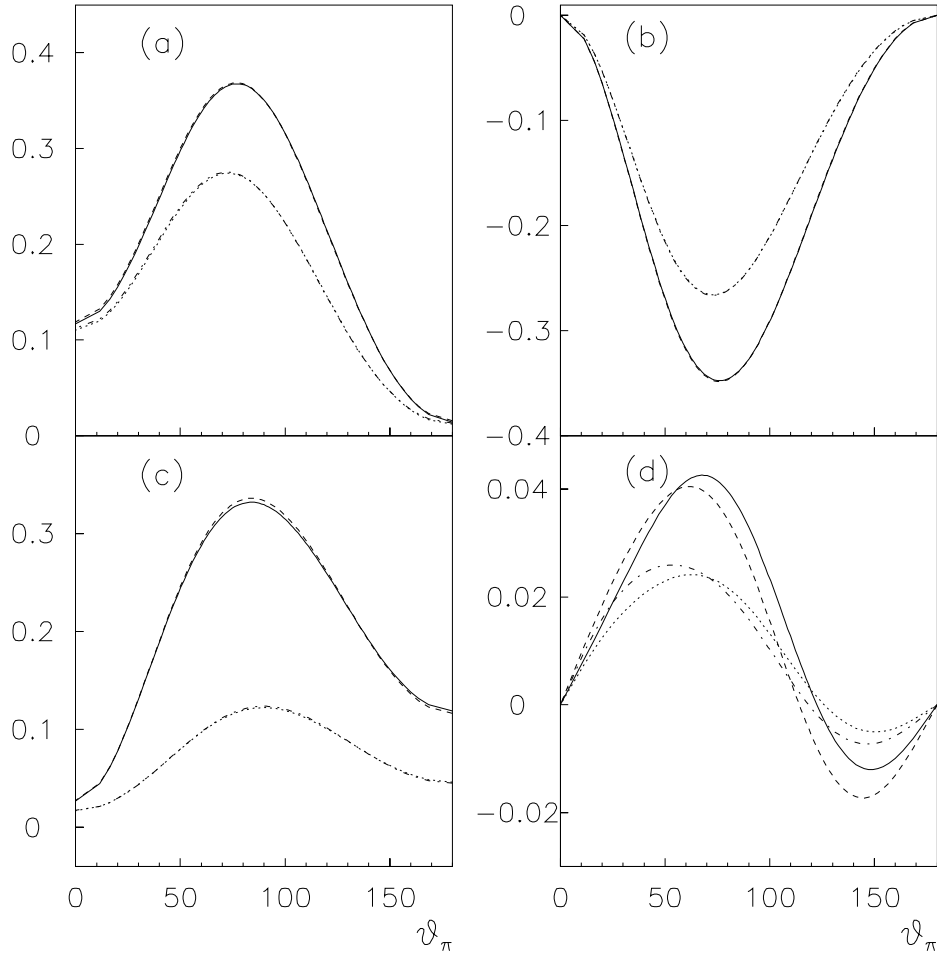

Fig. 13

FIG. 13. ϑ_π dependence of the four observables: $H_{xx} + H_{yy}$ (a), $H_{xx} - H_{yy}$ (b), H_{zz} (c), $H_{xz} + H_{zx}$ (d), for different parametrizations of the electromagnetic form factor of the $\gamma^*\pi\omega$ -vertex and electric form factor of the proton at $W=1.137$ GeV, $-k^2=0.5$ GeV² and hard form factor G_ω : Paris potential and *soft* G_{Ep} (full line), Paris potential and *dipole* G_{Ep} (line), Bonn Potential and *dipole* G_{Ep} (dotted line), Bonn Potential and *soft* G_{Ep} (dashed-dotted line).

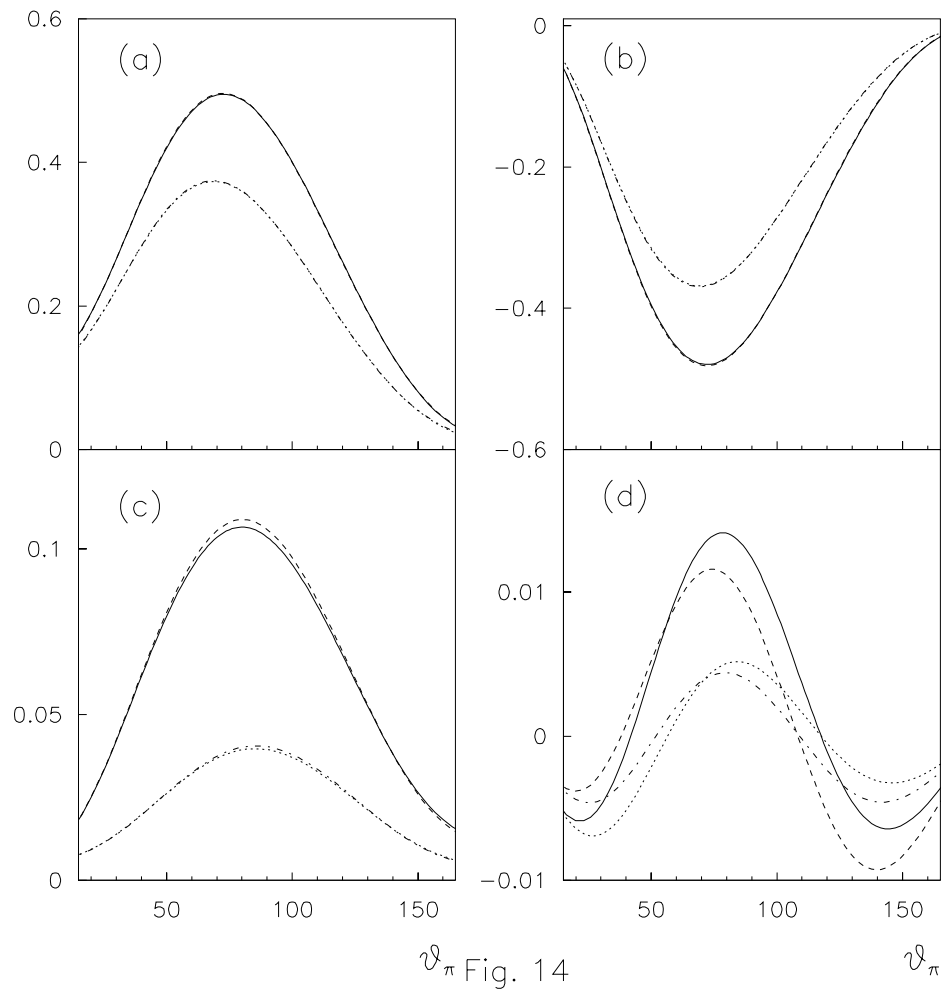

FIG. 14. Same as Fig. 13, but for soft form factor G_ω .

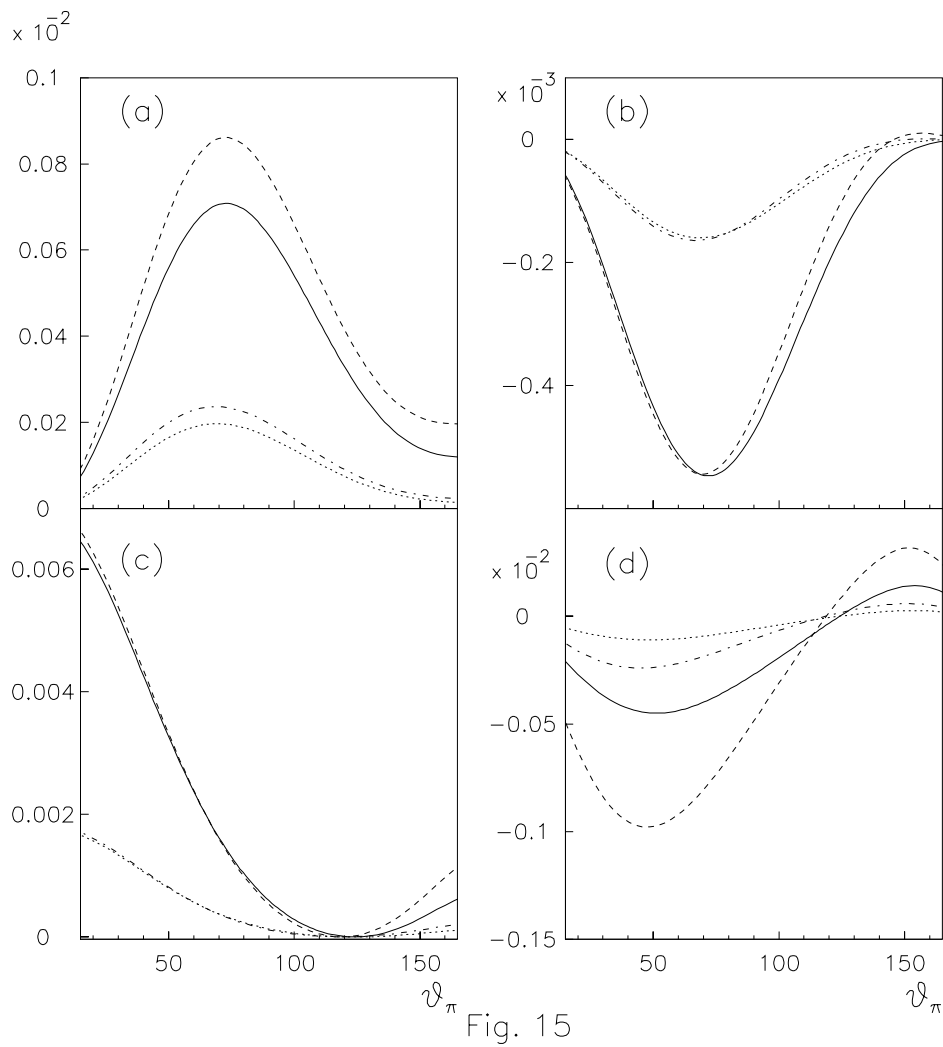

Fig. 15

FIG. 15. Same as Fig. 13, but for $-k^2=2.0 \text{ GeV}^2$ and hard form factor G_ω .

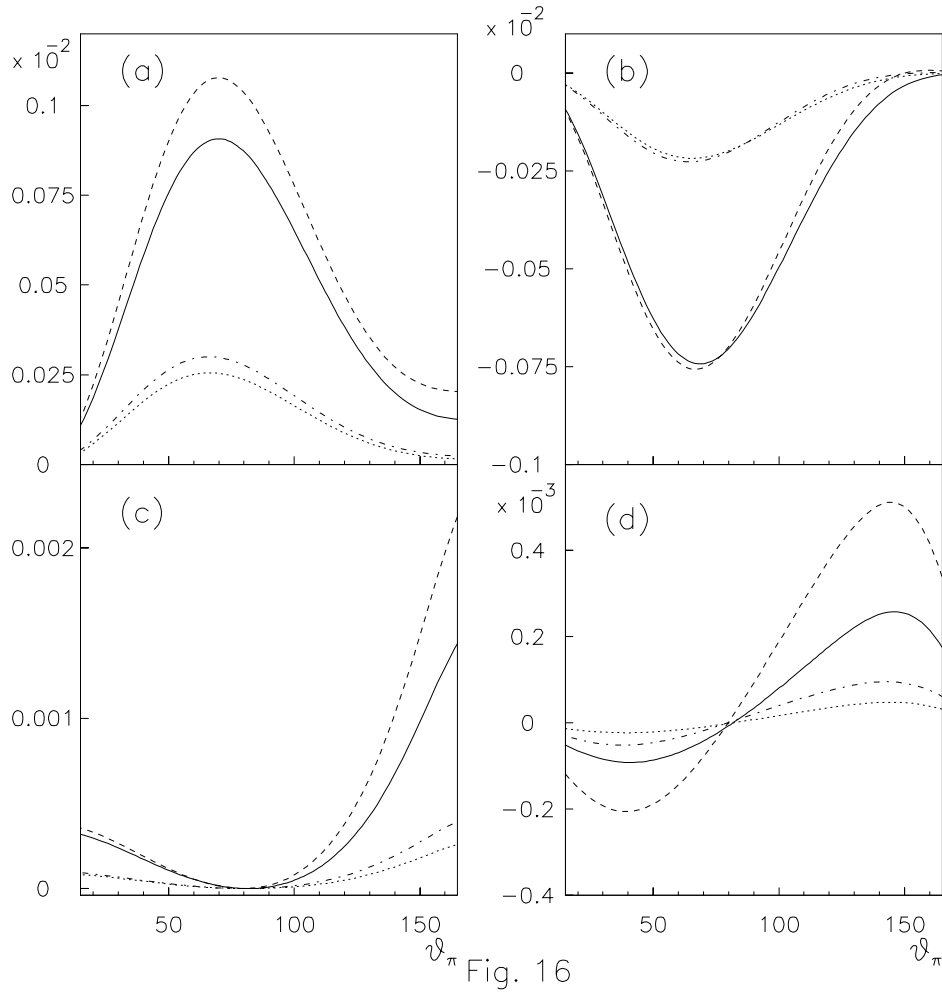

FIG. 16. Same as Fig. 13, but for $-k^2=2.0 \text{ GeV}^2$ and soft form factor G_ω .

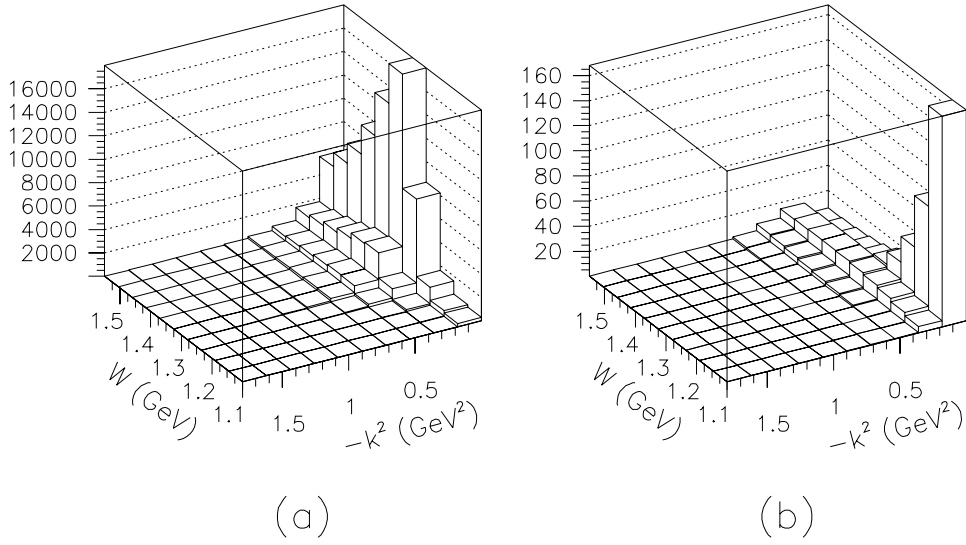

Fig. 17

FIG. 17. Two-dimensional plot of the $-k^2$ and W -dependences of the transversal H_t (a) and longitudinal H_l (b) contributions to the inclusive differential cross section for $d(e, e')\pi^0 d$ (H_l and H_t are dimensionless numbers).

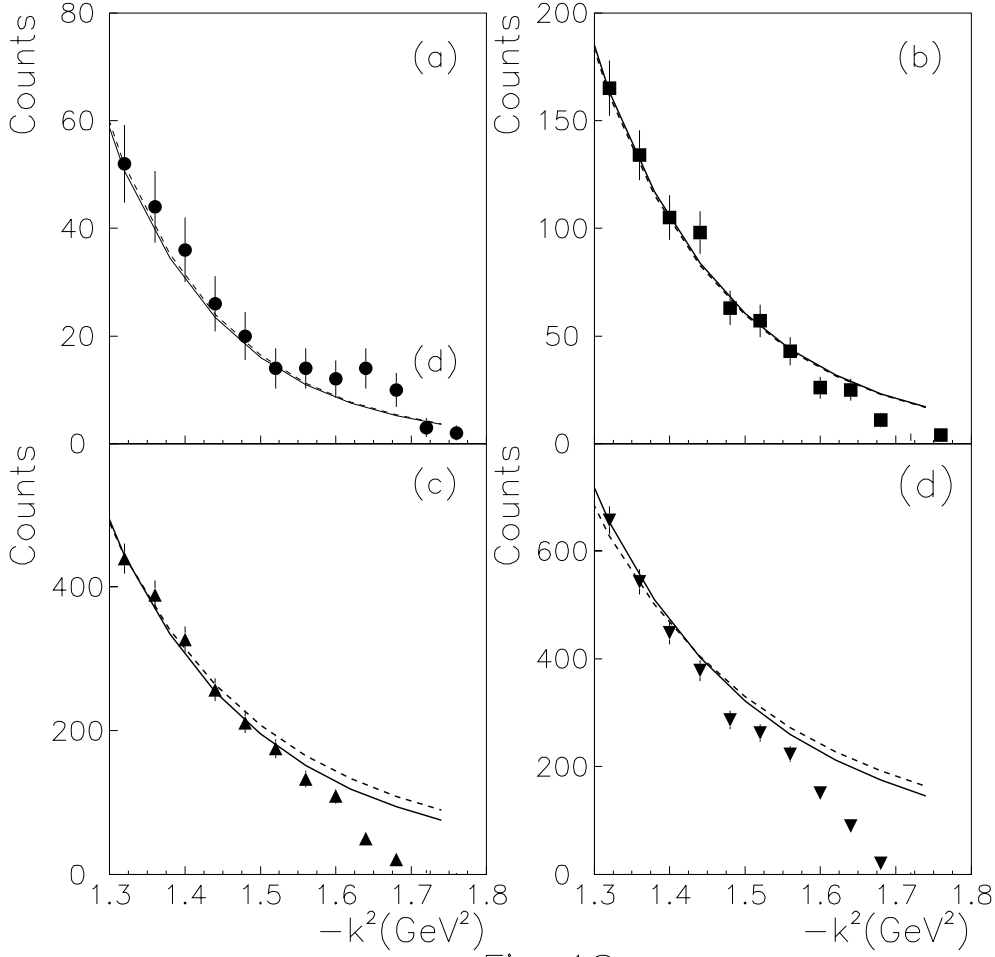

Fig. 18

FIG. 18. Comparison between the theoretical predictions and the data, for the k^2 -dependence of the cross section and different bins of the invariant mass $\Delta W = W - W_{thr}$: $0 \leq \Delta W \leq 40$ MeV (a); $40 \text{ MeV} \leq \Delta W \leq 80$ MeV (b); $80 \text{ MeV} \leq \Delta W \leq 120$ MeV (c); $120 \text{ MeV} \leq \Delta W \leq 160$ MeV (d). The solid line and dashed lines correspond to different ranges of ϕ -integration, 2π and $\pm\pi/6$, respectively. The points are taken from [3]. The curves are normalized to the highest point.

TABLES

	d	\vec{d}	$\vec{\vec{d}}$	sum
e	4(+)	8(-)	16(+)	28
\vec{e}	1(-)	5(+)	7(-)	13
sum	5	13	23	41

TABLE I. Classification of Structure Functions. The sign \pm denotes T-even and T-odd SF's