

RBS AND NRS ANALYSIS OF SPUTTERED NB FILMS ANNEALED AT DIFFERENT TEMPERATURES

M.RIBEAUDEAU, P.BOSLAND
Service d'Etude des Accélérateurs,
CEA/SACLAY,
F-91 191 Gif-sur-Yvette

A.CHEVARIER, O.GUISE, P.TROUVE
Institut de Physique Nucléaire de Lyon,
IN2P3-CNRS et Université Claude Bernard
43 Bd du 11 Novembre 1918,
F-69 622 Villeurbanne Cedex

ABSTRACT

The substrate temperature during niobium sputtering may play an important role on the quality of the thin film deposited inside a copper cavity. At high temperature, an improvement of thin film's structure can be expected due to the enhancement of surface diffusion during the growth. Nevertheless, we have to determine the maximal temperature without significant diffusion of the copper substrate into the niobium film.

Niobium films are elaborated on substrates kept at 323K or 673K. After the sputtering, unheated samples are annealed at temperatures ranging from 673K to 1073K. Copper and Niobium concentration profiles are obtained by Rutherford Backscattering Spectroscopy. No copper diffusion is detected in the bulk of the niobium film up to 1073K. We also measure oxygen and carbon concentration by Nuclear Reaction Spectroscopy and observe niobium films surface morphology with an Atomic Force Microscopy.

1. INTRODUCTION

At 1,6 K, the main characteristic of 1,5 Ghz Nb/Cu cavities sputtered at Saclay is the increase of their residual surface resistance with rf magnetic field level. In order to reduce this limitation, we explore new preparation procedures. This paper focuses on the influence of the substrate temperature during sputtering on niobium thin films. According Thornton's diagram [1], sputtered films morphology depends on two parameters: the argon pressure and the ratio between the substrate's temperature and the melting temperature T_m of the coated material. ($T_{mNb} = 2741$ K). For temperatures lower than $0.2T_m$ ($T < 550$ K) niobium films present crystallographic defects, such as dislocation networks of high density, due to the lack of atoms mobility during the growth. Increasing the temperature up to $0,3T_m$ (about 820 K) enhances the surface diffusion of the depositing atoms. This may generate a « better » crystallographic structure and perhaps larger grain sizes. However, this improvement on the thin film's structure may be ineffective if a copper diffusion or any other impurities occurs in the niobium film.

The bibliography on Nb/Cu diffusion presents contradictory experimental results. On the one hand, M.Yoshitake [2] studies samples annealed at different temperatures after a RF sputtering at ambient temperature. Using Auger Spectrometry while heating, he shows that Cu did not appear on the surface of the niobium film heated up to 1100 K for several hours. On the other hand, M Okuda [3] highlights the copper diffusion into niobium films since 673 K. His conclusions deduced from Auger spectra concern samples deposited on heated substrates with bias voltage applied. At these temperatures, the diffusion of copper atoms occurs through grain boundaries and may be more or less enhanced depending on the characteristics of the films. This paper presents the experimental results obtained on heat treated samples prepared on our sputtering apparatus developed for 1,5 Ghz Nb/Cu cavities. Nb and Cu concentration profiles are determined using RBS method. Pollution due to oxygen or carbon diffusion is also studied by NRS.

2. EXPERIMENTAL

2-1 Sample preparation

OFE copper and silica sheets of 99,9% purity are cut into 25mm×8mm×1mm pieces. Silica substrates are mirror polished, degreased in heated alkaline bath with ultrasonic waves then rinsed with high purity water and dried with filtered air flow. Copper substrates, after being degreased, are electropolished in diluted acid solution (H_3PO_4 and H_2O) during 2 hours at ambient temperature and rinsed with high purity water and dried with filtered air flow.

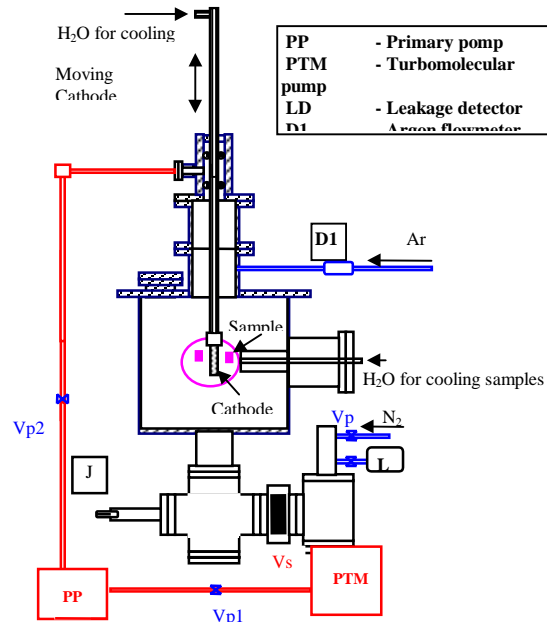

Figure n°1 :schematic view of the sputtering set-up

Niobium films are deposited by dc cathodic magnetron sputtering on silica or copper substrates. Silica substrates are used to study the evolution of RRR and critical temperature after heat treatment. High purity niobium ($RRR \geq 200$) is sputtered using an argon pressure of $3,5 \cdot 10^{-3}$ mb for 10 mn; the magnetron intensity is maintained at about 1,5 A for a delivered power of 600 W. During pumping before sputtering, the vacuum chamber is baked out at 440K. Then the substrate's temperatures are kept at 323 K, using

pressurized water flow, or at 673K (figure n°1) during sputtering. The deposition rate and the typical thickness of niobium films are respectively about 1 nm/s and 500 nm.

2-2 Heat treatments

After the sputtering, unheated samples are annealed in vacuum for one hour (which corresponds to the coating time of a cavity). They are placed in a clean titanium box to be protected from the impurity gases desorption. Before annealing, the quartz chamber of the furnace is baked out at 473 K. Then, the temperature is raised progressively in order to keep the pressure below $5 \cdot 10^{-7}$ mb, till the annealing temperature of 673 K, 873 K or 1073 K. Ten samples were treated for the experiment as summarized in table 1.

SAMPLE	N°	SPUTTERING T(K)	ANNEALING T (K)
Nb/Cu	B	323	no
Nb/Cu	C	323	673
Nb/Cu	D	323	873
Nb/Cu	E	323	1073
Nb/Cu	F	673	no
Nb/SiO ₂	6	323	no
Nb/SiO ₂	7	323	673
Nb/SiO ₂	8	323	873
Nb/SiO ₂	9	323	1073
Nb/SiO ₂	10	673	no

Table n°1 : sample temperatures of sputtering and annealing

2-3 Investigation methods

Nb and Cu concentration profiles after heat treatments are determined by Rutherford Backscattering Spectroscopy with ⁴He species of 3 MeV. Oxygen and carbon concentrations are obtained by Nuclear Reaction Spectroscopy using ⁴He species of 7,5 MeV. In both cases, the bombarded area is 1mm². Analysis take place at ambient temperature in a 10^{-7} mbar vacuum. All the spectra are obtained with 300 000 counts ($\sim 10^{14}$ particles detected) and the resolution depth is 10 nm. The global detection limit, estimated at 1%0 atomic, is an important parameter for the interpretation of the results (section 4)

The gaussian spectra are gauged using different particles energies. The interpretation of the experimental spectra is carried out by comparing data with theoretical curves. The sample is fictively decomposed on several elementary thin films. Within each section, we consider the stopping power as a constant. The energy detected depends both on the nature of the element and its depth in the film.

3. RESULTS

3-1 RBS analysis

This first part of the study aims to determine the copper and niobium concentration profiles using Rutherford Backscattering Spectroscopy. Figure 2 displays the global spectrum obtained with the reference sample B which has not been heat treated. Between channel 650 and 750 we can see that the niobium signal falls vertically till the « zero » count whereas the copper signal has an abrupt rise starting from zero. No copper diffusion is detected into the bulk niobium but only a 80 nm niobium copper interdiffusion at the interface. Channel 845, the niobium peak has a rounded shape revealing a surface contamination. A small oxygen peak is detected on channel 354 which corresponds to a surfacial oxide layer.

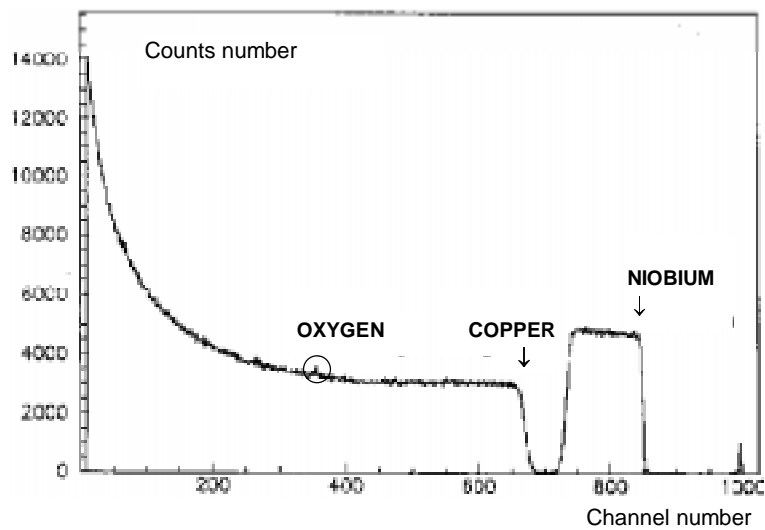

figure n°2 : RBS spectrum of unheated sample B

Sample C and F respectively annealed or elaborated at 673K (figure n°3) present spectra very similar to the reference one. With an annealing temperature of 873K, such as sample D, a slight increase of niobium and copper interdiffusion appears. On the spectrum of sample E annealed at 1073K (figure n°4) we can notice that the niobium signal doesn't reach the base line. Nevertheless, there's still no copper detected on the niobium surface. We report on graph n° 1 the calculated interdiffusion depths which is defined as the zone where both copper and niobium are detected.

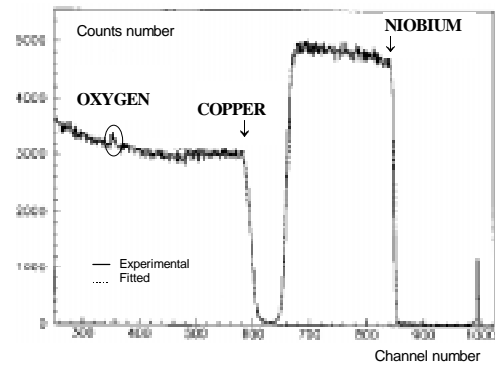
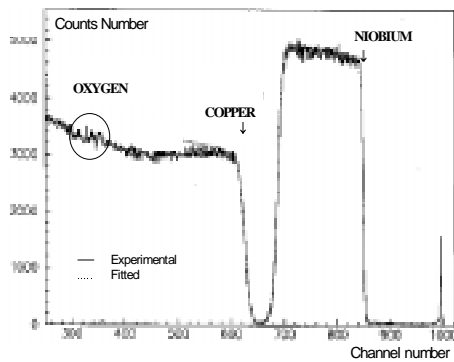

figure n°3 : RBS spectra of sample C annealed at 673K (left) and sample F sputtered at 673K (right)

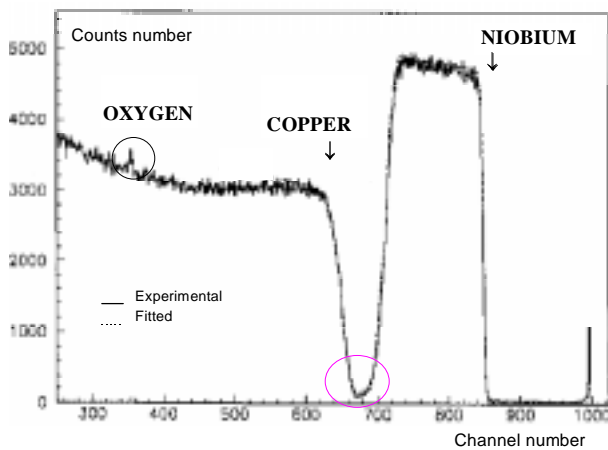
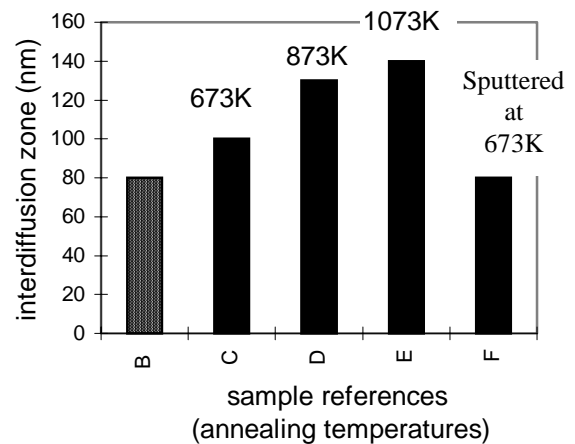

Figure n°4 : RBS spectrum of sample E annealed at 1073 K



Graph n°1 : simulation results on Nb/Cu diffusion

3-2 NRS measurements

Oxygen and carbon concentrations are determined by Nuclear Reaction Spectroscopy. Figure n°6 shows the reference sample B spectrum. We notice two peaks of different heights. The lowest peak located channel 300 highlights the existence of interfacial oxygen attributed to adsorbed residual gases trapped under the coating. The highest peak on channel 354 corresponds to the surficial oxygen due to air exposure. This two peaks are very narrow and we observe that the bulk niobium contains less oxygen than the detection limit. At the opposite, all annealed samples (figures n°5 and 6) contain more than 0.5% of oxygen in the bulk of the film. At the annealing temperature of 1073 K (figure n°6), the oxygen interfacial peak disappears by diffusion mechanism. As shown on figure n°7, the sample sputtered at 673 K is free from significant oxygen contamination. Furthermore, no interfacial oxygen is detected : the baking of the vacuum chamber at 673

K before deposition may have removed the major part of adsorbed gas from the copper substrate surface.

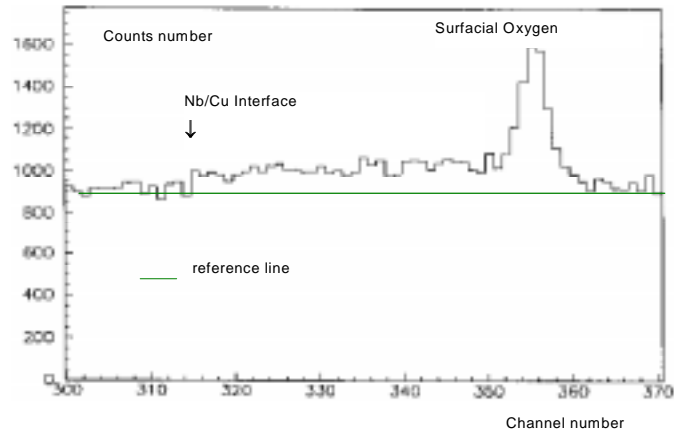
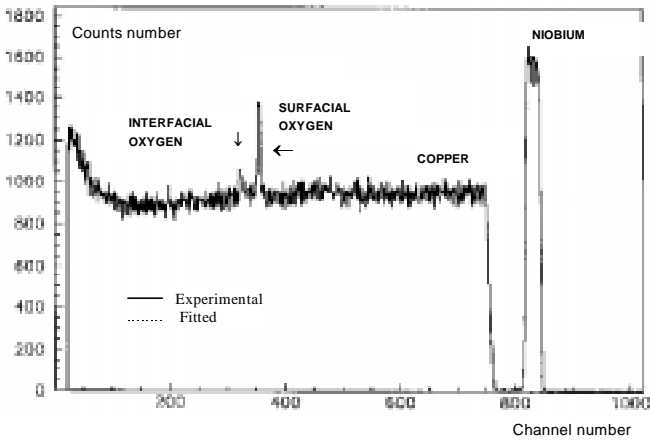

figures n°5 and n°6 :
NRS spectra of unheated sample 1 (left) and sample 5 annealed at 1073 K (right)

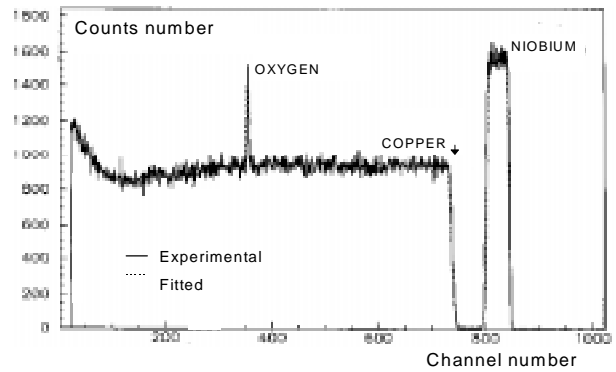
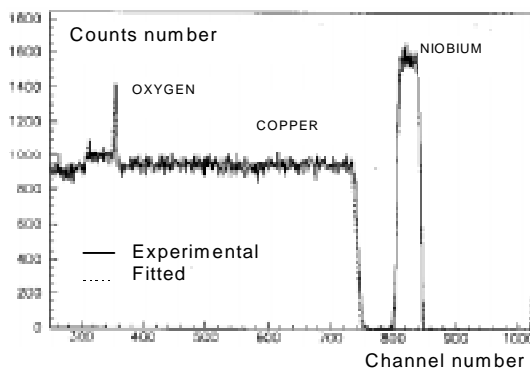

figures n°7 and n°8 :
NRS spectrum of sample C annealed at 673 K and sample F sputtered at 673 K

3-3 RRR and critical temperature

We measured the critical temperature T_c and the RRR of the niobium films deposited on silica substrates (table n°3). As expected, the oxygen diffusion in niobium leads to a degradation of these parameters. We also observe that sample sputtered at 673 K has a better RRR value than samples elaborated at 323 K.

The RRR values of these 500 nm in thickness films are much lower than for films deposited in the accelerating cavities (about 20) which are thicker than 2 μm . The RRR value is very sensitive to the thickness of the film.

sample	Tc (K)	Tc (K)	RRR	RRR	annealing T (K)
	before annealing	after annealing	before annealing	after annealing	
7	9,2	9	4	4	673
8	9,2	8,7	4.3	3,8	873
9	-	7,3	-	2.3	1073
10	9,3	×	11	×	no

table n°3 : RRR and Tc measurements of samples deposited on SiO₂ substrates

3-4 AFM images

Figure 9 represents the surface image of the Nb/Cu sample F obtained by Atomic Force Microscopy. Niobium films are characterised by elongated and columnar grains growing approximately perpendicularly to the substrate surface. This fibber morphology is commonly observed for sputtered Nb films [4]. The grain size can be estimated from the nano-roughness profile. The coating has been sputtered at 673K and this process induces a high density of grain boundaries due to the small size grains.

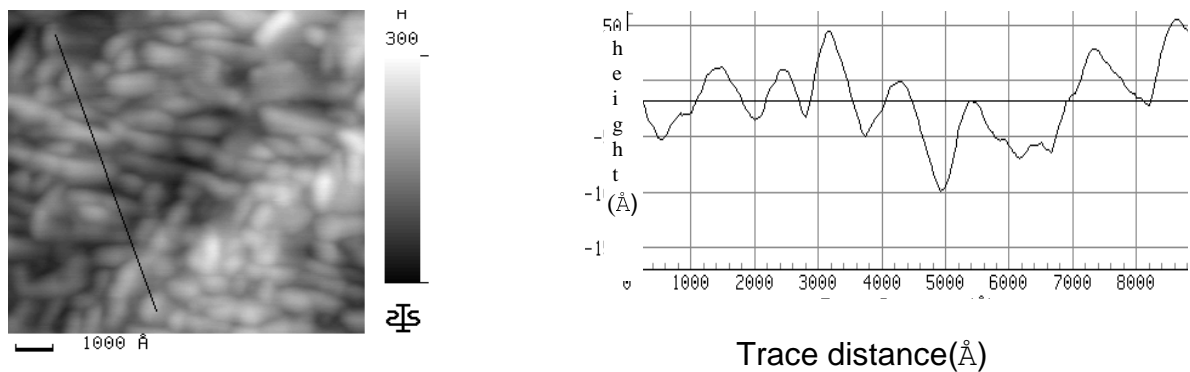

figure n°9 : AFM image and height profile of sample F

It seems that the average grain size increases when the annealing temperature reaches 1073K (figure n°10).

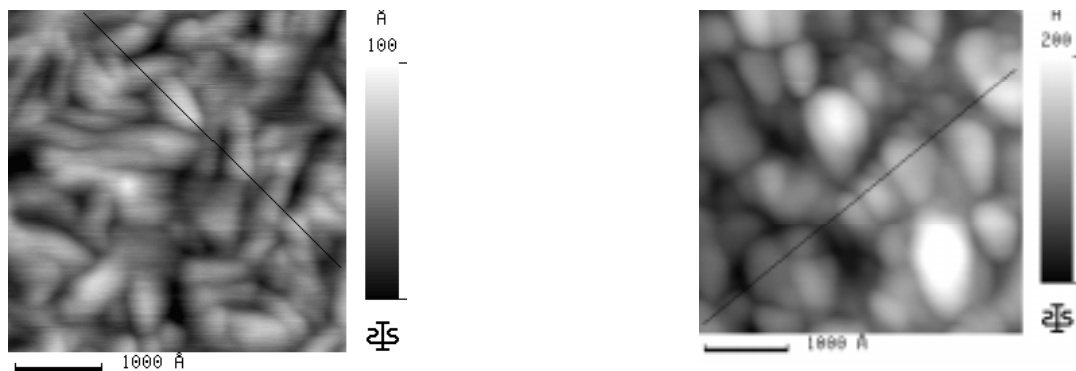

figure n°10 : AFM images of unheated sample (left) and sample annealed at 1073K (right)

4. DISCUSSION

Different diffusion processes can occur in polycrystalline solids, depending on the temperature. At low temperature, far from T_m , only the surface diffusion is activated. It is characterised by a diffusion coefficient D_s , expressed in $\text{cm}^2 \cdot \text{s}^{-1}$, and obeying the well known Arrhenius law :

$$D_s = D_{s0} \cdot \exp(-Q_s/RT)$$

D_{s0} is the frequency factor and Q_s the activation energy (cal/mole).

For temperatures ranging between $0.3T_m$ and $0.5T_m$, a second phenomenon appears : grain boundary diffusion with its Arrhenius law coefficients D_b , D_{b0} , and Q_b .

For higher temperature ($0.7T_m$ to T_m), volume diffusion in the crystallites is enhanced by the exponential increase of the defects number. This mechanism is also described by the Arrhenius law coefficients D_v , D_{v0} , and Q_v .

These three temperature scales are not strictly separated and at intermediate temperatures the different mechanisms can coexist. Our goal is to determine the existence of a temperature range in which niobium surface self diffusion is enhanced, while keeping negligible the grain boundary diffusion of the copper and the other impurities, compared to the deposition speed.

At temperatures below $0.6T_m$ the diffusion mechanism is governed by grain boundary diffusion [5]. Therefore between 673 K and 1073 K (corresponding to $0.24T_m$ and $0.39T_m$ respectively for niobium) we can consider in a first approximation grain boundaries as short-circuiting paths for impurities diffusion, dominating the atomic traffic. Figure n°11 displays the concentration profiles in that case : the extent of lateral volume diffusion is very limited and the influence of direct volume diffusion is negligible.

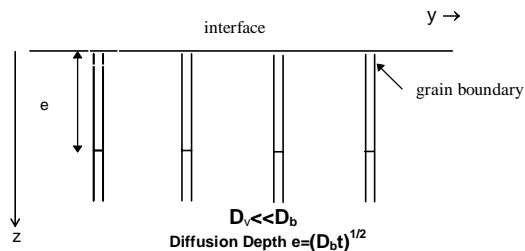

fig n°11 : Schematic Illustration of one type of Diffusion Kinetic (with a model of polycrystal with uniformly spaced grain boundaries)

These remarks focus the fact that in our samples, if copper diffusion occurs, the copper atoms are concentrated in the grain boundaries. Copper can reach high concentration values in these small volumes without being detected by RBS, which is therefore a very sensitive method.

A rough analysis can give the magnitude order of the detection limit in these grain boundaries. The observed geometry of the crystallites is described in paragraph 3.4, and we basically modelled the Nb surface analysed by RBS niobium as a diamond pattern of grains 30 nm width and 100 nm long separated by grain boundaries 0.5 nm width. This given thickness of grain boundary is generally taken as a realistic one [6]. Assuming that the niobium grains are columns which height is the thickness of the film, the ratio of the grain boundary volume on the total analysed volume is the ratio of the corresponding cross section area namely about 2% for the geometry previously described. Taking into account the 1‰ detection limit of the global RBS method, this limit raised up to about 5% in the grain boundary volumes. This last value is of course very sensitive to the grain boundary width used for calculations, and in a second order to the geometry of the crystallites.

The last remark concerns the oxygen pollution of annealed samples. The oxygen atoms may diffuse along grain boundaries and their presence may reduce the diffusion of copper atoms. We haven't studied this phenomenon.

5.SUMMARY

Niobium films 500 nm in thickness were sputtered at room temperature on copper substrates. These samples were then annealed under vacuum at different temperatures up to 1073 K. Copper substrate diffusion through the niobium film was analysed using RBS. No significant diffusion was detected up to 1073 K. Furthermore, one other sample sputtered at a controlled temperature of 673 K also showed no copper diffusion in the Nb film. The RRR value of the film deposited onto silica substrate at 673 K was higher than for the ones deposited at room temperature.

The application of these experiments will be the preparation of 1,5 GHz Nb/Cu cavities at temperatures reaching 773°K during sputtering. The effect of the temperature during sputtering on the residual surface resistance will be analysed, with the hope of reducing the slope of the curve $Q_0=(E_{acc})$ generally observed on Nb/Cu cavities.

6.ACKNOWLEDGEMENTS

We are very grateful to Mr Chauvineau of Laboratoire de Physique des Couches Minces de l'Institut d'Optique to have realised AFM images.

7.REFERENCES

- [1] J.A.Thorton, Thin Solid Films, vol 64, p11, 1979.
- [2] M.Yoshitake ,Surface and Interface analysis, vol 18, p.509-513 (1992).
- [3] M Okuda, thesis.in japanese at The graduate University for Advances Studies, Kobe (1995)
- [4] K.L. Westra, Thin Solid Films, vol 257, p15-21, 1995.
- [5] I.Inderjeet, Fundamentals of Grain and Interphase boundary Diffusion, Wiley Ed.
- [6] G. Martin , B. Perrailon, La diffusion intergranulaire, Journal de Physique, C4 tome 36,p165-189, Oct.1975