



ForwArd **S**earch **Expe**Riment at the LHC

Jamie Boyd (CERN)

SACLAY Seminar

18/5/2020

Supported by:



HEISING-SIMONS
FOUNDATION

SIMONS
FOUNDATION

FASER website: <https://faser.web.cern.ch/>

FASER: THE IDEA

- New physics searches at the LHC focus on high p_T . This is appropriate for heavy, strongly interacting particles
 - $\sigma \sim \text{fb to pb} \rightarrow \text{In Run-3 } N \sim 10^2 - 10^5$, produced \sim isotropically
- However, if new particles are light and weakly interacting, this may be completely misguided. Instead can exploit
 - $\sigma_{\text{inel}} \sim 100 \text{ mb} \rightarrow \text{In Run-3 } N \sim 10^{16}$, $\theta \sim \Lambda_{\text{QCD}} / E \sim 250 \text{ MeV} / \text{TeV} \sim \text{mrad}$

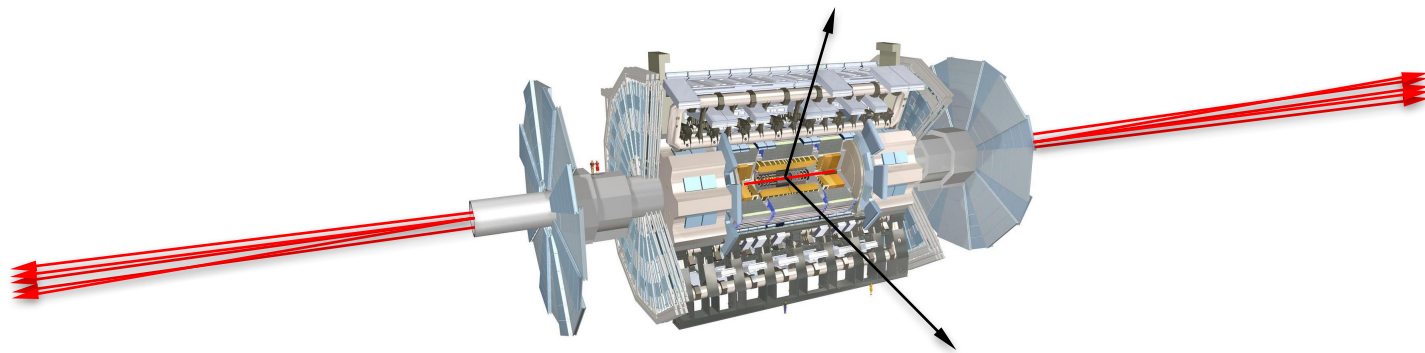

- FASER is a new experiment, to start running after LS2, designed to cover this scenario at the LHC
- Detector to be placed 480m from IP1 directly on the beam collision axis line of sight (LOS) with transverse radius of only 10cm covering the mrad regime ($\eta > 9.1$)

FASER LOCATION

- FASER will be situated along the beam *collision* axis line of sight (LOS)
 - ~480 m from IP
 - after beams start to bend
 - a few meters from the LHC beamline

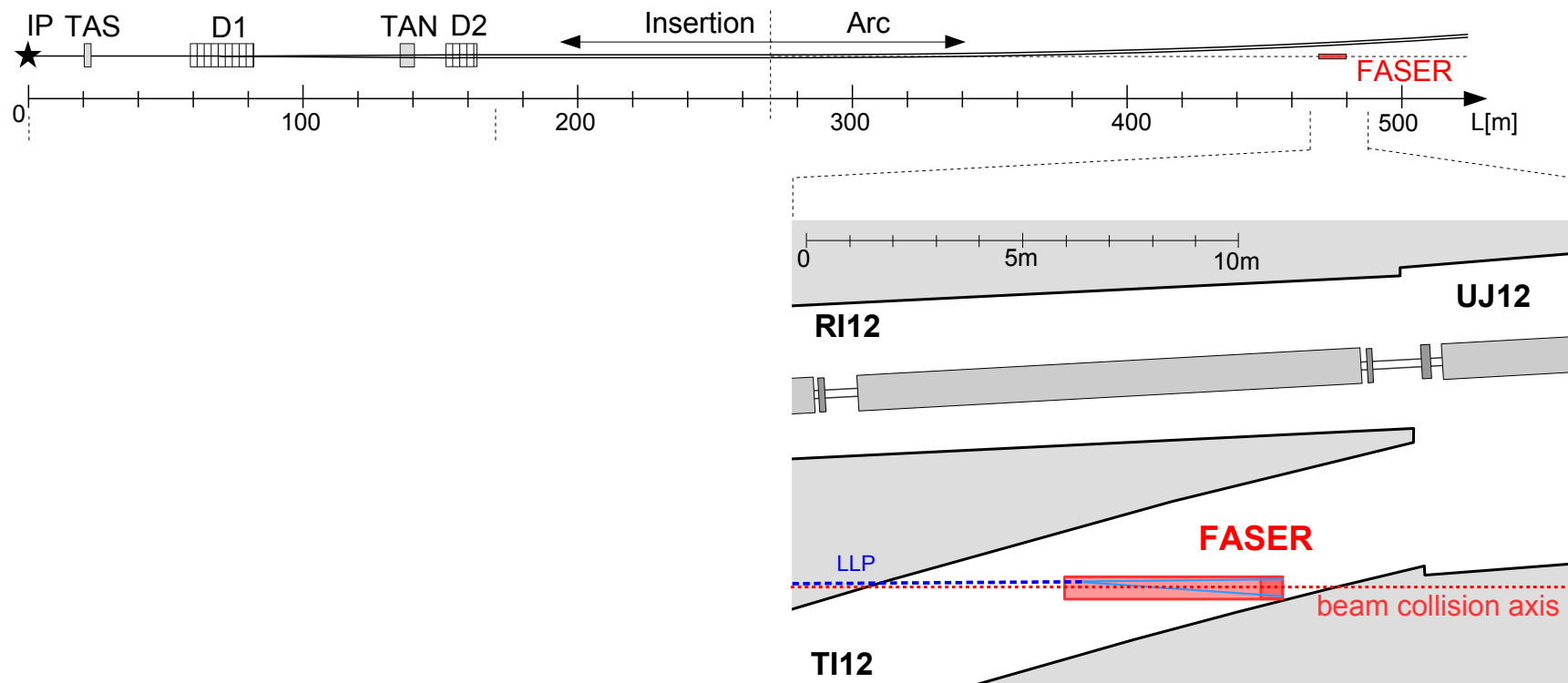

TI12 unused tunnel, that intersects LOS 480m from IP1

FASER LOCATION: TI12

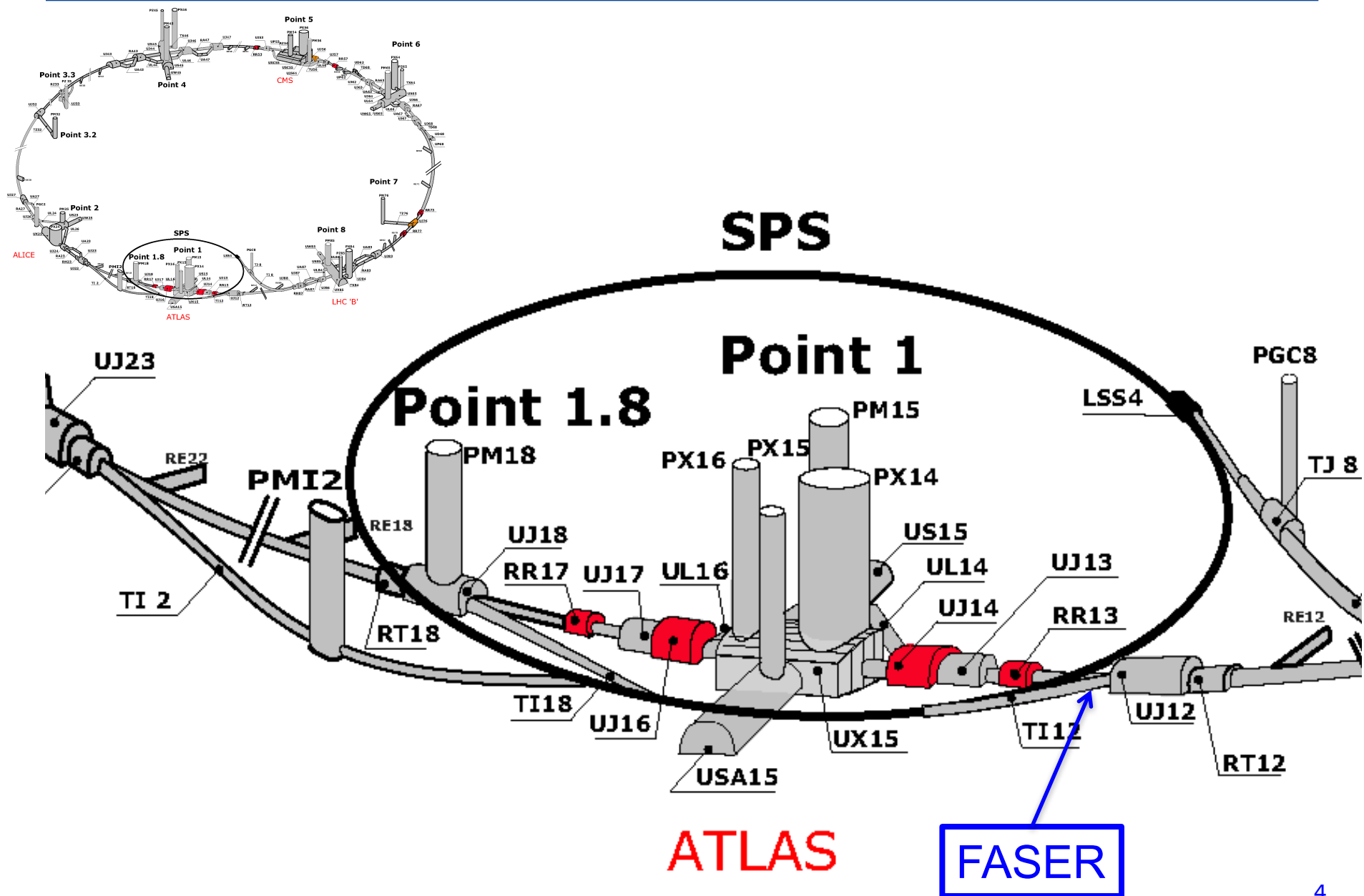

FASER LOCATION: TI12

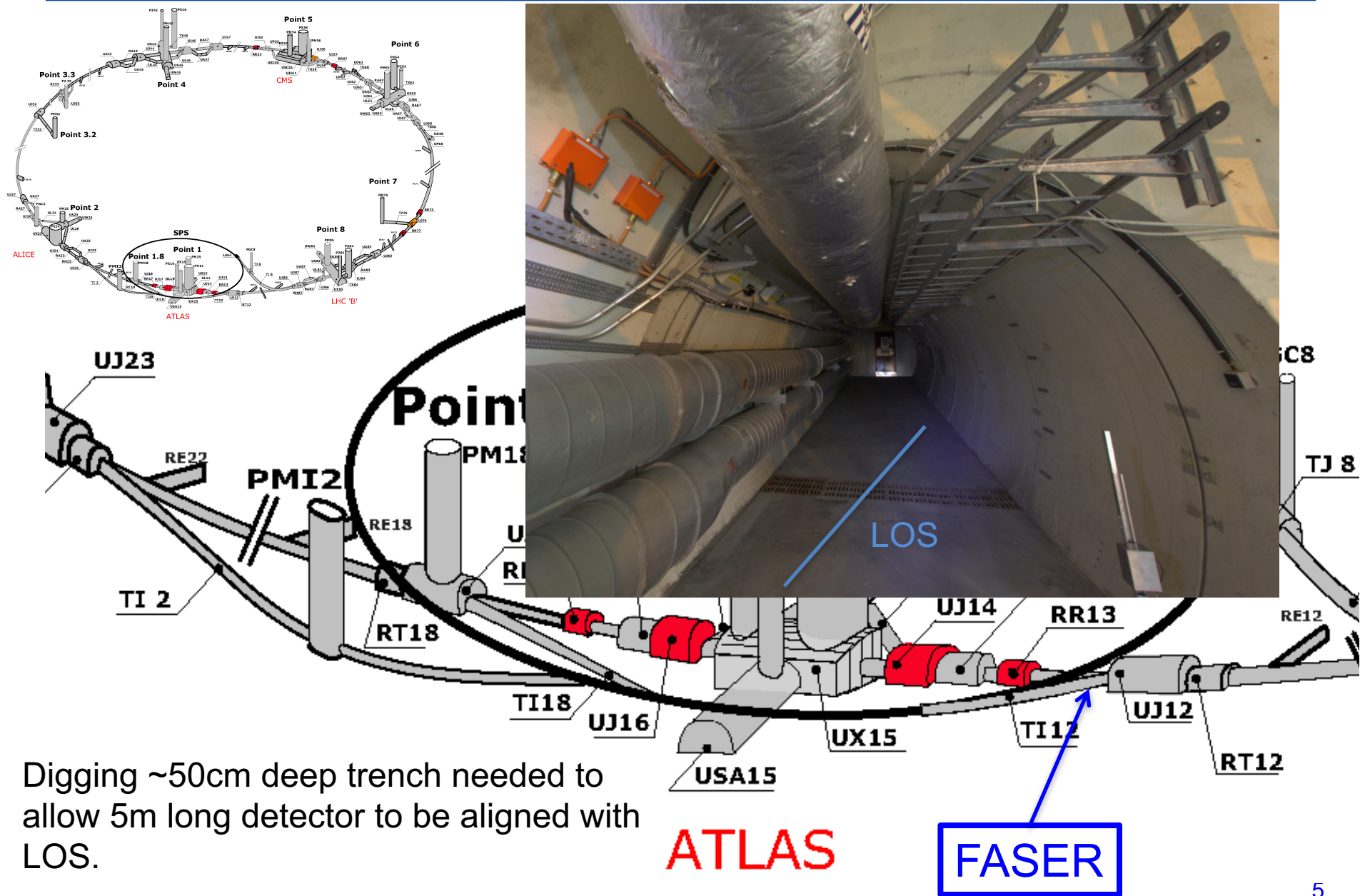

EXAMPLE PHYSICS CASE (DARK PHOTONS)

DARK PHOTONS

- Dark matter is our most solid evidence for new particles. In recent years, the idea of dark matter has been generalized to dark sectors
- Dark sectors motivate light, weakly coupled particles (WIMPlless miracle, SIMP miracle, small-scale structure, ..)
- A prominent example: vector portal, leading to dark photons

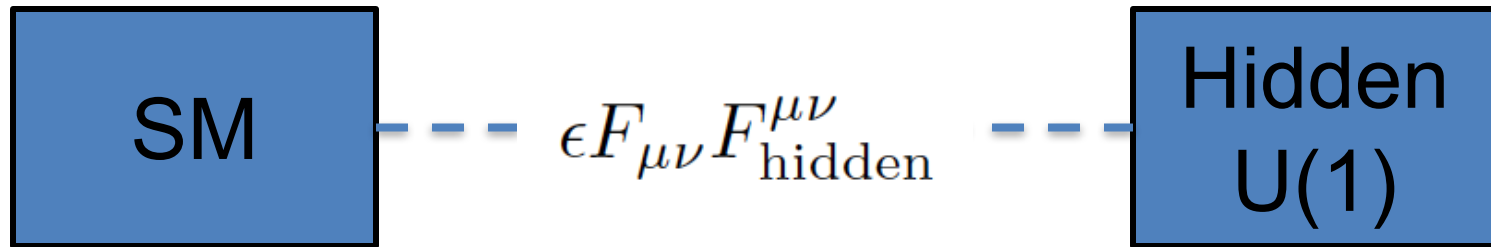

- The resulting theory contains a new gauge boson A' with mass $m_{A'}$ and ϵQ_f couplings to SM fermions f

DARK PHOTON PROPERTIES

- Produced (very rarely) in meson decays, e.g.,

$$B(\pi^0 \rightarrow A' \gamma) = 2\epsilon^2 \left(1 - \frac{m_{A'}^2}{m_{\pi^0}^2}\right)^3 B(\pi^0 \rightarrow \gamma\gamma),$$

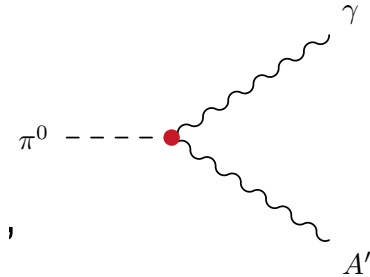

and also through other processes

- Travels long distances through matter without interacting, decays to e^+e^- , $\mu^+\mu^-$ for $m_{A'} > 2 m_\mu$, other charged pairs

$$\bar{d} = c \frac{1}{\Gamma_{A'}} \gamma_{A'} \beta_{A'} \approx (80 \text{ m}) B_e \left[\frac{10^{-5}}{\epsilon} \right]^2 \left[\frac{E_{A'}}{\text{TeV}} \right] \quad E_{A'} \gg m_{A'} \gg m_e$$

- TeV energies at the LHC \rightarrow huge boost, decay lengths of ~ 100 m are possible for viable and interesting parameters

PRODUCTION AT LHC

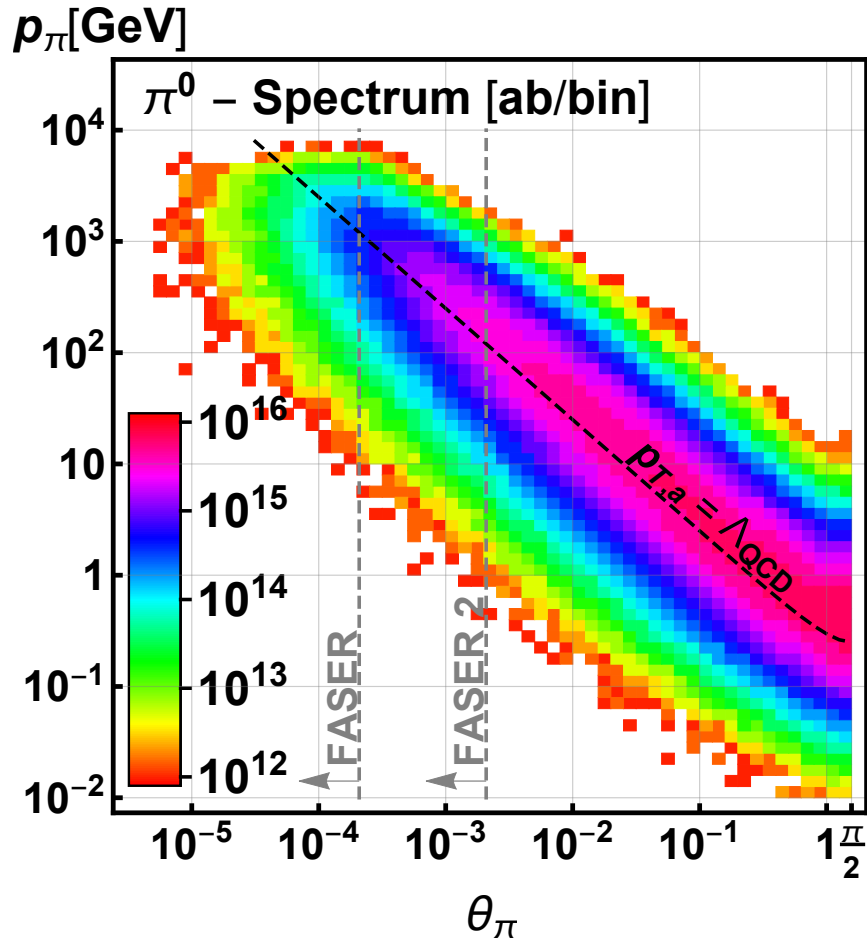

FASER takes advantage of the the huge number of light mesons (π^0, η, \dots) that are produced at the LHC, predominantly in the very forward direction.

For example for $E(\pi^0) \geq 10$ GeV,

- 2% of π^0 s fall in FASER acceptance;
- whereas the FASER acceptance covers just $(2 \times 10^{-6})\%$ of the solid angle.

PRODUCTION AT LHC

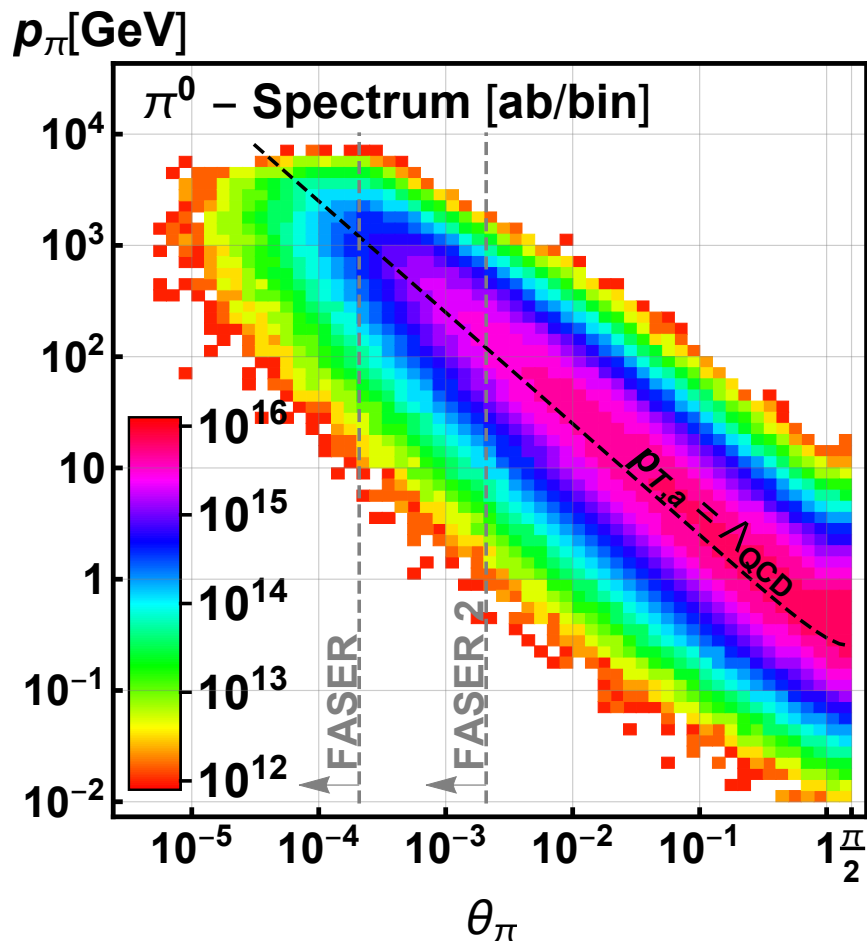

FASER takes advantage of the the huge number of light mesons (π^0, η, \dots) that are produced at the LHC, predominantly in the very forward direction.

For example for $E(\pi^0) \geq 10$ GeV,

- 2% of π^0 s fall in FASER acceptance;
- whereas the FASER acceptance covers just $(2 \times 10^{-6})\%$ of the solid angle.

Run-3 (0.15/ab) will produce a huge number of π^0 s in FASER angular acceptance. Even with large suppression ($\varepsilon^2 \sim 10^{-8} - 10^{-10}$ for relevant region of parameter space) can still have very large number of dark photons produced.

LHC can be a dark photon factory!

DARK PHOTONS IN FASER

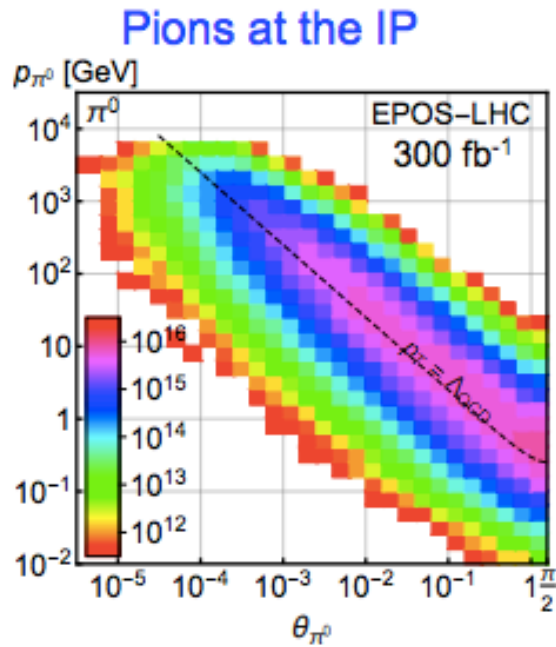

- Simulations greatly refined by LHC data
- Production is peaked at $p_T \sim \Lambda_{\text{QCD}} \sim 250 \text{ MeV}$
- Enormous event rates: $N_\pi \sim 10^{15}$ per bin

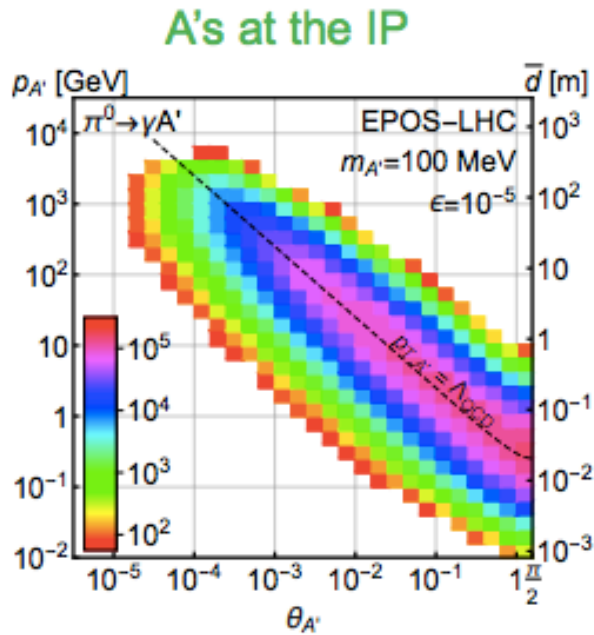

- Production is peaked at $p_T \sim \Lambda_{\text{QCD}} \sim 250 \text{ MeV}$
- Rates highly suppressed by $\epsilon^2 \sim 10^{-10}$
- But still $N_{A'} \sim 10^5$ per bin

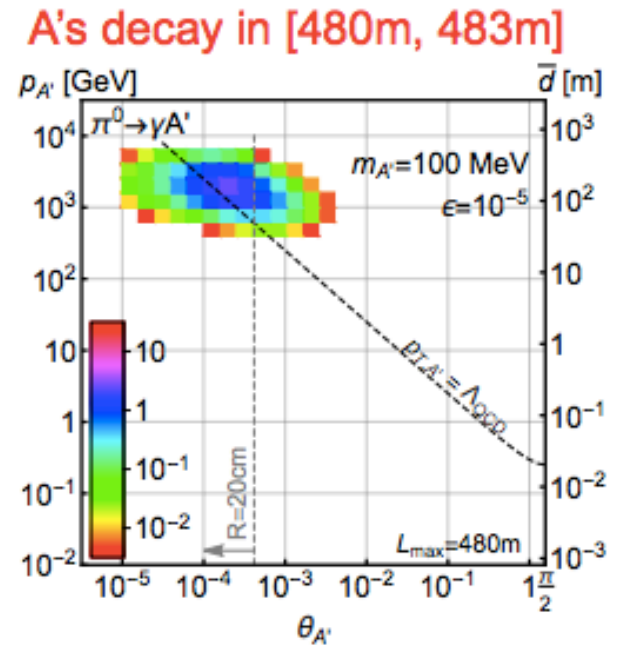

- Only highly boosted $\sim \text{TeV}$ A's decay in FASER
- Rates again suppressed by decay requirement
- But still $N_{A'} \sim 100$ signal events, and almost all are within 20 cm of "on axis"

note this is an old slide, and FASER volume $R=10\text{cm}$ now!

DARK PHOTONS IN FASER

Leads to a projected sensitivity (as a function of luminosity)

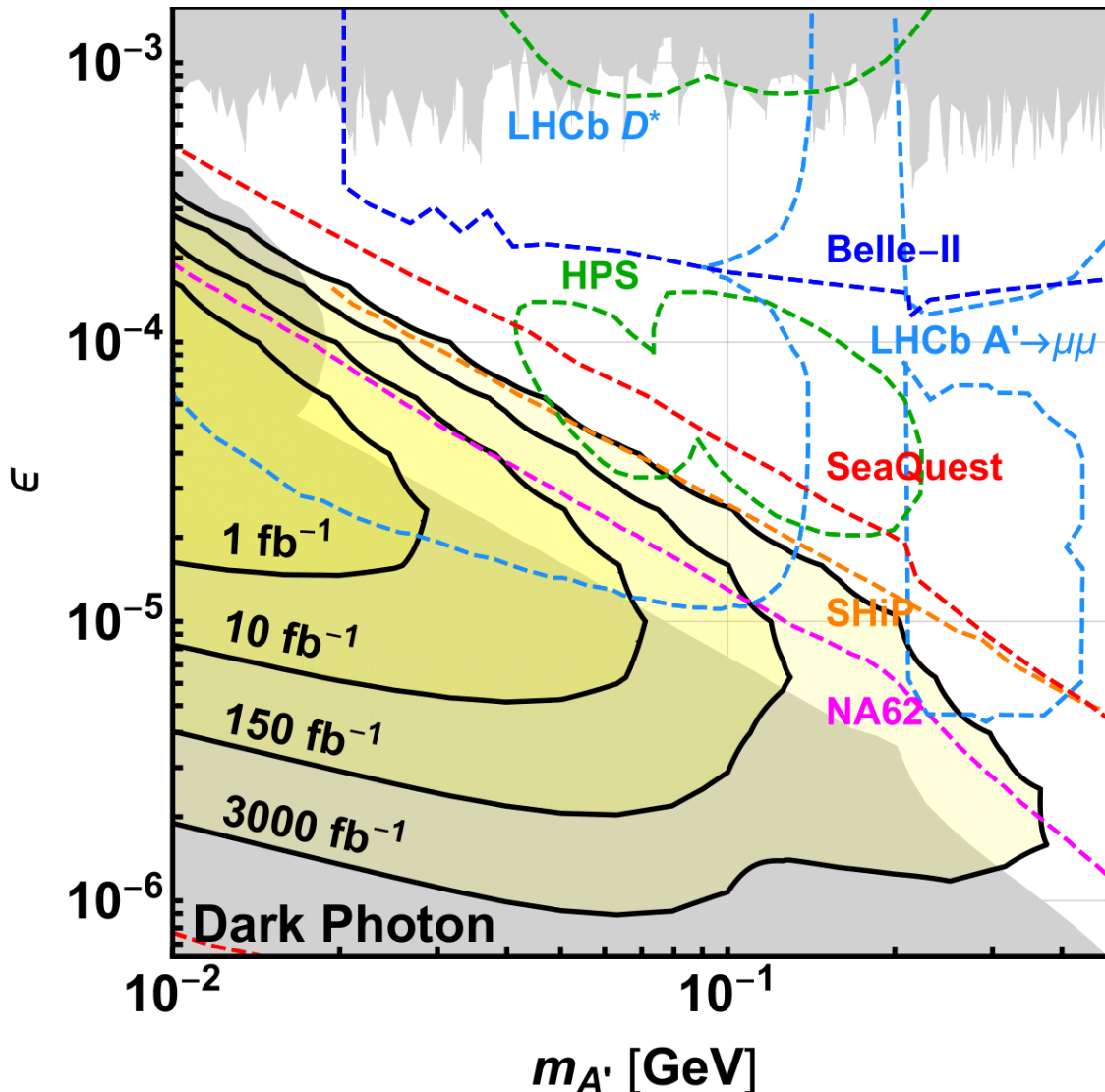

- Start to explore unconstrained space even with 1/fb
- Significant discovery potential with 150/fb (expected Run-3 dataset)

Plot assumes 0 background and 100% efficiency. However contours little effected by $O(1)$ change in efficiency. Signal topology striking, so believe that 0-background is reasonable assumption.

THE T112 ENVIRONMENT

BEAM BACKGROUNDS

- FLUKA simulations and *in situ* measurements have been used to assess the backgrounds expected in FASER
- FLUKA simulations studied particles entering FASER from:
 - IP1 collisions (shielded by 100m of rock)
 - off-orbit protons hitting beam pipe aperture in dispersion suppressor (close to FASER) (following diffractive interactions in IP1)
 - beam-gas interactions
- Expect a flux of high energy muons ($E > 10$ GeV) of $0.4 \text{ cm}^{-2} \text{ s}^{-1}$ at FASER for $2 \times 10^{34} \text{ cm}^{-2} \text{ s}^{-1}$ luminosity from IP1 collisions
 - Confirmed by *in situ* measurements in 2018 running (emulsion detector and TimePix BLM)

Fluence rate ($\text{GeV}^{-1} \text{ cm}^{-2} \text{ s}^{-1}$) for muons: 10 GeV threshold

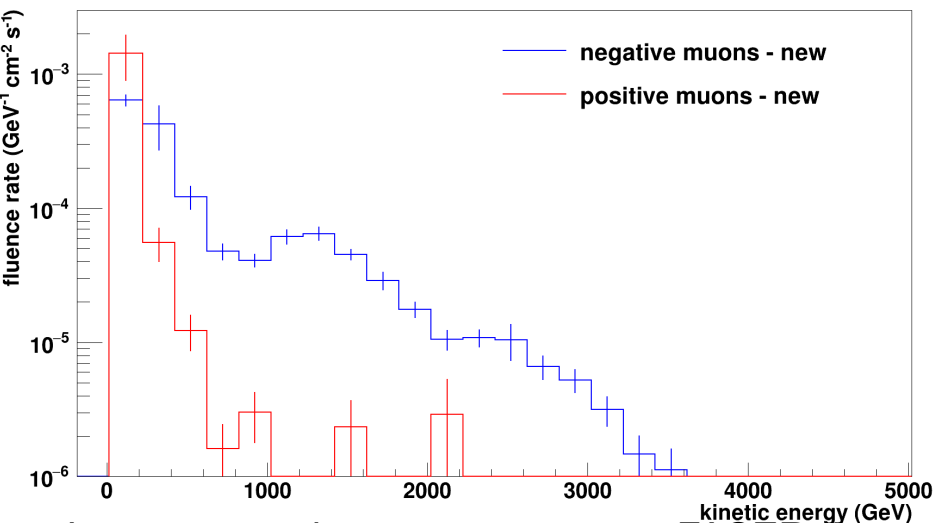

Large muon charge asymmetry at FASER due to LHC bending magnets

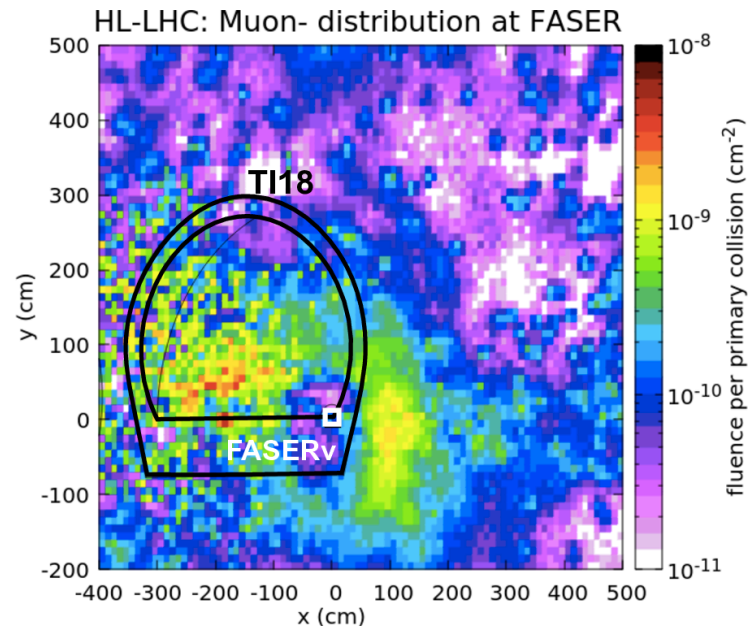

TI12 RADIATION LEVEL

- Radiation level predicted to be very low in TI12 due to dispersion function of LHC at this location
 - Radiation comes from off-momentum protons (following diffractive processes in IP1) hitting beam aperture, and causing showers
 - Dispersion function defines where this happens – FASER location one of the quietest!
- Measurements by BatMon radiation monitor in 2018 running confirm FLUKA expectations of:
 - less than 5×10^{-3} Gy/year
 - less than 5×10^7 1 MeV neutron equivalent fluence / year
- FASER detector does not need radiation hard electronics

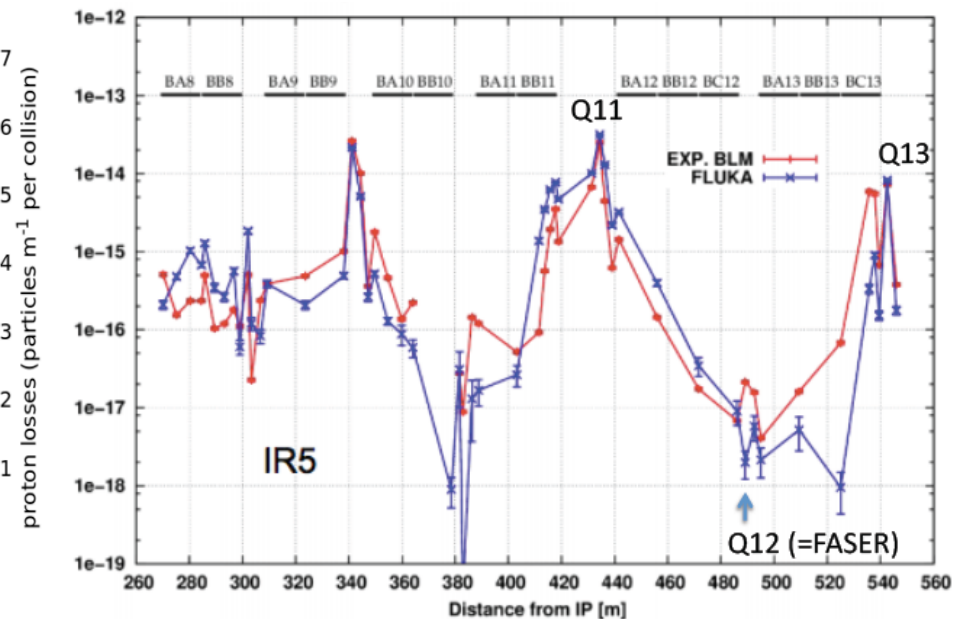
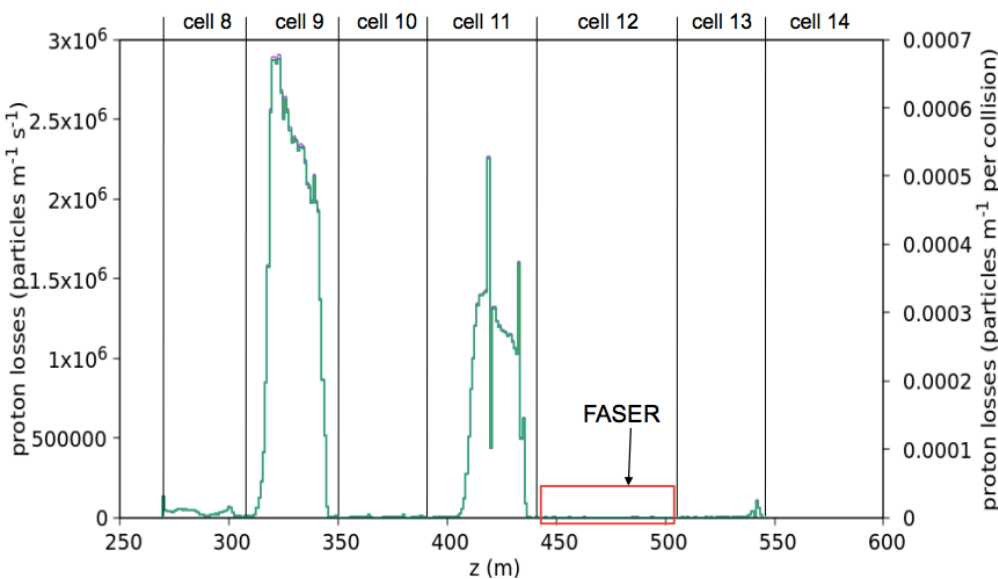

THE FASER DETECTOR

THE FASER DETECTOR

The detector consists of:

- Scintillator veto
- 1.5m long decay volume
- 2m long spectrometer
- EM calorimeter

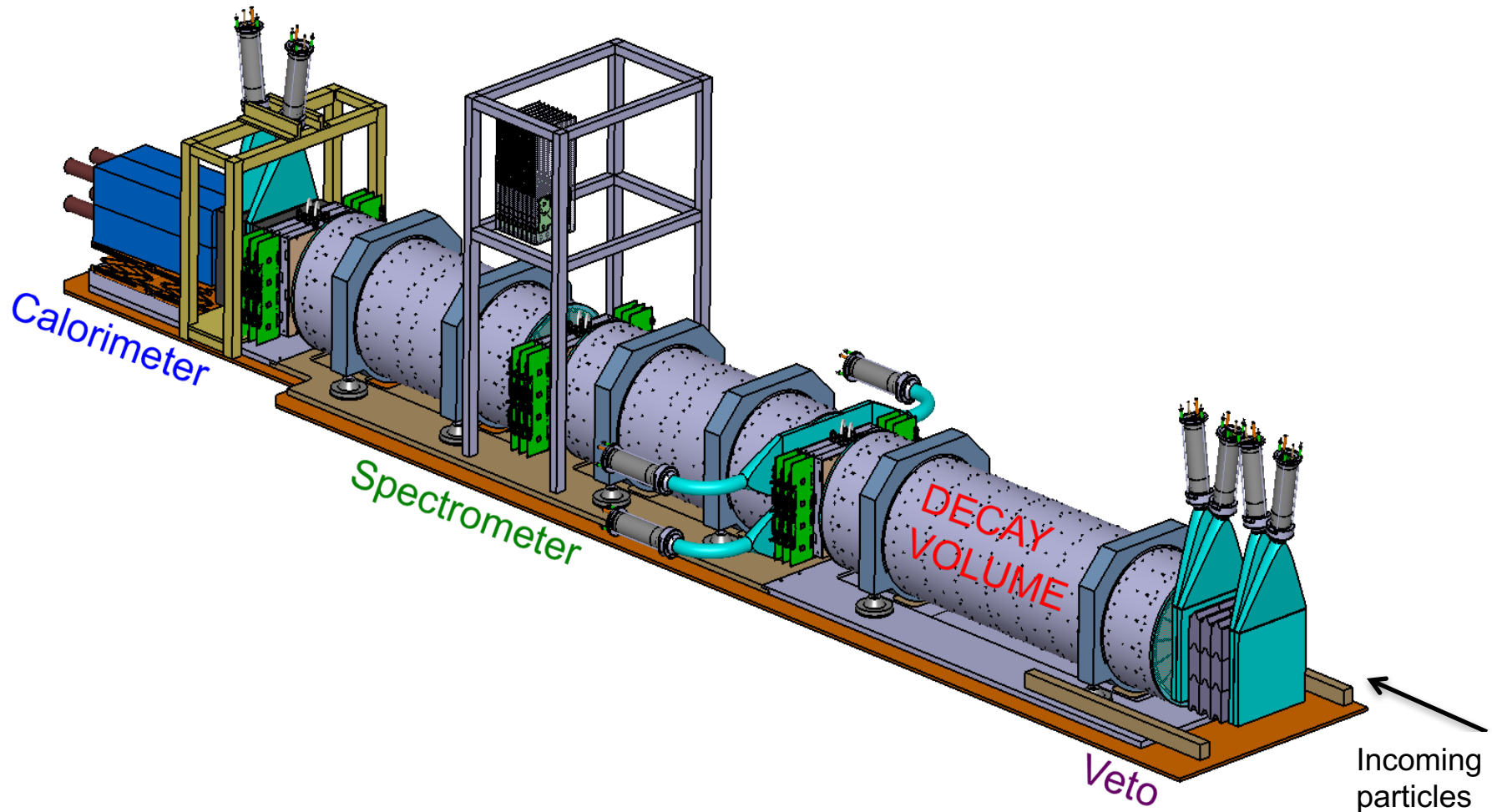

THE FASER DETECTOR

The detector consists of:

- Scintillator veto
- 1.5m long decay volume
- 2m long spectrometer
- EM calorimeter

Signal signature

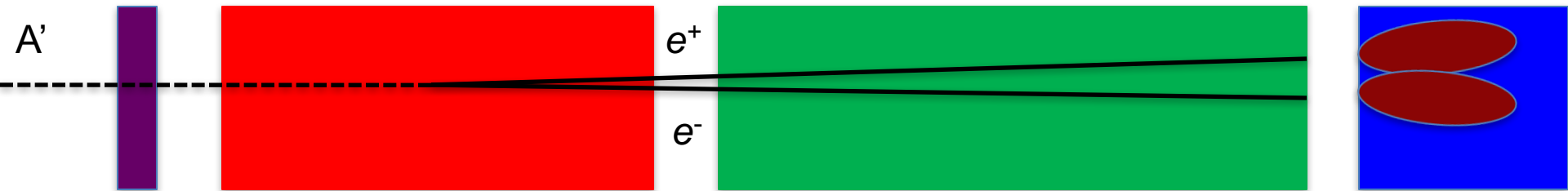

1. No signal in the veto scintillator;
2. Two high energy oppositely charged tracks, consistent with originating from a common vertex in the decay volume, and with a combined momentum pointing back to the IP;
3. For $A' \rightarrow e^+e^-$ decay: Large EM energy in calorimeter. EM showers too close to be resolved.

Magnets needed to separate the A' decay products sufficiently to be able to be resolved in tracker

THE FASER DETECTOR

The detector consists of:

- Scintillator veto
- 1.5m long decay volume
- 2m long spectrometer
- EM calorimeter

Signal A' **FASER Detector Philosophy**

Given the very tight timeline between experiment approval and installation & the limited budget we have focused on:

- Detector that can be constructed and installed **quickly & cheaply**
- Have tried to re-use existing detector components where possible
- Aimed for a simple, robust detector (access difficult)
- Tried to minimize the services to simplify the installation and operations

Many challenges of the large LHC experiments not there for FASER:

1. No s
 2. Two
 3. For
- trigger rate $\sim 500\text{Hz}$ (mostly single muon events)
 - low radiation
 - low occupancy / event size

Magnets needed to separate the A' decay products sufficiently to be able to be resolved in tracker

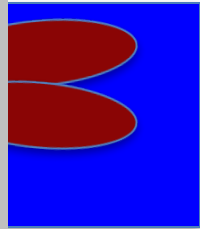

vertex in

ed.

FASER MAGNETS

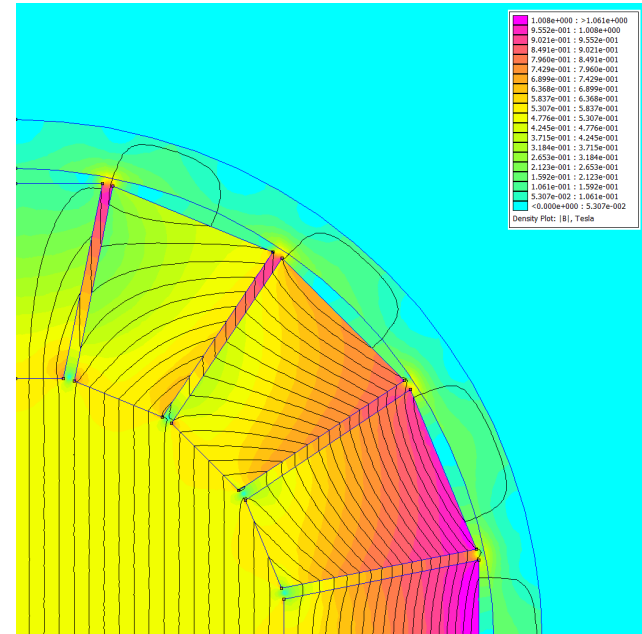
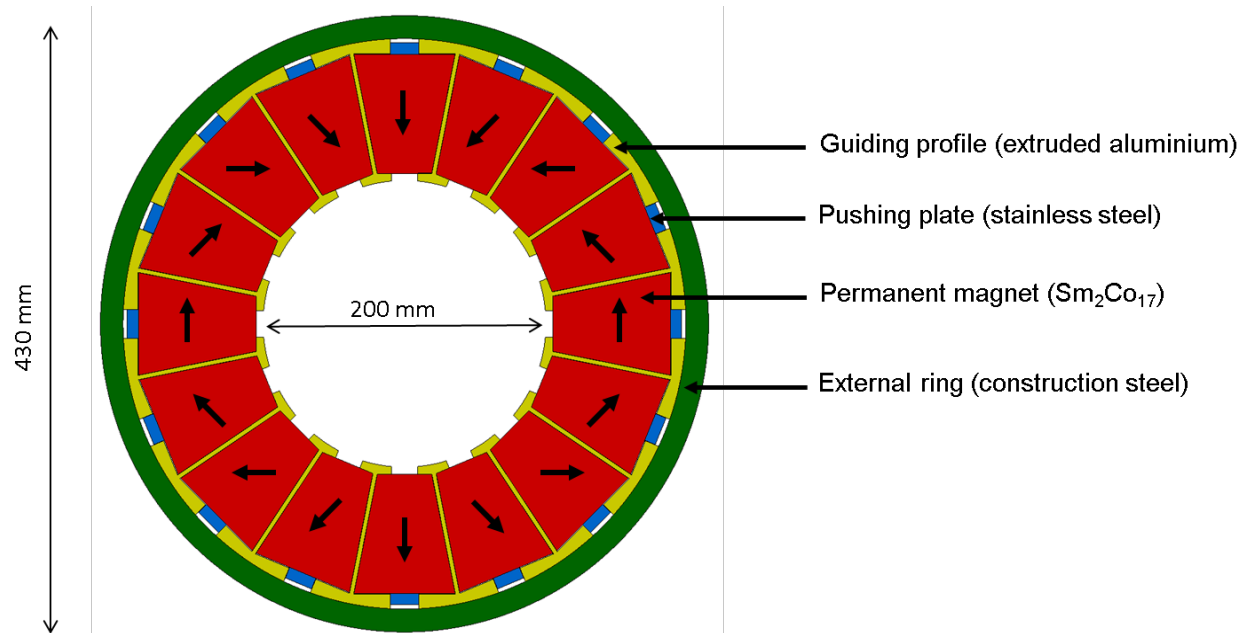

- The FASER magnets are 0.55T permanent dipole magnets based on the Halbach array design
 - Thin enough to allow the LOS to pass through the magnet center with minimum digging to the floor in TI12
 - Minimize needed services (power, cooling etc..)
- Designed and to be constructed by TE-MS-C group at CERN

FASER MAGNETS

10% of magnetic blocks received in Nov 2019, used for QA and to test magnet production procedure.

Main order released in Dec 2019, magnetic blocks for first magnet produced and at CERN.

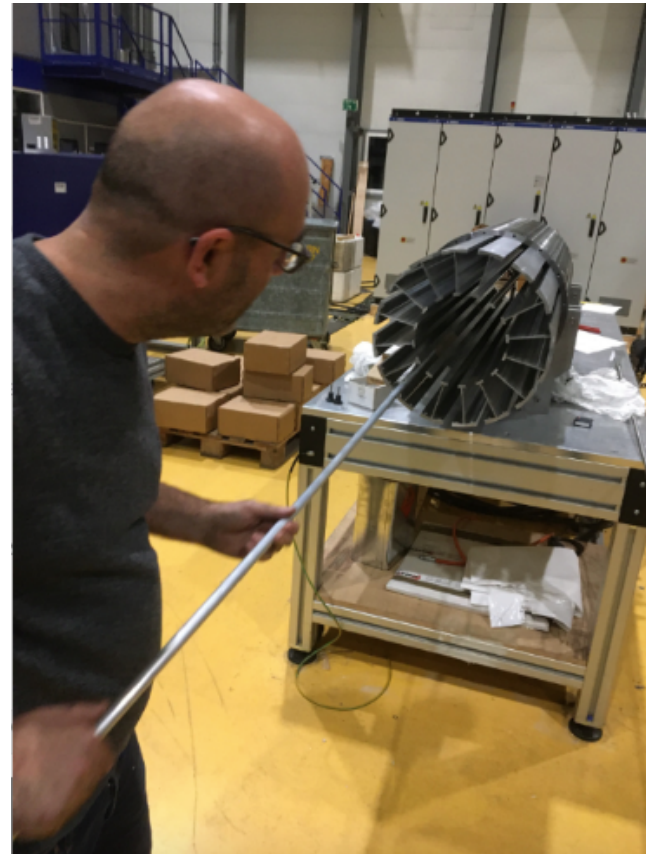
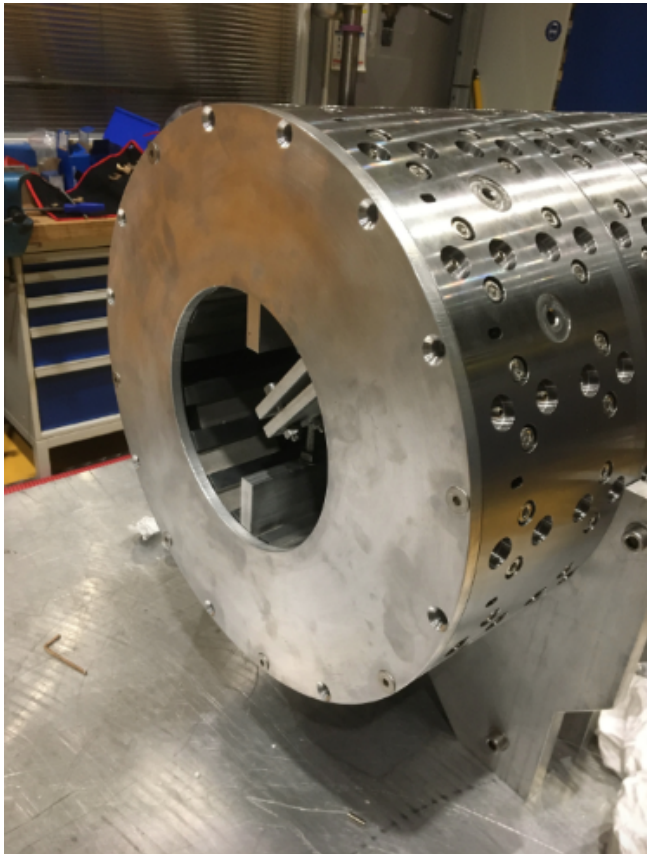

FASER TRACKER

- FASER Tracker needs to be able to efficiently separate very closely spaced tracks
- The FASER Tracker is made up of 3 tracking stations
- Each containing 3 layers of two pairs of single-sided silicon micro-strip sensors
 - Spare ATLAS SCT modules are used
 - 80 μ m strip pitch, 40mrad stereo angle (17 μ m / 580 μ m resolution)
 - precision measurement in bending (vertical) plane
 - **Many thanks to the ATLAS SCT collaboration!**
- 8 SCT modules give a 24cm x 24cm tracking layer
- 9 layers (3/station, 3 stations) => 72 SCT modules needed for the full tracker
 - 10⁵ channels in total

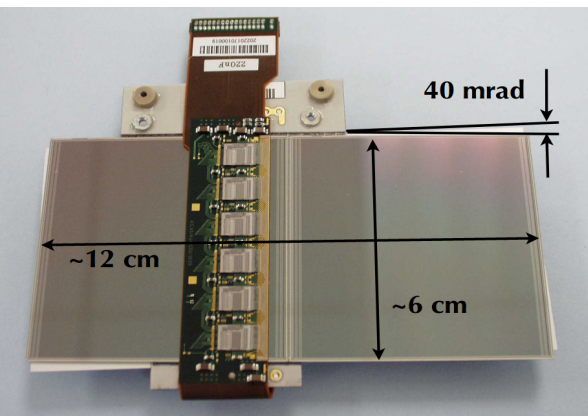

SCT module

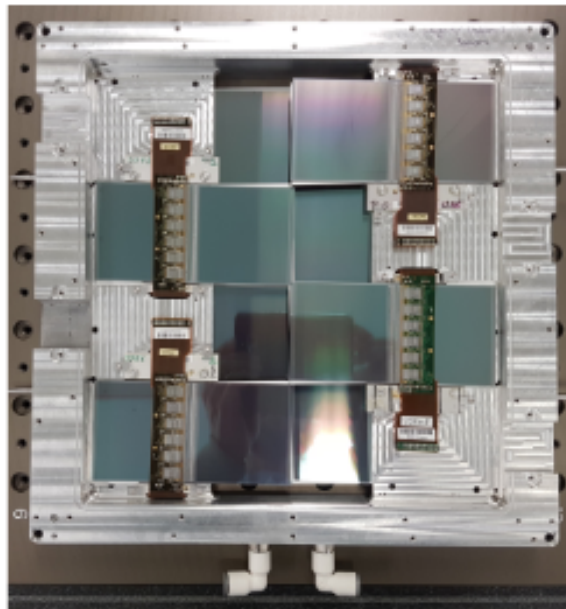

Tracking layer

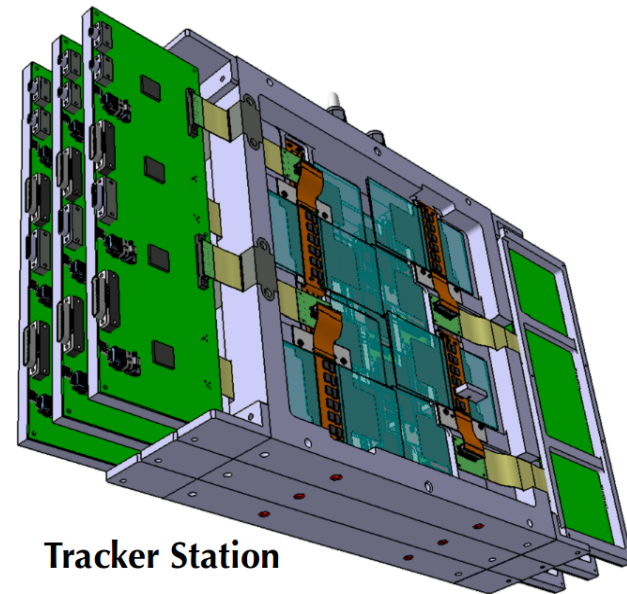

Tracker Station

FASER TRACKER: MODULE QA

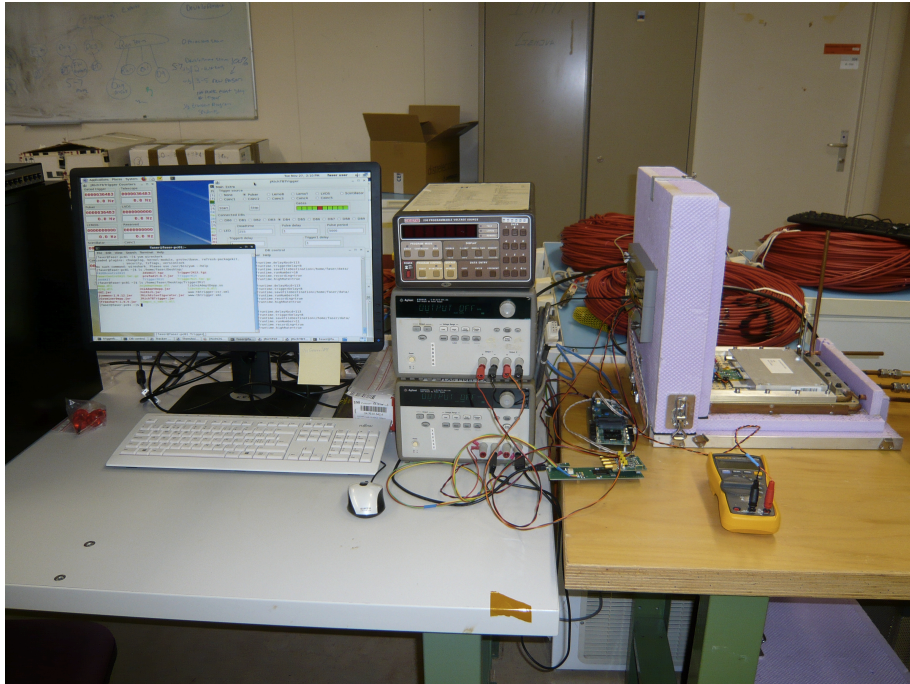

SCT modules used had passed ATLAS QA in ~2005 and then been kept in storage. Important to test their functionality.

SCT module QA at CERN in March 2019. Identified > 80 good spare modules – more than enough for FASER needs.

Performance seems not to be degraded by long term storage/age.

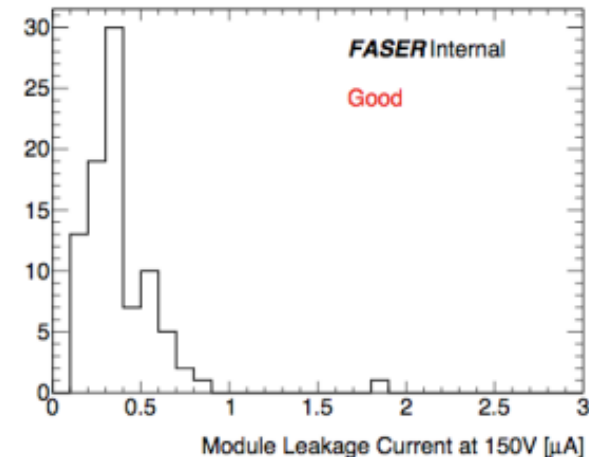
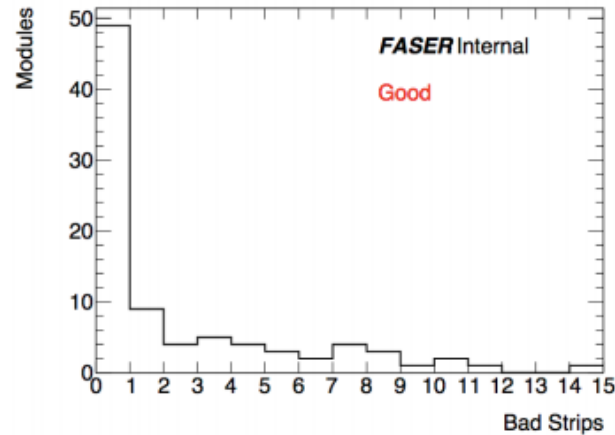
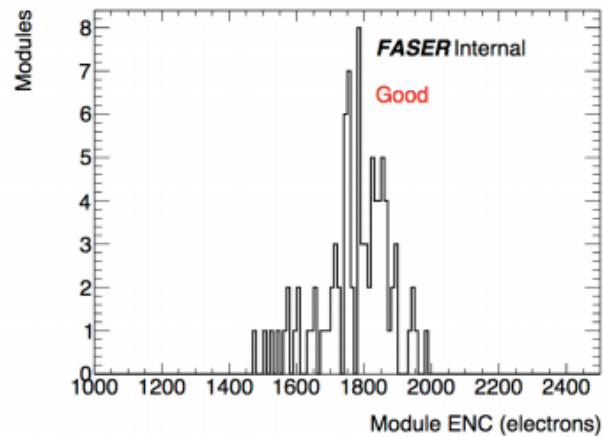

FASER TRACKER: READOUT/COOLING

Decided to not use the ATLAS SCT readout to simplify the system.
Custom made flex cable used to connect pigtail on SCT module to custom PCB patch panel which separates out power (HV, LV), readout, monitoring lines.
Data processed by custom FPGA-based readout board a few meters from the detector

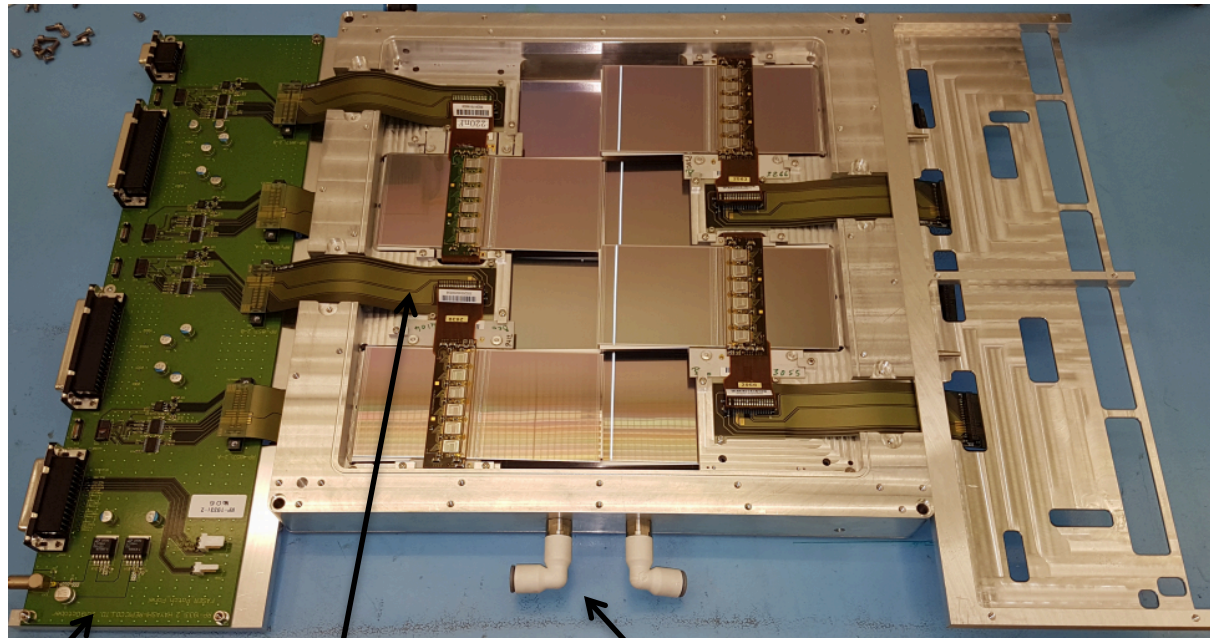

Patch-panel

Flex cable

Cooling loop

Due to low radiation – silicon operated at room temperature. Still need to remove heat from on detector ASICS (5W/module => 360W for the detector). Use simple water chiller (temp ~10-15degrees) – cooling pipe around outside of aluminium frame. Thermal properties validated with FEE simulation and measurements.

CALORIMETER

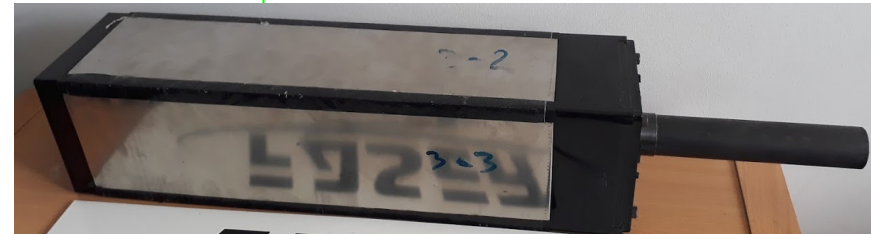
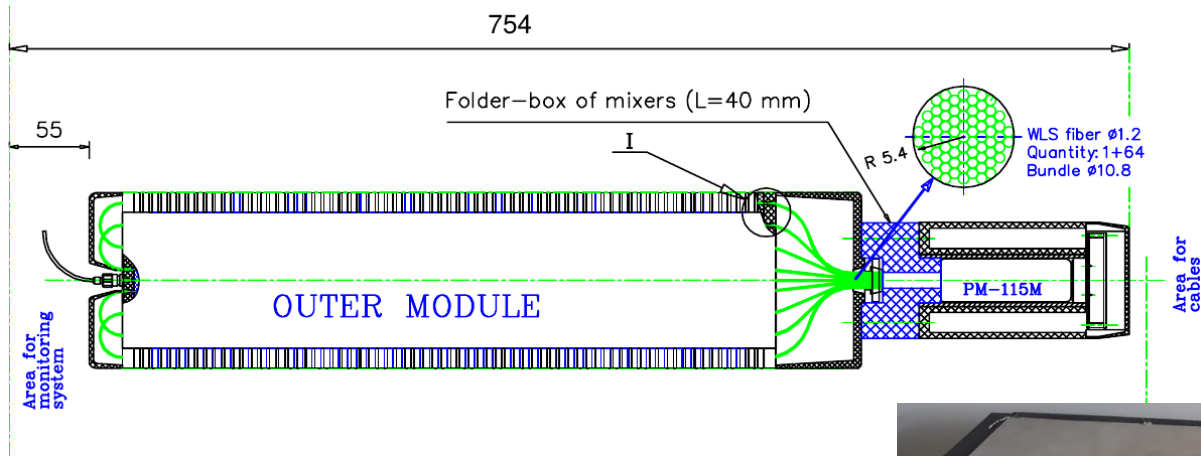

- FASER EM calorimeter for:
 - Measuring the EM energy in the event
 - Electron/photon identification
 - Triggering
- Uses 4 spare LHCb outer ECAL modules
 - **Many thanks to LHCb** for allowing us to use these!
 - PMTs also from LHCb, although new voltage divider needed
 - 66 layers of lead/scintillator, light out by wavelength shifting fibers
 - 25 radiation lengths long
 - Readout by PMT (no longitudinal shower information)
 - Only 4 channels in full calorimeter
 - Dimensions: 12cm x 12cm – 75cm long (including PMT)
 - Provides ~1% energy resolution for 1 TeV electrons
 - Resolution will degrade at higher energy due to not containing full shower in calorimeter; Energy scale will depend on the calibration

CALORIMETER – INITIAL QA

Module under test

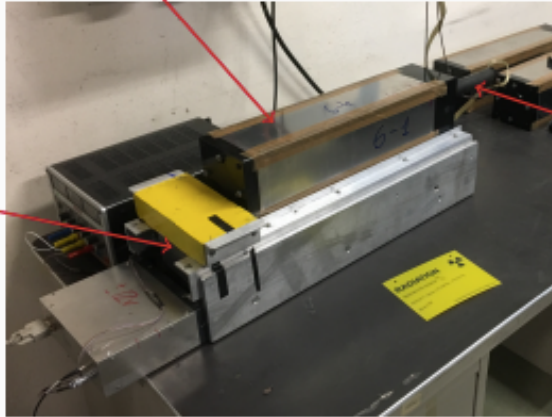

^{137}Cs -source
662 keV γ

LHCb PMT
(with their PS
and readout)

Testing of calorimeter modules at CERN in March 2019 with a source showed expected response in all modules tested.

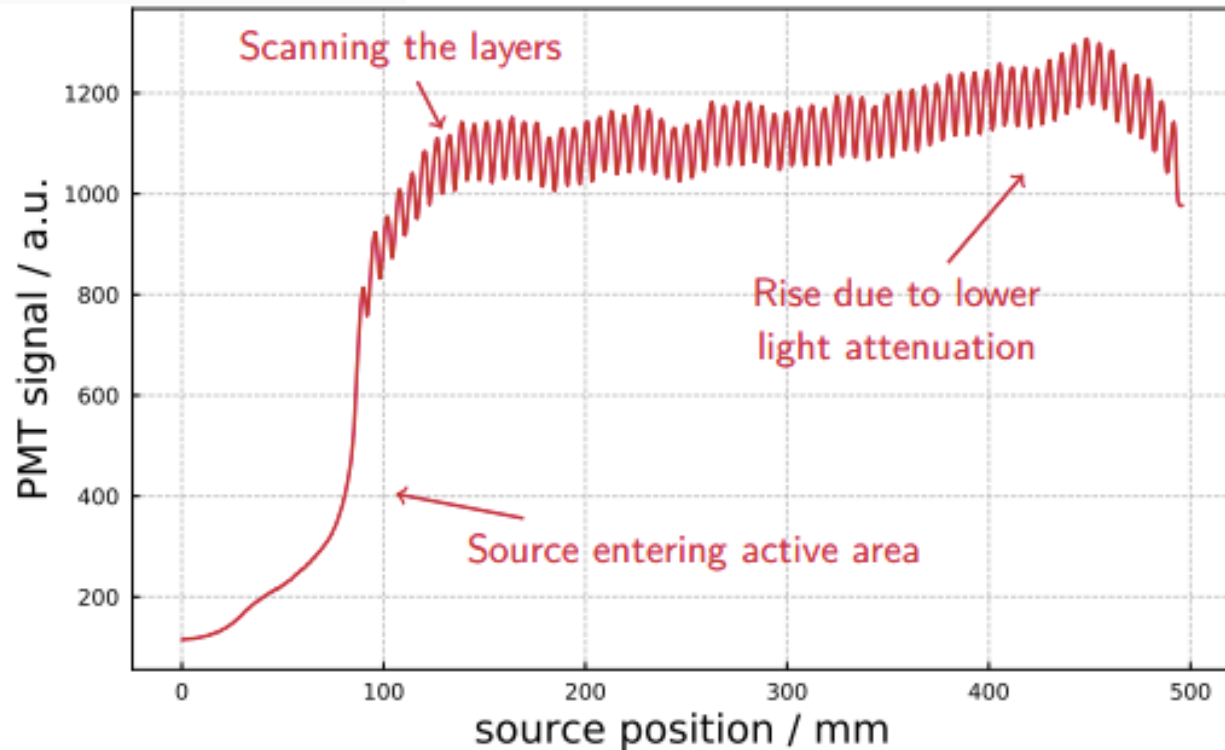

CALORIMETER – COSMIC RAY TESTS

- Cosmic ray test stand used for testing calorimeter response and to calibrate PMTs
 - Calorimeter signal is read when scintillators see coincident signals from cosmic muon
 - Read-out very close to final design
- Good agreement with LHCb pulses observed:

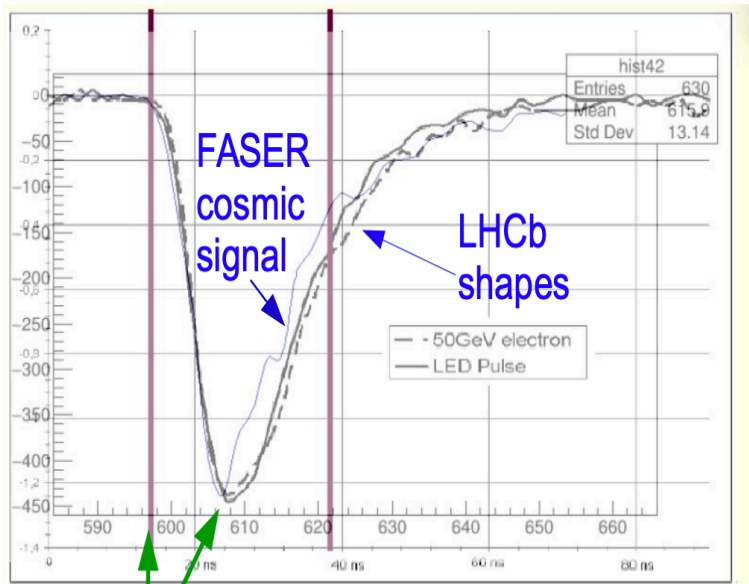

~10 ns
rise time

Rise time dominated by WLS fibres

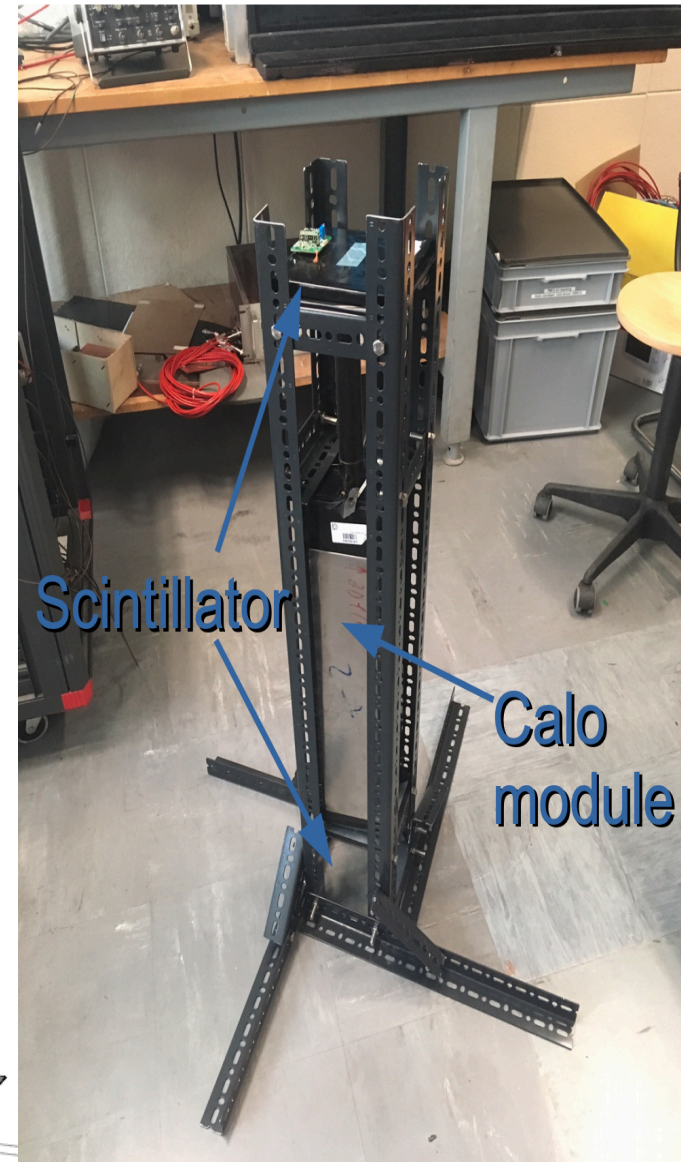
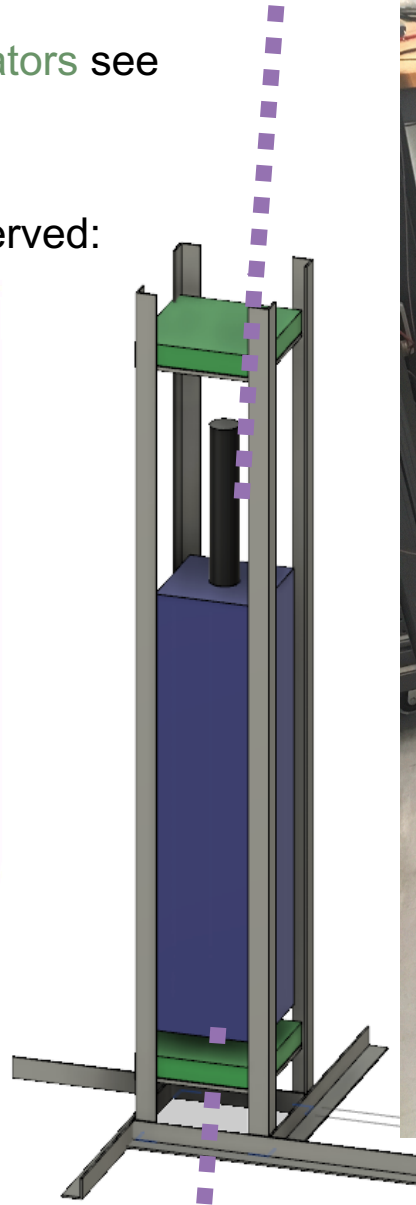

SCINTILLATOR SYSTEM

Scintillators used for:

- Vetoing incoming charged particles
 - Very high efficiency needed ($O(10^8)$ incoming muons in 150/fb)
- Triggering
- Timing measurement
 - ~ 1 ns resolution
- Simple pre-shower for Calorimeter

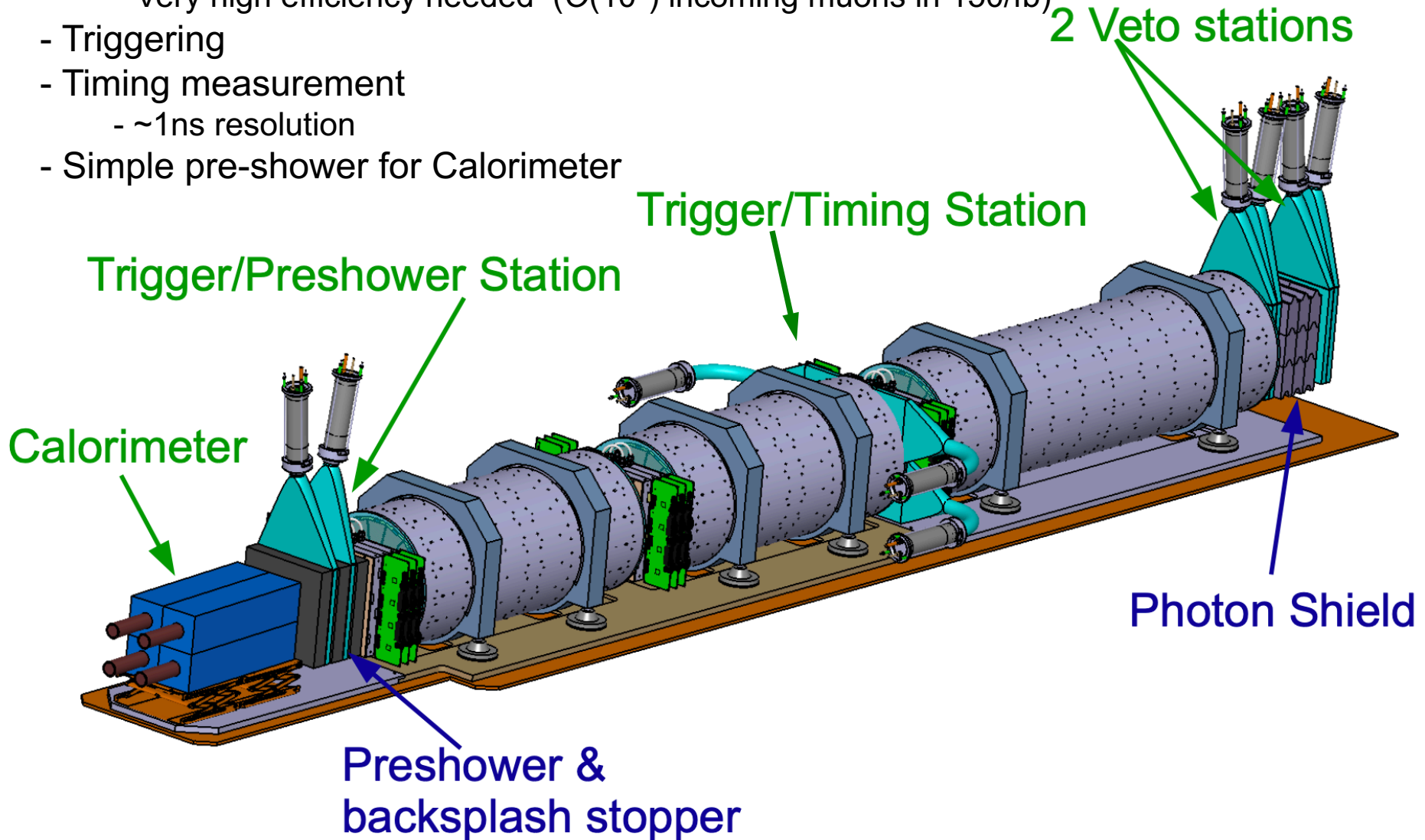

SCINTILLATORS - PRODUCTION

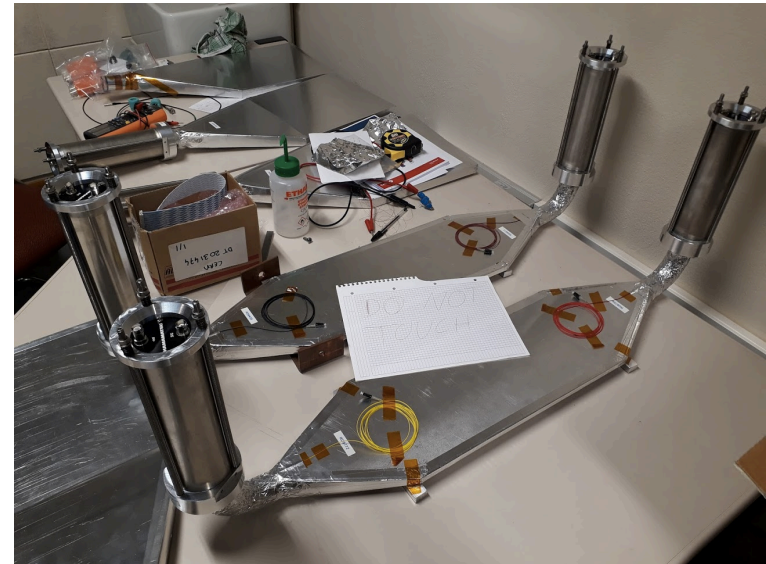
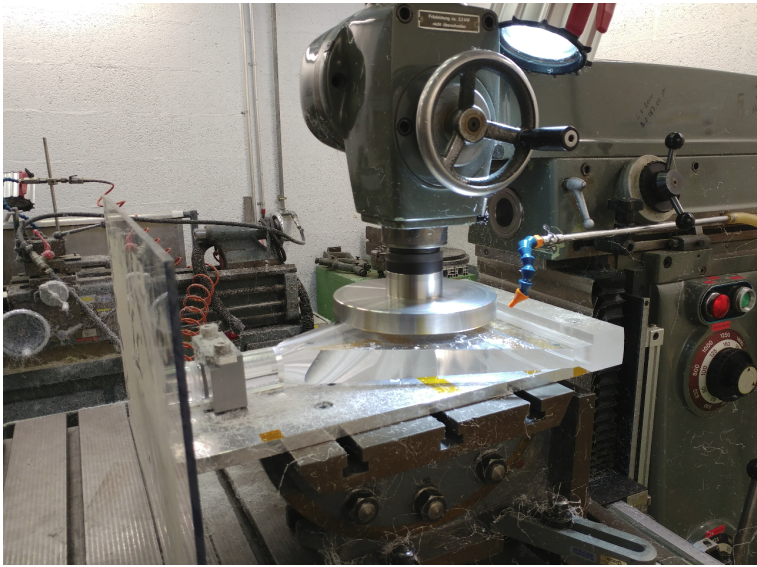

Many thanks to the CERN scintillator lab for producing the scintillators and light guides.

SCINTILLATORS - TESTING

- Use cosmic muons to measure the scintillator response & inefficiency
- Efficiency $>99.9\%$ measured
 - Within specification

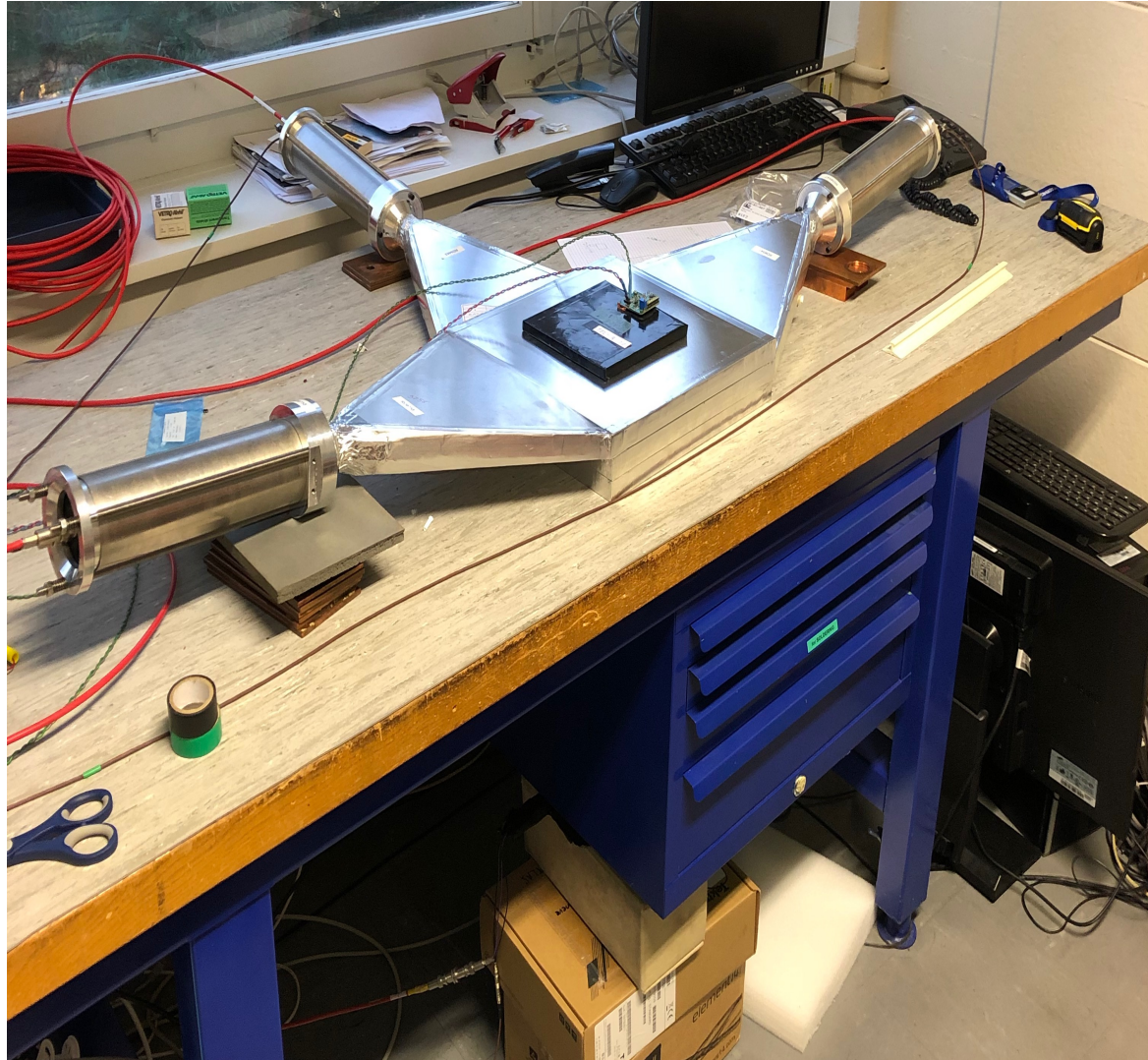

CALORIMETER/SCINTILLATORS – READOUT

The calorimeter and Scintillators use a common readout.



- The PMT signals are digitized by a CAEN vx1730 digitizer board:
- 16 channels
 - 500 MHz sampling frequency
 - 14-bit precision
 - Provides 8 independent trigger outputs

TDAQ OVERVIEW

- Trigger an OR of signals from scintillators and calorimeter
 - Plan to trigger on all particles entering FASER, but could pre-scale events with incoming charged particle if needed
- Expected maximum trigger rate $\sim 500\text{Hz}$ from incoming muons
- Expected maximum bandwidth $\sim 15\text{MB/s}$
 - Event size ($\sim 25\text{KB}$) dominated by PMT waveforms where readout a long time around pulse to allow offline quality checks (configurable)
- Trigger Logic Board is same general purpose FPGA board as Tracker Readout Board but with different firmware/adaptor-card
- Readout and trigger logic electronics in T112 tunnel
 - Not sufficient time to send signals to the surface and back
 - Event builder and DAQ s/w running on PC on surface (600m away)
- No trigger signals sent/received from ATLAS

TDAQ ARCHITECTURE

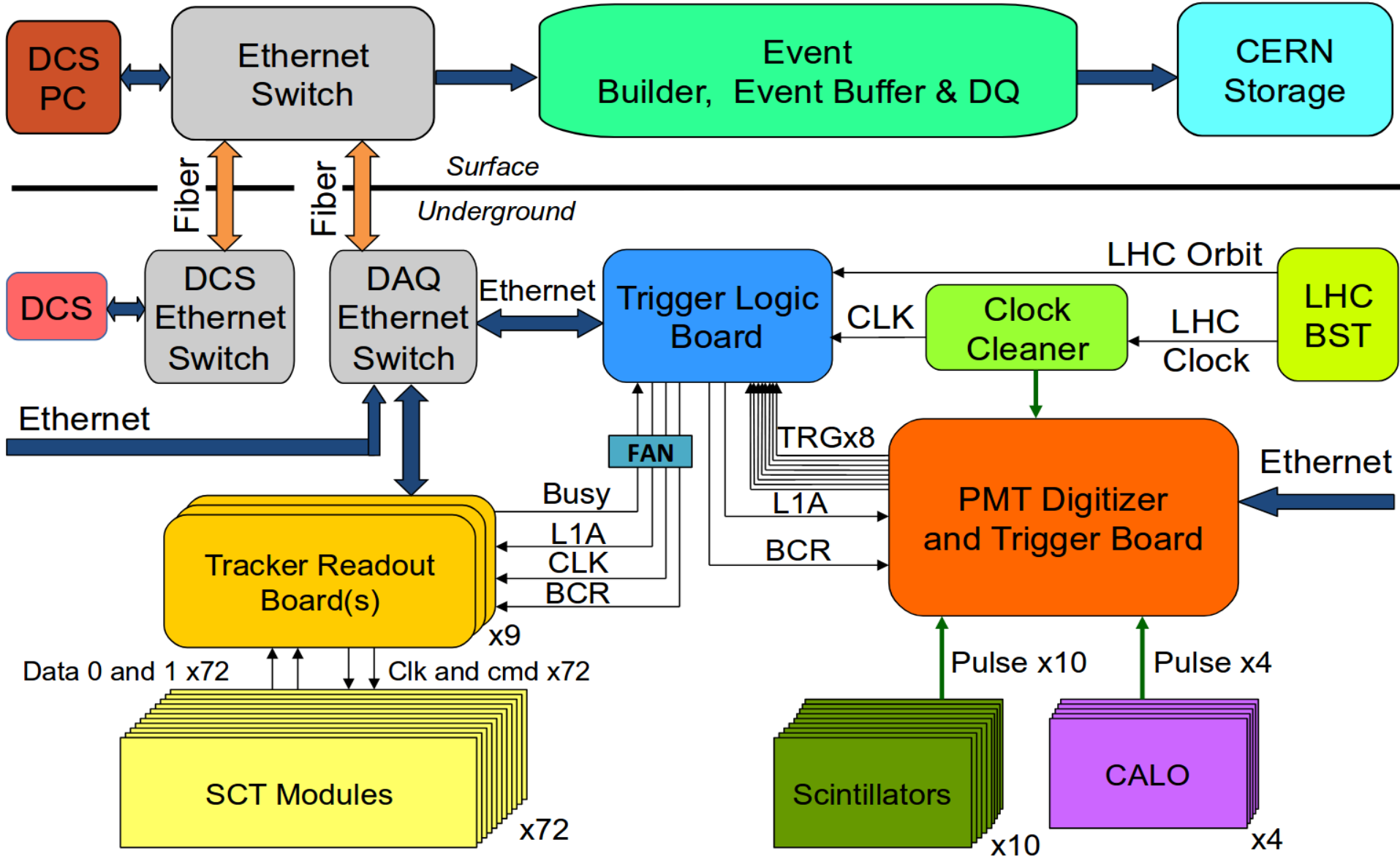

TDAQ STATUS

- All hardware for Tracker Readout and Trigger Logic produced and tested
- All firmware implemented and tested
- DAQ s/w for all readout boards implemented and tested
- Combined system tests had started before CERN shutdown

TDAQ test setup

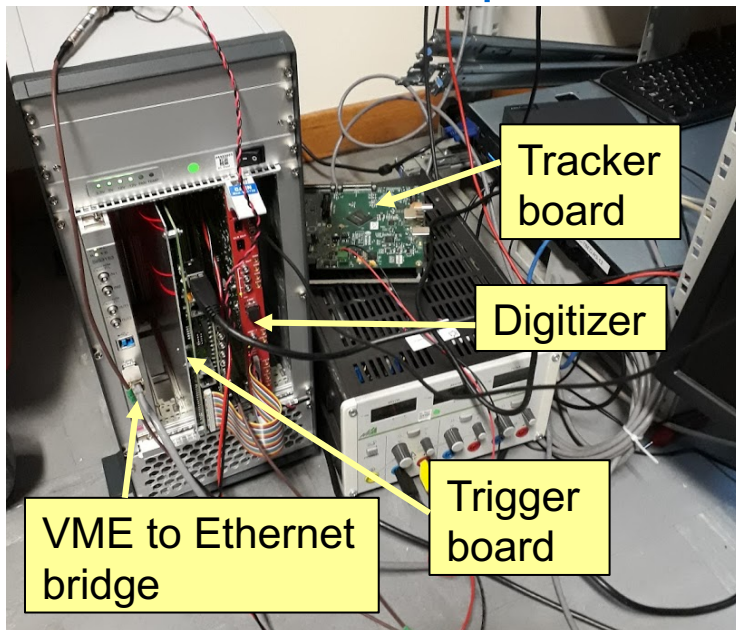

Web-based run-control

Monitoring Link

DAQ software



Configuration

- config_emulator_localhost.json
- emulator_localhost_full.json
- emulator_remote_full.json
- config_test_full_chain.json
- config_test_monitor.json
- valid-config.json
- current.json
- config_emulator_localhost_withMonitoring.json
- configXXX.json
- config2.json

CONTROLS

INITIALISE START STOP SHUTDOWN

RUN INFORMATION

Run	number: 100	Starting Time: 8/21/2019 11:07:03
Physics	7533 events	12 Hz
Monitoring	475 events	1 Hz
Calibration	0 events	0 Hz

PhysRate * MonitoringRate * CalibrationRate

PhysRate

STATUS AND SETTINGS

triggergenerator	CONFIG	LOG	INFO	RUN
frontemulator01	CONFIG	LOG	INFO	RUN
frontemulator02	CONFIG	LOG	INFO	RUN
frontreceiver01	CONFIG	LOG	INFO	RUN
frontreceiver02	CONFIG	LOG	INFO	RUN
eventbuilder01	CONFIG	LOG	INFO	RUN
datalogger01	CONFIG	LOG	INFO	RUN

ADD

DETECTOR SUPPORT

- Main requirements of detector support:
 - Keep tracking stations well aligned in vertical plane ($O(100\mu\text{m})$)
 - Align magnets to each other and LOS within a few mm
 - Allow detector to follow changes in LOS due to changing crossing angle in IP1
 - Crossing angle moves LOS by $\sim 7\text{cm}$
 - Crossing direction can change in YETS

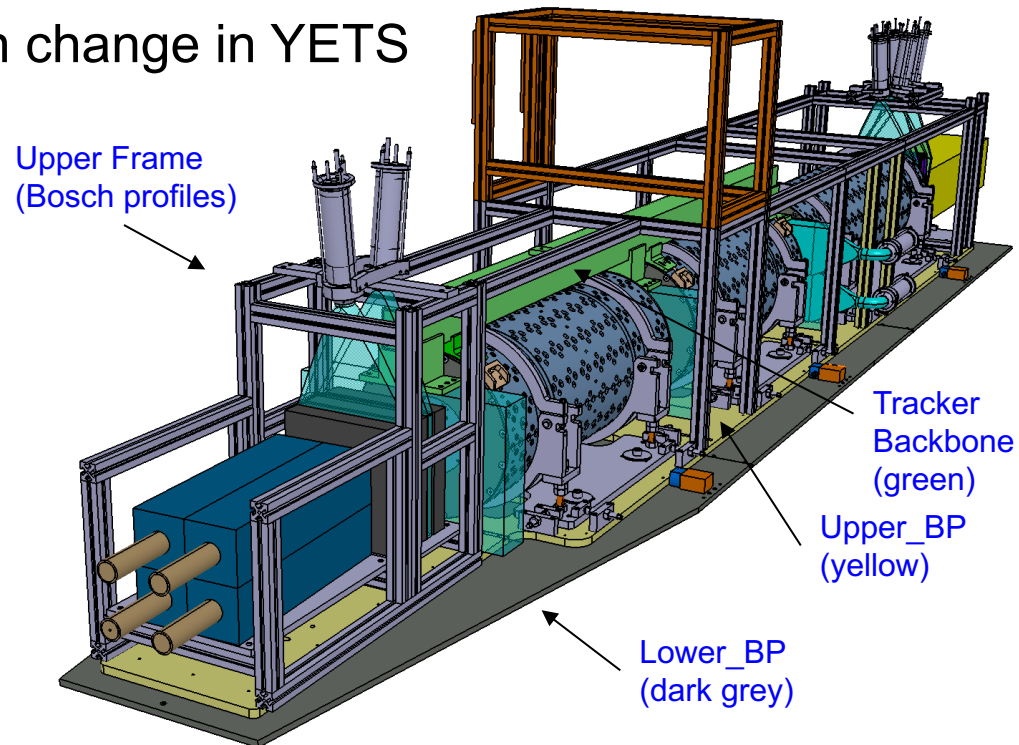

TUNNEL INFRASTRUCTURE

CIVIL ENGINEERING WORK

Civil engineering work in T112 to allow FASER installation finished on schedule, just before CERN shutdown! Significant cleanup work in T112 before digging could begin.

Many constraints in planning this:

- Strong requirement on no dust in the LHC during LS2
- Little available time for doing the work in LS2
- Extremely important to not effect the tunnel stability during the works
- The drainage must be maintained during and after the works



INFRASTRUCTURE WORK IN T112

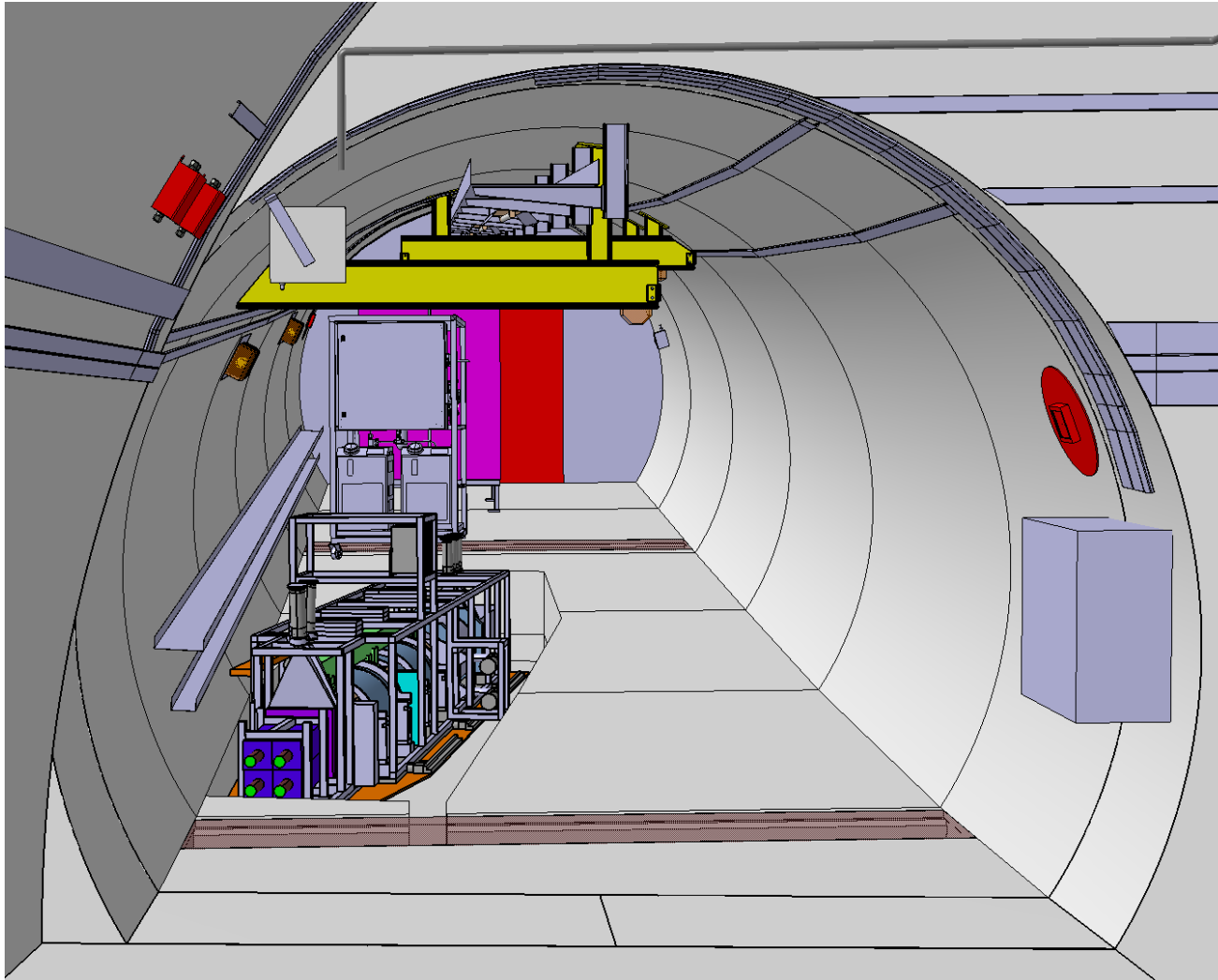

Next steps are to install:

- Transport equipment
- Lights
- Racks
- Power
- Optical Fibers
- Compressed Air
- Cooling Unit
- Cable Trays

INFRASTRUCTURE WORK IN UJ12

Access to TI12 is over the LHC machine- complicates the transport & safety

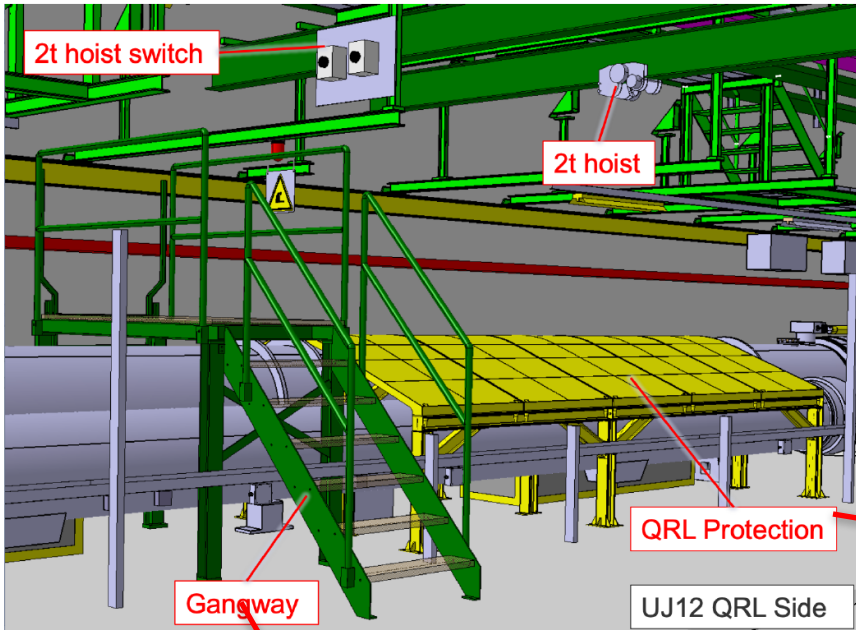

FUTURE UPGRADE: FASER 2

POSSIBLE FUTURE UPGRADE - FASER 2

- A potential upgraded detector for HL-LHC running, would increase sensitivity further
- Increasing detector radius to 1m would allow sensitivity to new physics produced in heavy meson (B, D) decays increasing the physics case beyond just the increased luminosity

FASER 2 therefore becomes very strong compared to low energy experiments for certain models (dark Higgs), due to large B/D production rates at LHC:

$$N_B/N_\pi \sim 10^{-2} \quad (\sim 10^{-7} \text{ at beam dump expts})$$

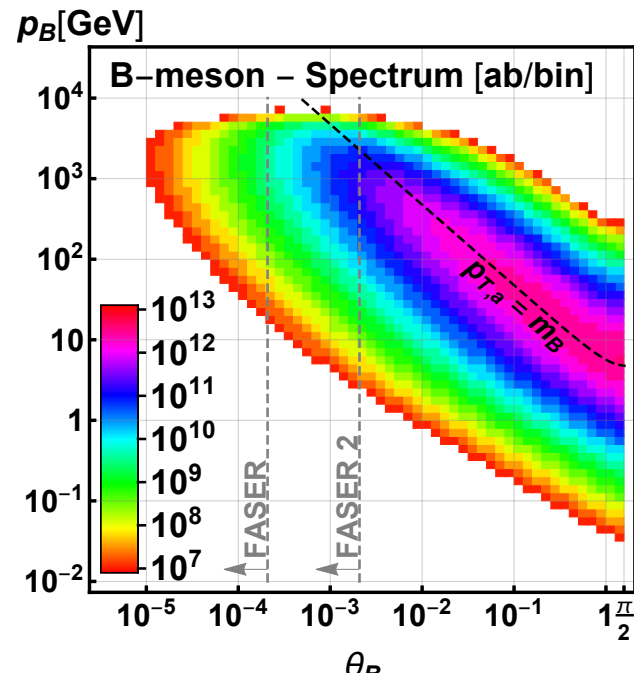
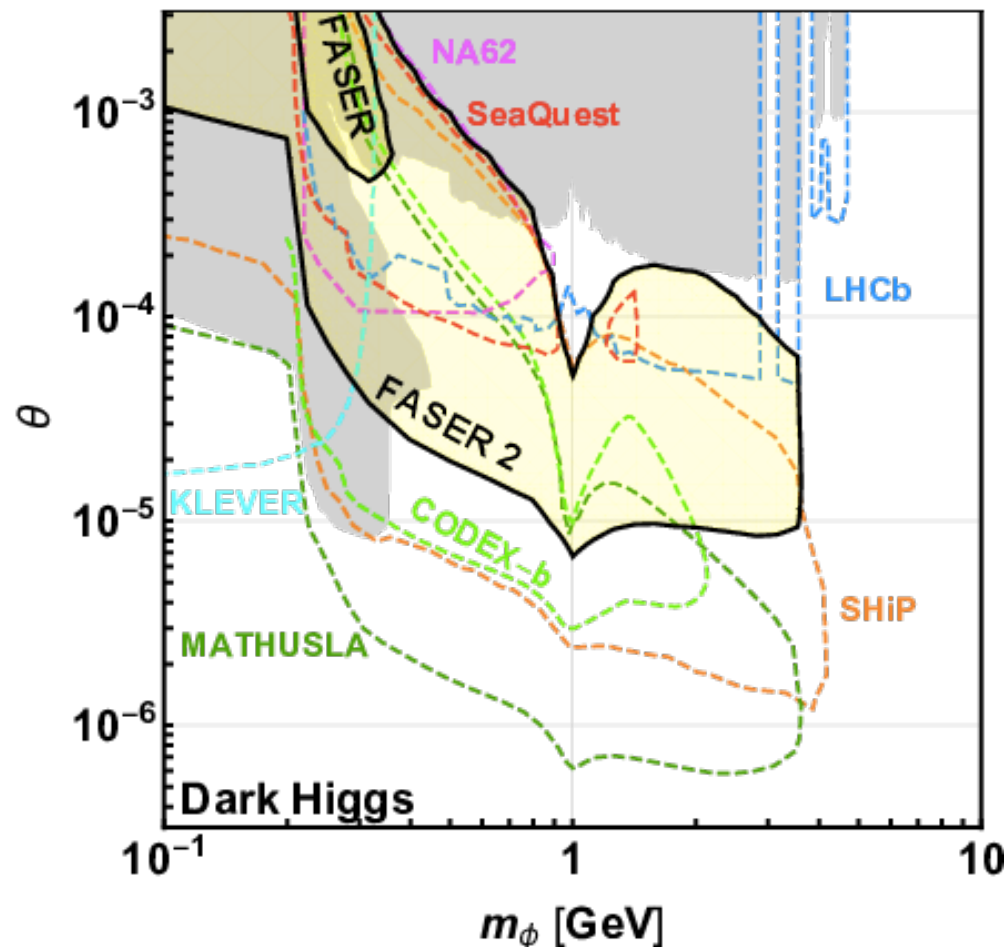

FASER 2 – Physics reach

- FASER 2 increases the set of models that can be targeted
- Sensitivity for all models with renormalizable couplings (dark photon, dark Higgs, HNL); ALPs with all types of couplings (γ , f , g); etc...

Benchmark Model	FASER 1	FASER 2	References
BC1: Dark Photon	√	√	Feng, Galon, Kling, Trojanowski, 1708.09389
BC1': $U(1)_{B-L}$ Gauge Boson	√	√	Bauer, Foldenauer, Jaeckel, 1803.05466; 1811.12522
BC2: Invisible Dark Photon	–	–	–
BC3: Milli-Charged Particle	–	–	–
BC4: Dark Higgs Boson	–	√	Feng, Galon, Kling, Trojanowski, 1710.09387 Batell, Freitas, Ismail, McKeen, 1712.10022
BC5: Dark Higgs with hSS	–	√	Feng, Galon, Kling, Trojanowski, 1710.09387
BC6: HNL with e	–	√	Kling, Trojanowski, 1801.08947 Helo, Hirsch, Wang, 1803.02212
BC7: HNL with μ	–	√	Kling, Trojanowski, 1801.08947 Helo, Hirsch, Wang, 1803.02212
BC8: HNL with τ	√	√	Kling, Trojanowski, 1801.08947 Helo, Hirsch, Wang, 1803.02212
BC9: ALP with photon	√	√	Feng, Galon, Kling, Trojanowski, 1806.02348
BC10: ALP with fermion	√	√	1811.12522
BC11: ALP with gluon	√	√	1811.12522

FASER 2 – Physics reach

- FASER 2 increases the set of models that can be targeted
- Sensitivity for all models with renormalizable couplings (dark photon, dark Higgs, HNL); ALPs with all types of couplings (γ , f , g); etc...

Benchmark Model	FASER 1	FASER 2	References
BC1: Dark Photon	√	√	Feng, Galon, Kling, Trojanowski, 1708.09389
BC1': $U(1)_{B-L}$ Gauge Boson	√	√	Bauer, Foldenauer, Jaeckel, 1803.05466; 1811.12522
BC2: Invisible Dark Photon	–	–	–
BC3: Milli-Charged			
BC4: Dark Higgs			10.09387 12.10022
BC5: Dark Higgs			10.09387
BC6: HNL w			47 212
BC7: HNL with μ		√	47 Helo, Hirsch, Wang, 1803.02212
BC8: HNL with τ	√	√	Kling, Trojanowski, 1801.08947 Helo, Hirsch, Wang, 1803.02212
BC9: ALP with photon	√	√	Feng, Galon, Kling, Trojanowski, 1806.02348
BC10: ALP with fermion	√	√	1811.12522
BC11: ALP with gluon	√	√	1811.12522

Due to short timescale for FASER installation, we have been concentrating on that, and have not thought about the design of the FASER 2 detector in detail. It is clear that we can not just scale up the current detector to $r=1m$ for a number of reasons (magnet, SCT modules etc..)

FASERnu

NEUTRINO MEASUREMENTS IN FASER

A huge number of neutrinos produced in the LHC collisions (hadron decay) traverse the FASER location covering an unexplored neutrino energy regime. FASERnu is an emulsion/tungsten detector to be placed in front of the main FASER detector to detect neutrinos of all flavours.

150/fb @14TeV	ν_e	ν_μ	ν_τ
Main production source	kaon decay	pion decay	charm decay
# traversing FASERnu 25cm x 25cm	$O(10^{11})$	$O(10^{12})$	$O(10^9)$
# interacting in FASERnu (1.2tn Tungsten)	~ 1300	~ 20000	~ 20

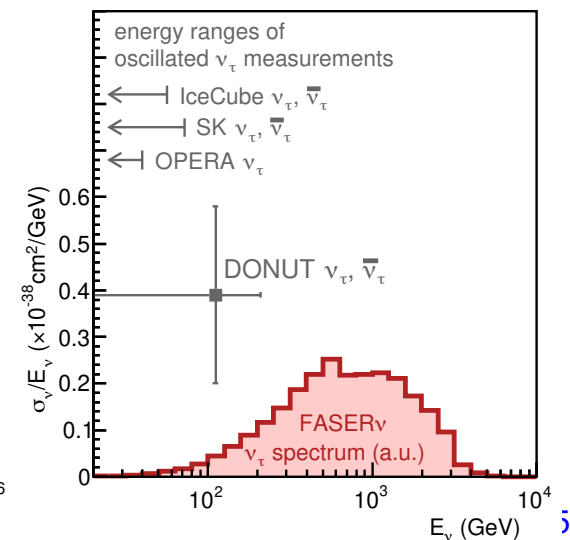
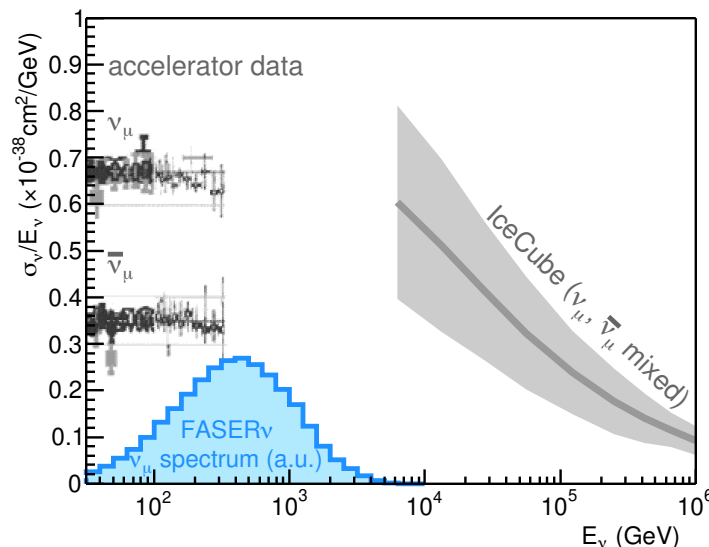
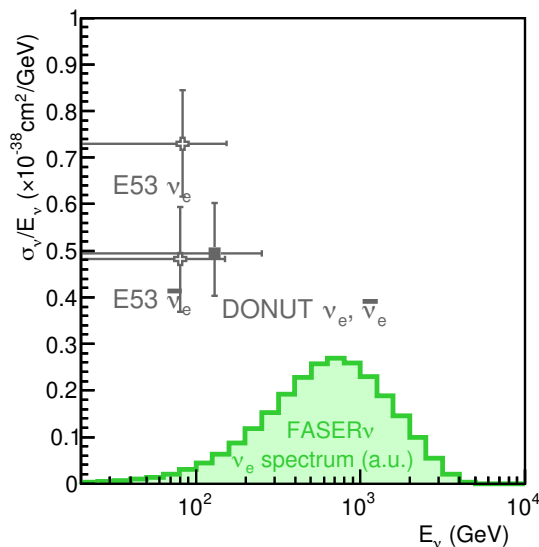

NEUTRINO MEASUREMENTS IN FASER

A huge number of neutrinos produced in the LHC collisions (hadron decay) traverse the FASER location covering an unexplored neutrino energy regime.
 FASERnu is an emulsion/tungsten detector to be placed in front of the main FASER detector to detect neutrinos of all flavours.

Primary physics goal – cross section measurements at high energy.
 Projected results:

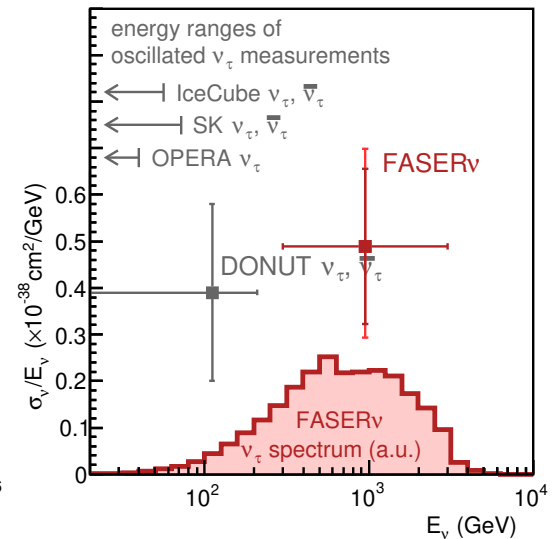
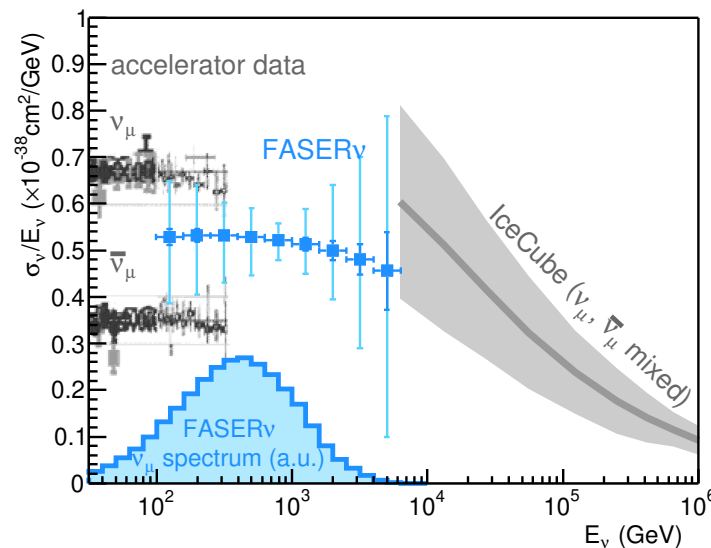
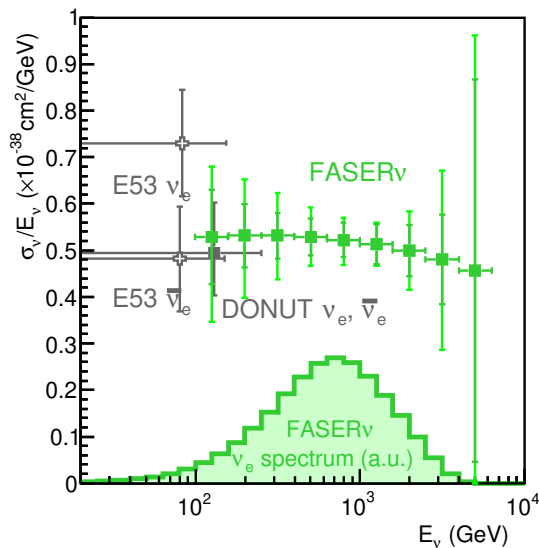

Uncertainty from neutrino production important

Neutrino energy reconstruction with resolution $\sim 30\%$ expected from simulation studies

EMULSION DETECTION

- Emulsion film made up of $\sim 80\mu\text{m}$ emulsion layer on either side of $200\mu\text{m}$ thick plastic
- Emulsion gel active unit silver bromide crystals (diameter 200nm)
- Charged particle ionization recorded and can be amplified and fixed by chemical development of film
- Track position resolution $\sim 50\text{nm}$, and angular resolution $\sim 0.35\text{mrad}$
 - But no time resolution!

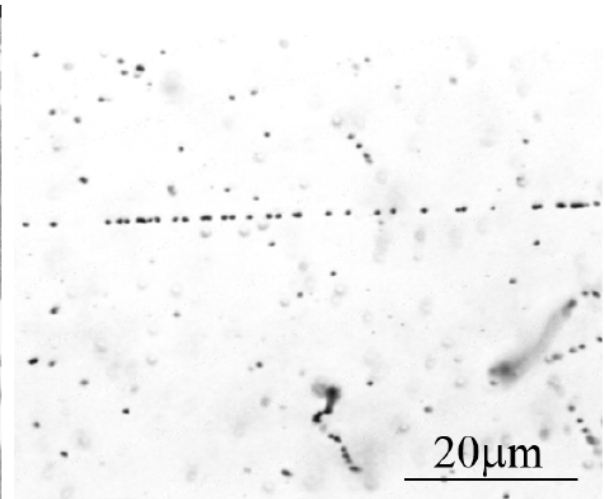
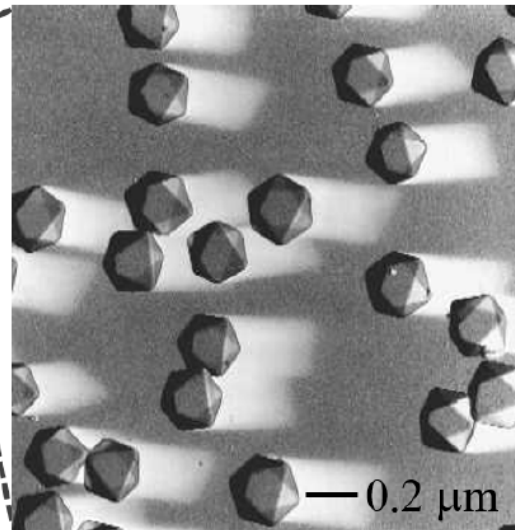
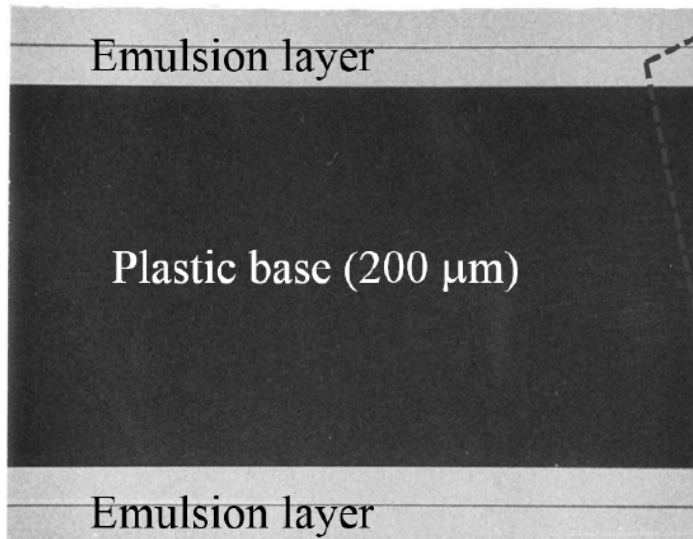
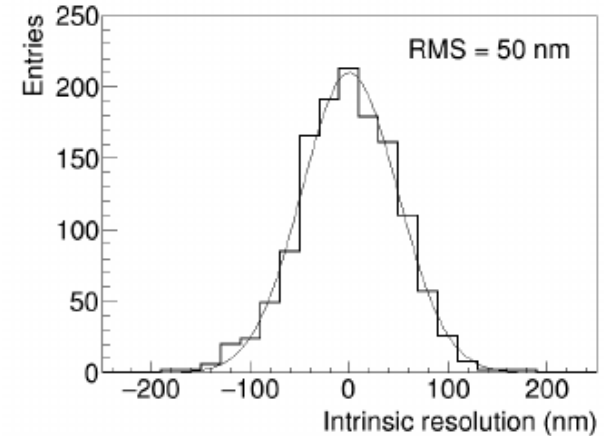

THE FASERnu DETECTOR

- FASERnu detector is 1.3m long, 25x25cm 1.2tn detector
- Made from 1000 x 1mm tick tungsten plates, interleaved with emulsion films
- Allows to distinguish all flavour of neutrino interactions and neutral hadron vertices
- Emulsion film has excellent position/angular resolution for charged particle tracks
- But no time resolution...
- Detector needs to be replaced every 30-50/fb to keep the track multiplicity manageable
- Will be replaced during Technical Stops during LHC running
 - Take advantage of transport infrastructure installed in UJ12/TI12 for FASER

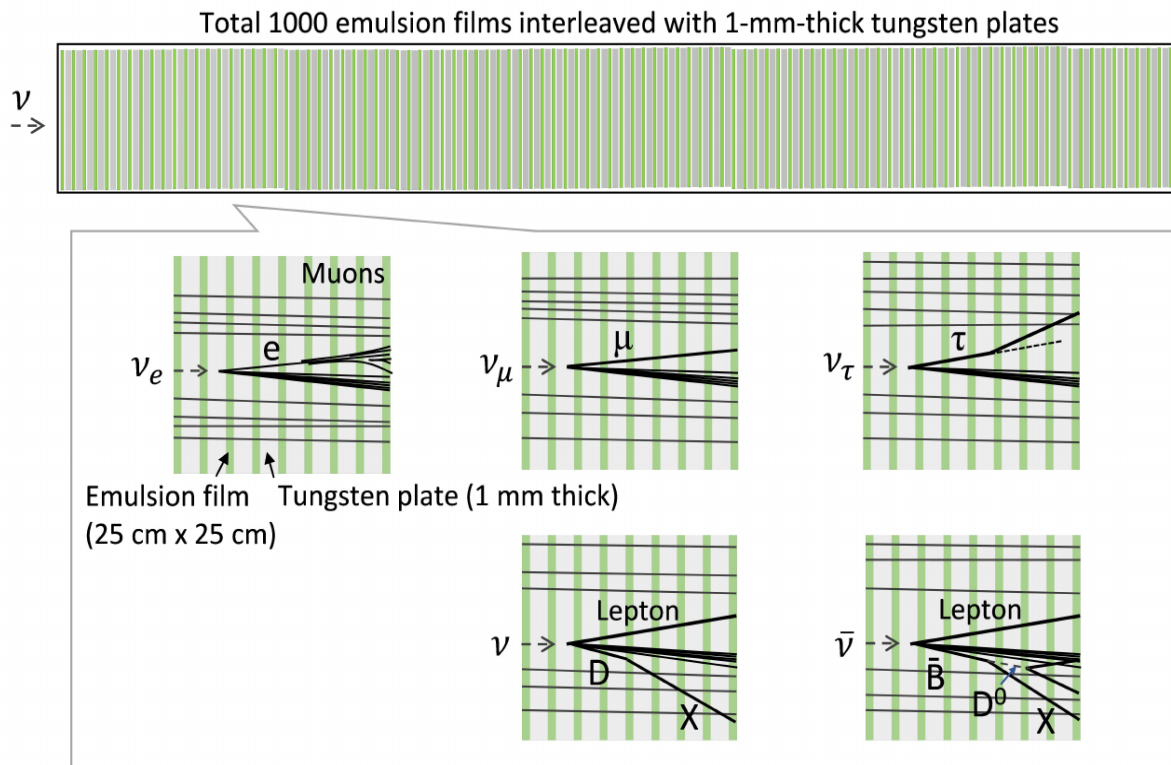

THE FASERnu DETECTOR

- FASERnu detector is 1.3m long, 25x25cm 1.2tn detector
- Made from 1000 x 1mm thick tungsten plates, interleaved with emulsion films
- Allows to distinguish all flavour of neutrino interactions and neutral hadron vertices
- Emulsion film has excellent position/angular resolution for charged particle tracks
- But no time resolution...
- Detector needs to be replaced every 30-50/fb to keep the track multiplicity manageable
- Will be replaced during Technical Stops during LHC running
 - Take advantage of transport infrastructure installed in UJ12/TI12 for FASER
- FASERnu will be centered on the LOS (in the FASER trench)
 - Maximises flux of all neutrino flavours

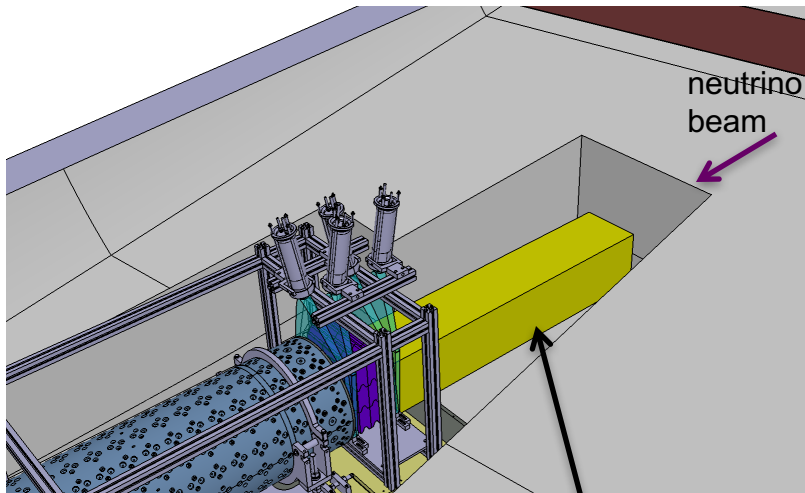

FASERnu

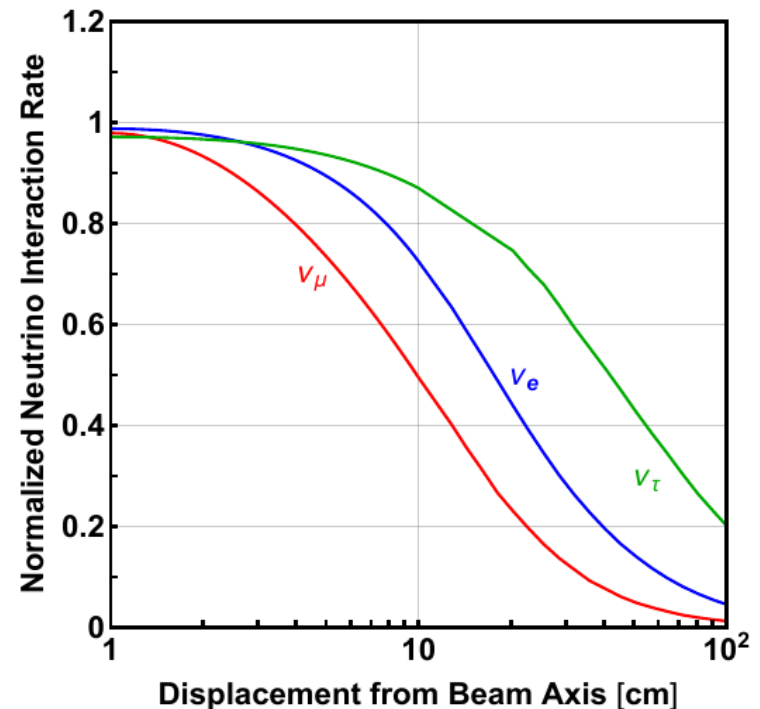

PILOT NEUTRINO DETECTOR

- A 30 kg emulsion detector was installed in T118 during 2018 running
 - Used to validate FLUKA simulation of background particle flux
- 12.5/fb data collected
 - ~30 neutrino interactions expected in detector
- Emulsion data developed, reconstructed and analysis ongoing
- Extremely valuable for validating the FASERnu concept, and optimizing the detector and reconstruction
- Several neutral vertices identified, likely to be neutrino interactions, but could also be neutral hadrons – analysis ongoing...

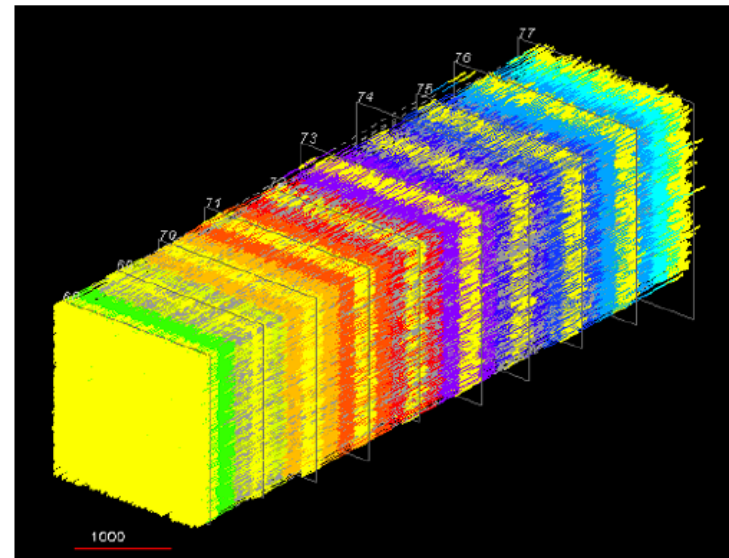

PILOT NEUTRINO DETECTOR

- A 30 kg emulsion detector was installed in T118 during 2018 running
 - Used to validate FLUKA simulation of background particle flux
- 12.5/fb data collected
 - ~30 neutrino interactions expected in detector
- Emulsion data developed, reconstructed and analysis ongoing
- Extremely valuable for validating the FASERnu concept, and optimizing the detector and reconstruction
- Several neutral vertices identified, likely to be neutrino interactions, but could also be neutral hadrons – analysis ongoing...

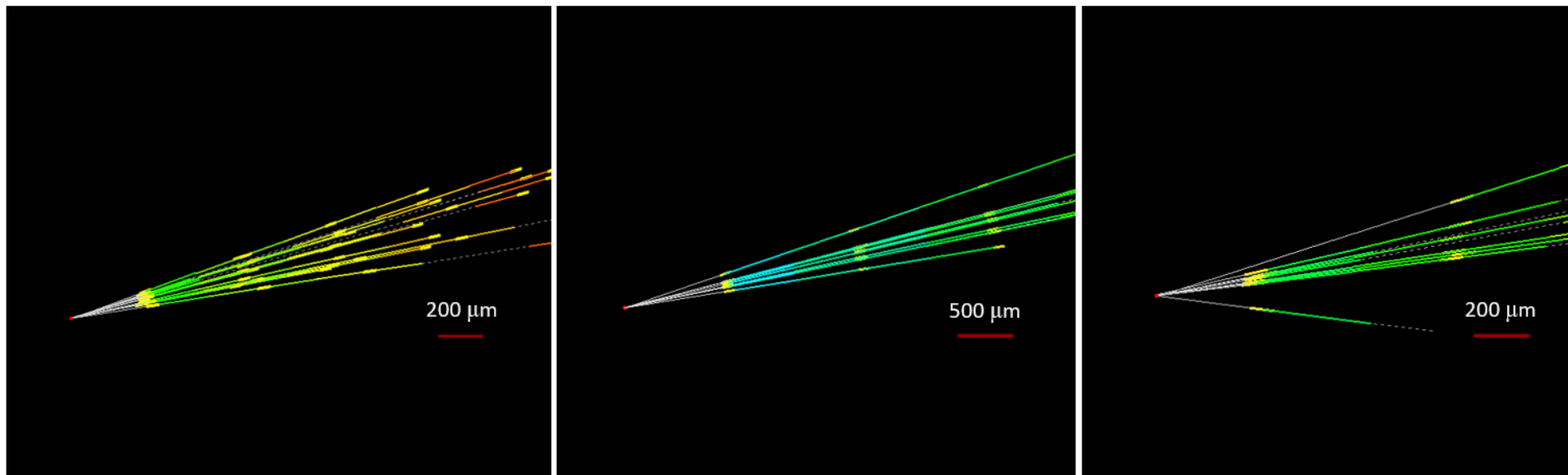

SUMMARY AND OUTLOOK

- FASER is a proposed small, fast and cheap experiment to be installed in the LHC during LS2, to take data in Run 3
 - Targeting light, weakly-coupled new particles at low p_T
 - FASERnu: first measurements of neutrinos produced at a collider and in an unexplored energy regime
- Detector designed to be affordable and fast to construct and install
 - Utilizing spare modules from existing experiments
 - Minimizing services needed where possible
 - Total detector cost <2MCHF
 - Host-Lab costs to be borne by CERN (civil engineering, transport, services)
- Detector design, construction and testing progressing well, and on track for LS2 installation
 - Effect of CERN shutdown on schedule needs to be understood (still hoping to install the detector in 2020)

SUMMARY AND OUTLOOK

- FASER is a proposed small, fast and cheap experiment to be installed in the LHC during LS2, to take data in Run 3
 - Targeting light, weakly-coupled new particles at low p_T
 - FASERnu: first measurements of neutrinos produced at a collider and in a detector
- Detector design, construction and testing progressing well, and on track for LS2 installation
 - Utilizing existing infrastructure
 - Minimizing impact on LHC
 - Total detector cost: ~100 M€
 - Host-Lab costs to be borne by CERN (civil engineering, transport, services)
- Detector design, construction and testing progressing well, and on track for LS2 installation
 - Effect of CERN shutdown on schedule needs to be understood (still hoping to install the detector in 2020)

Many *thanks* to:

- Heising Simons Foundation
- Simons Foundation
- CERN

for invaluable support!

THE FASER COLLABORATION

The FASER Collaboration consists of
62 members from 20 institutions and 8 countries



<https://faser.web.cern.ch/>

ACKNOWLEDGEMENTS

The FASER Collaboration gratefully acknowledges the contributions of many people

We are grateful to the ATLAS SCT project and the LHCb Calorimeter project for letting us use spare modules as part of the FASER experiment. In addition, FASER gratefully acknowledges invaluable assistance from many people, including the CERN Physics Beyond Colliders study group; the LHC Tunnel Region Experiment (TREX) working group; Rhodri Jones, James Storey, Swann Levasseur, Christos Zamantzas, Tom Levens, Enrico Bravin (beam instrumentation); Dominique Missiaen, Pierre Valentin, Tobias Dobers (survey); Jonathan Gall, John Osborne (civil engineering); Caterina Bertone, Serge Pelletier, Frederic Delsaux (transport); Francesco Cerutti, Marta Sabaté-Gilarte, Andrea Tsinganis (FLUKA simulation and background characterization); Pierre Thonet, Attilio Milanese, Davide Tommasini, Luca Bottura (magnets); Burkhard Schmitt, Christian Joram, Raphael Dumps, Sune Jacobsen (scintillators); Dave Robinson, Steve McMahon (ATLAS SCT); Yuri Guz (LHCb calorimeters); Salvatore Danzeca (Radiation Monitoring); Stephane Fartoukh, Jorg Wenninger (LHC optics), Michaela Schaumann (LHC vibrations); Marzia Bernardini, Anne-Laure Perrot, Katy Foraz, Thomas Otto, Markus Brugger (LHC access and schedule); Simon Marsh, Marco Andreini, Olga Beltramello (safety); Stephen Wotton, Floris Keizer (SCT QA system and SCT readout); Liam Dougherty (integration); Yannic Body, Olivier Crespo-Lopez (cooling/ventilation); Yann Maurer (power); Marc Collignon, Mohssen Souayah (networking); Gianluca Canale, Jeremy Blanc, Maria Papamichali (readout signals); Bernd Panzer-Steindel (computing infrastructure); and Mike Lamont, Fido Dittus, Andreas Hoecker, Andy Lankford, Ludovico Pontecorvo, Michel Raymond, Christoph Rembser, Stefan Schlenker (useful discussions).

BACK UP



$\sigma_{\text{mb}} \Rightarrow N \sim \theta(10^{17})$
 $\sim \lambda_{\text{deco}} / E \sim \frac{250 \text{ meV}}{1 \text{ TeV}} \sim \text{mrad}$
 $\Delta \Omega = \text{mrad} \times 2\pi$

$\sigma_{\text{heavy}} \sim \text{fb-pb} \Rightarrow N \sim \theta(10^{3-6})$
 $\Delta \Omega = 4\pi$

$PP \rightarrow A' X$
 \downarrow
 100 m
 $e^+ e^-$
 $M^+ M^-$

$M_{A'} \in [\text{MeV}, \text{GeV}]$
 $\epsilon \in [10^{-6}, 10^{-3}]$

TIMELINE

Global timeline



MORE INFORMATION...

FASER	LOI	1811.10243	
	TP	1812.09139	
	Physics Summary	1811.12522	Phys. Rev. D 99, 095011
FASERnu	LOI	1908.02310	EPJC 80 61 (2020)
	TP	2001.03073	

EFFECT OF LHC CROSSING ANGLE

- To avoid parasitic collisions and beam-beam effects in the common beampipe close to the IP, the LHC runs with a crossing-angle
 - The half crossing angle is $\sim 150\mu\text{rad}$, which moves the collision axis by $\sim 7.5\text{cm}$ at the FASER location
 - Such a change reduces the signal acceptance in FASER by $\sim 25\%$
 - Leads to very small changes in physics sensitivity

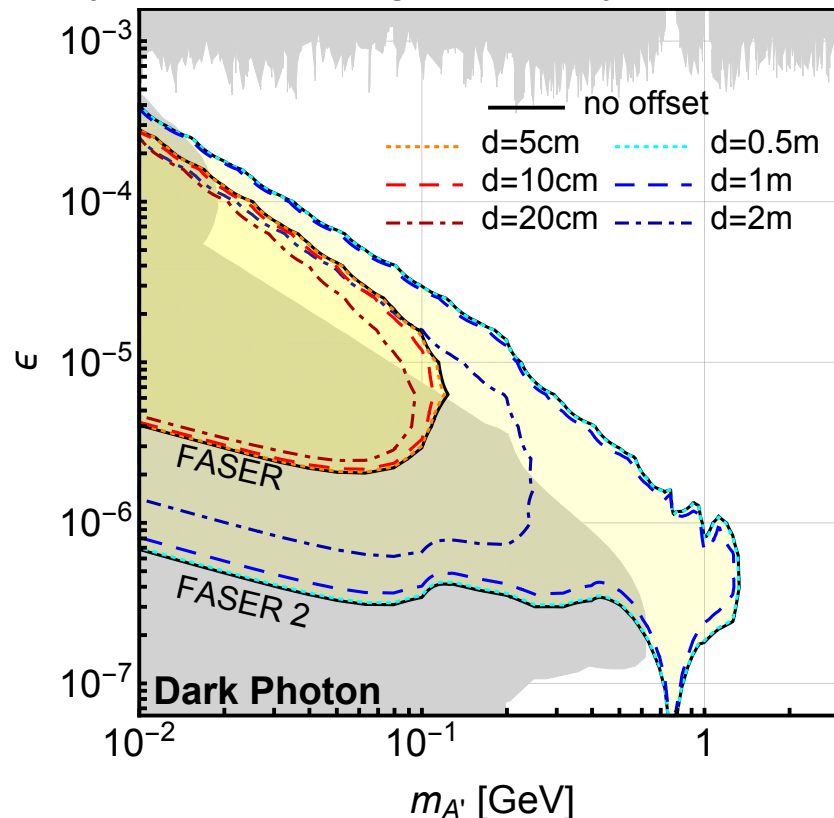

Tracker alignment issues

Momentum resolution will be limited by the relative alignment of the 3 tracking stations in the bending plane.

Significant rate of muons going through FASER tracker, but since we don't know their momentum they can not be used to constrain this alignment (no standard candles (Z, J/psi etc..) in FASER.

Since we use a permanent magnet we cannot use the trick (used in ATLAS MS) of taking straight track data with the field off to constrain the alignment.

A 100um precision of the relative position of the tracking stations in the bending plane, leads to 100% uncertainty on the momentum for track momenta above ~650 GeV.

For FASER physics good track momentum resolution not needed, but of course for many reasons (background measurements, auxiliary physics measurements etc..) we want as good resolution as possible.

OTHER PRODUCTION MECHANISMS

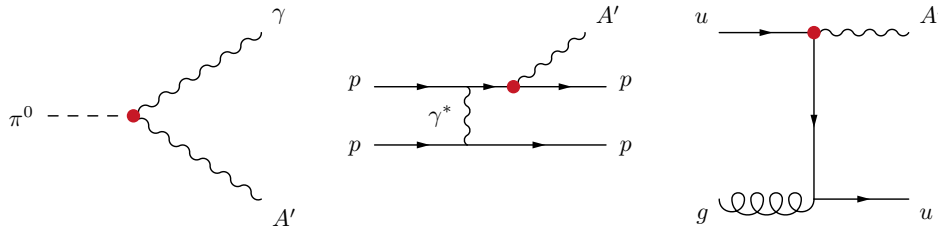

- Consider π^0 decay, η decay, dark bremsstrahlung
- Results for 1st model point: $(m_{A'}, \epsilon) \equiv (20 \text{ MeV}, 10^{-4})$

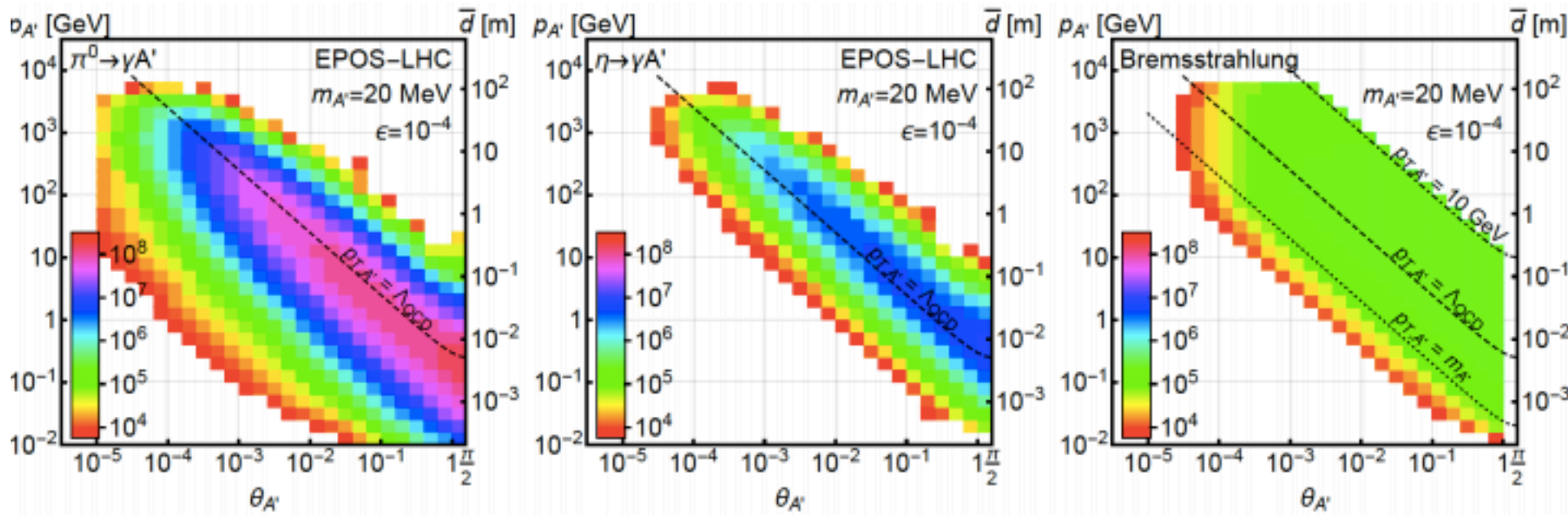

- From $\pi^0 \rightarrow \gamma A'$, $E_{A'} \sim E_{\pi} / 2$ (no surprise)
- But note rates: even after ϵ^2 suppression, $N_{A'} \sim 10^8$;

ANOTHER EXAMPLE: Axion-Like-Particles (ALPs)

ALP production using the LHC as a beam-dump experiment. Very high energy photons produced in LHC collisions, interacting with material in the **TAN** can produce ALPs. The ALPs (with \sim TeV energy) then propagate in a straight line, and can decay inside FASER (480-140 = 340m from their production point).

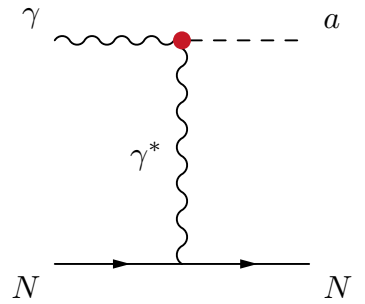

ALP production via the Primakoff process from photons scattering in the TAN

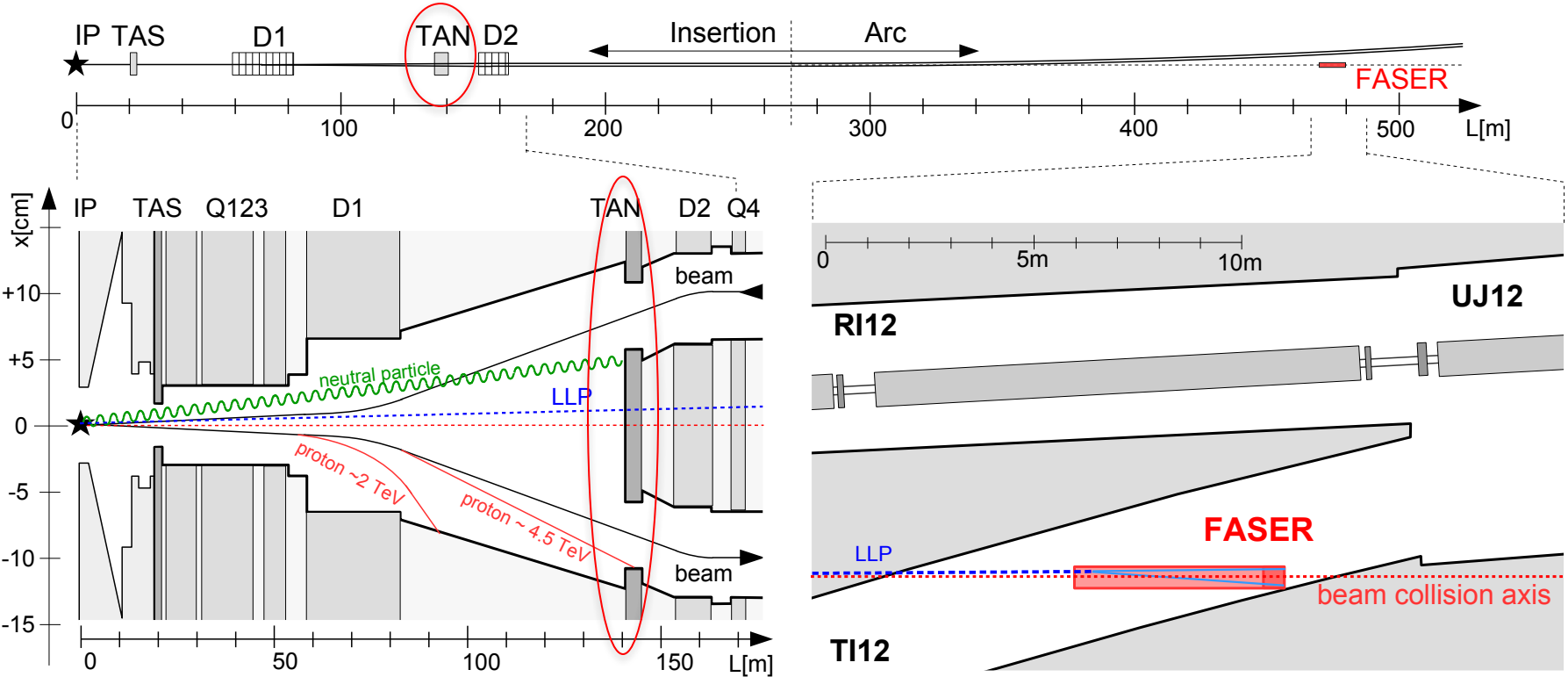

ANOTHER EXAMPLE: Axion-Like-Particles (ALPs)

ALP production using the LHC as a beam-dump experiment. Very high energy photons produced in LHC collisions, interacting with material in the **TAN** can produce ALPs. The ALPs (with \sim TeV energy) then propagate in a straight line, and can decay inside FASER (480-140 = 340m from their production point).

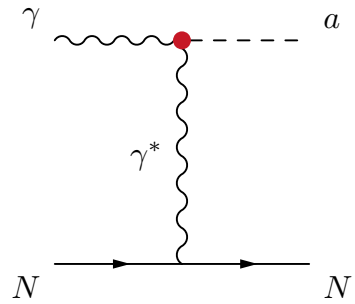

ALP production via the Primakoff process from photons scattering in the TAN

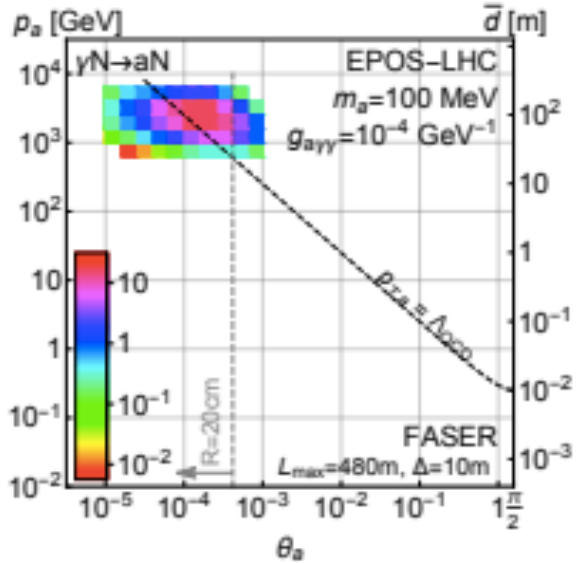
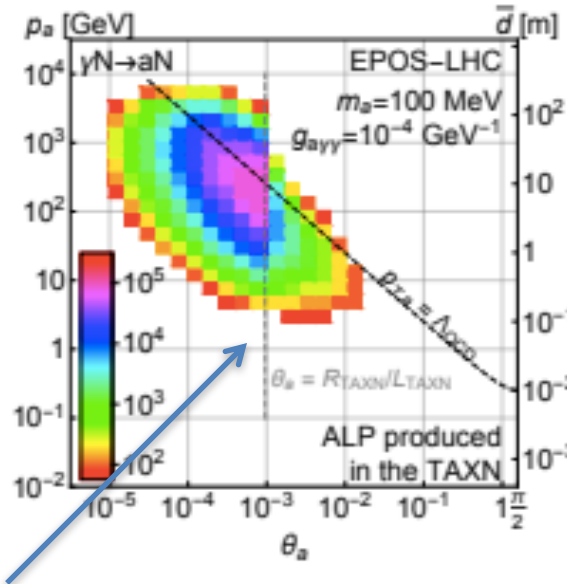
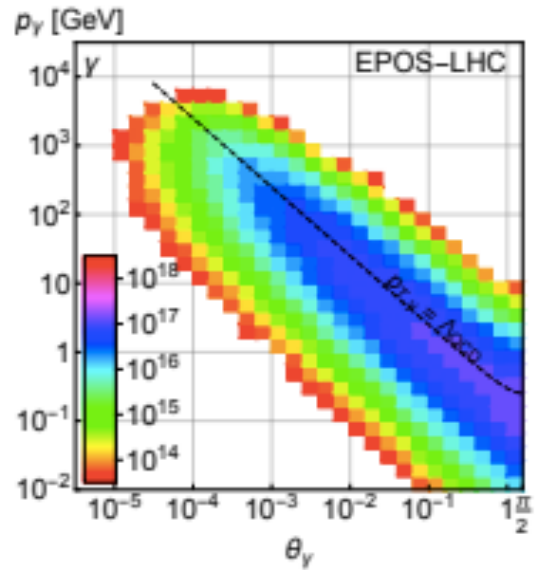

Assuming angular coverage of TAN is < 1 mrad

note this old plots, and FASER volume $R=10$ cm and decay length 1.5m now! 63

EXPECTED PERFORMANCE – 2 photon signature

- For ALP- $\rightarrow\gamma\gamma$ decay, magnetic field does not help separate closely spaced decay products
- We investigated calorimeter / pre-shower to allow to be able to resolve closely spaced (~ 1 mm) high energy photons (>500 GeV) - seems very challenging

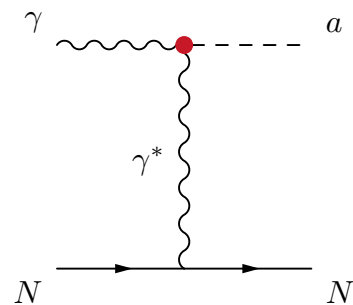
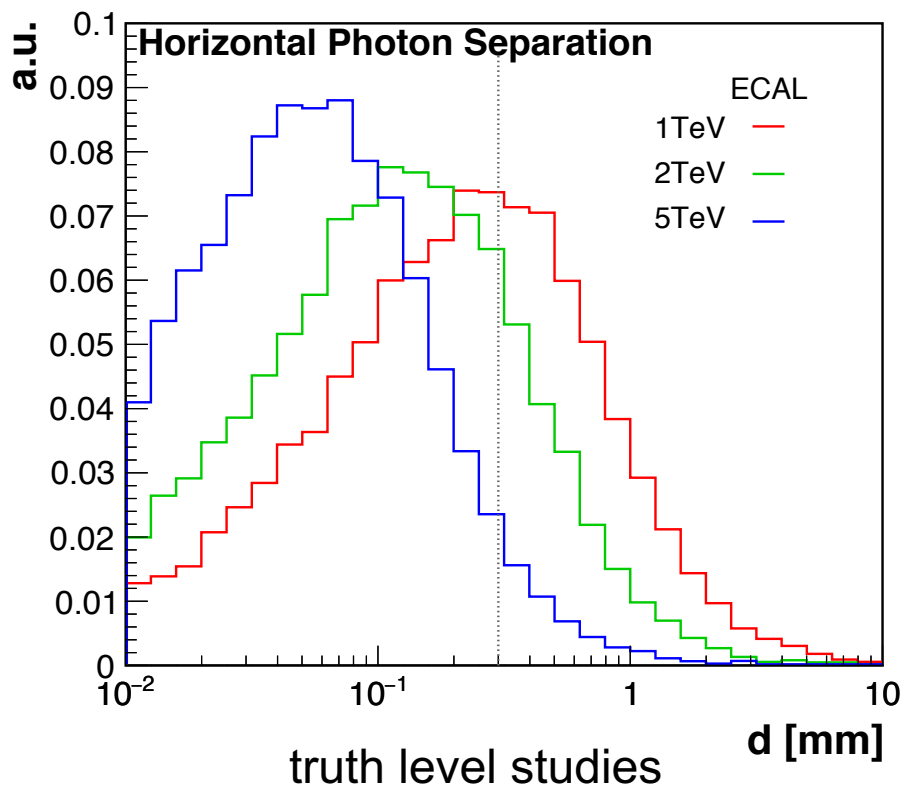

ALP production via the Primakoff process from photons scattering in the LHC infrastructure material (TAN)

EXPECTED PERFORMANCE – 2 photon signature

- For ALP- $\rightarrow\gamma\gamma$ decay, magnetic field does not help separate closely spaced decay products
- We investigated calorimeter / pre-shower to allow to be able to resolve closely spaced ($\sim 1\text{mm}$) high energy photons ($>500\text{ GeV}$) - seems very challenging

Preliminary studies suggest that events with no tracks and a large amount of EM energy in the calorimeter would be \sim background free \Rightarrow an ALP signal would be detectable without the need to resolve the 2 photons.

Further studies show an interesting background would be high energy neutrino's interacting in the calorimeter to give large EM showers

- either muon neutrinos leading to hadronic showers with π^0 ,
- or (more rarely) electron neutrinos interacting to give electrons

First time I have heard of neutrino interactions in the detector being a background for a collider search!

We are considering to have a scintillator pre-shower to give a small amount of longitudinal information which could be used to veto such neutrino interaction events.

In longer term investigating installing a fine granularity silicon pre-shower to be able to separate close-by photons.

AXION LIKE PARTICLES (ALPs)

- Assuming background free single-photon like search for ALPs sensitivity for 10/fb and 150/fb

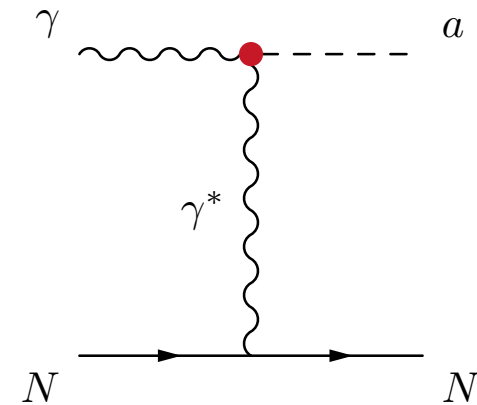
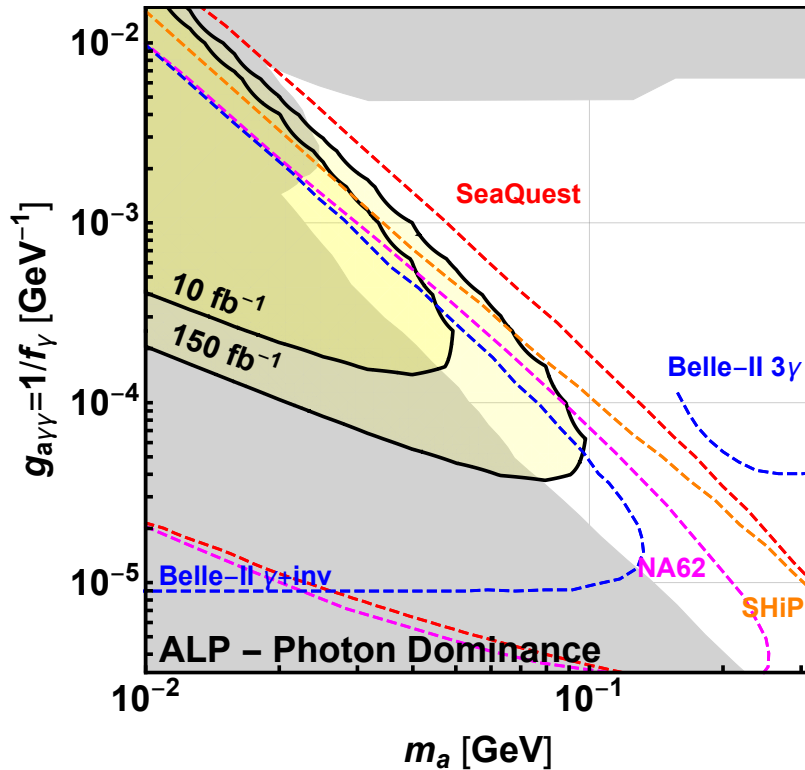

Dipole Assembly

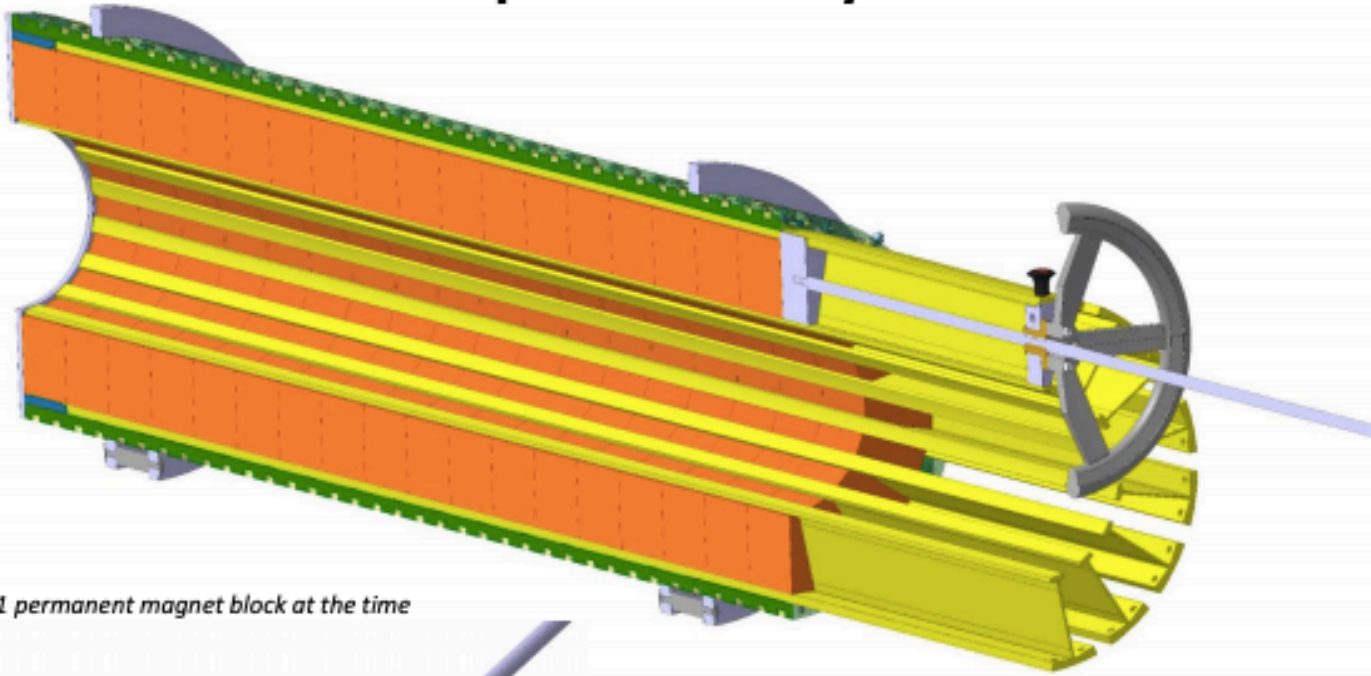

Pictured: pushing of 1 permanent magnet block at the time

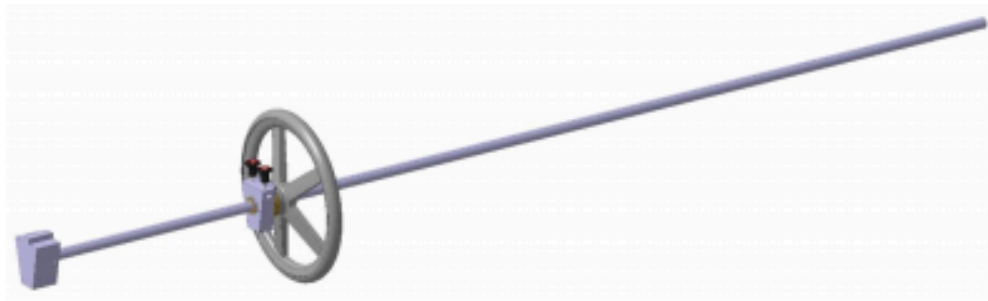
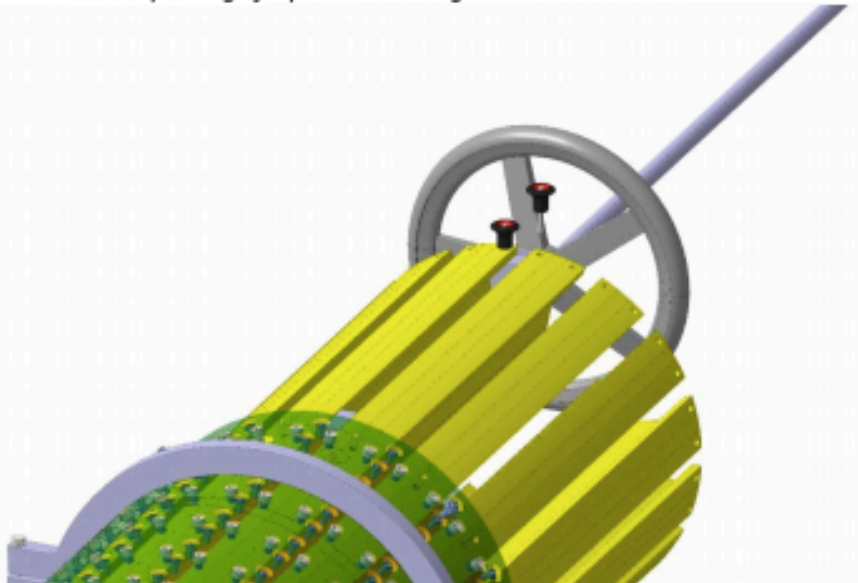

Pictured: a very simple assembly tooling

STRAY MAGNETIC FIELD

- More detailed calculation of stray field, also going to larger distance
 - 3mT limit (for signage at CERN) always within 50cm of magnet centre (so enclosed in trench, does not impact access)

$x=0\text{mm}, y=0\text{mm}$

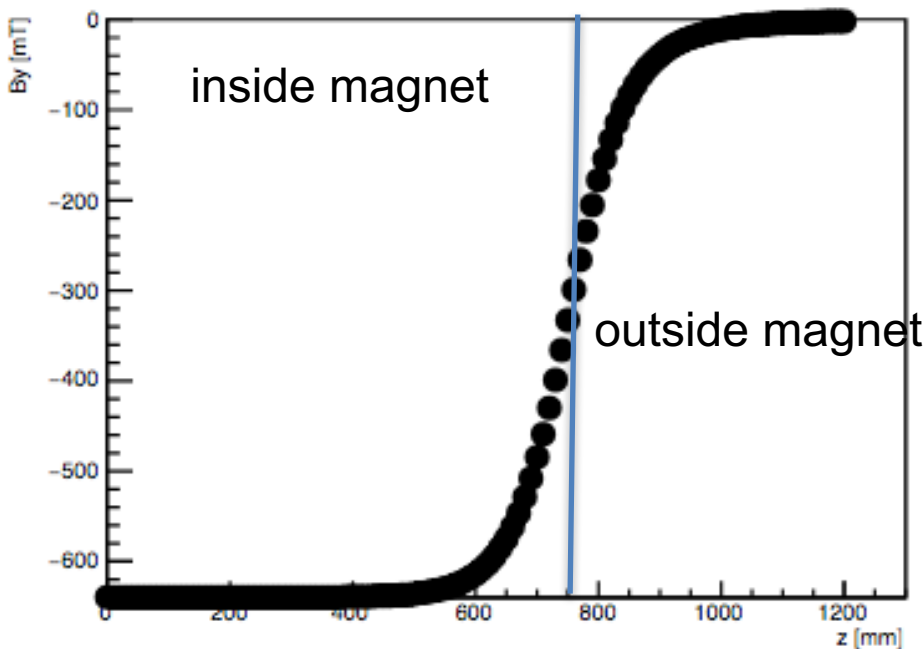

5cm outside magnet opening

B [mT] at $z=800$ mm

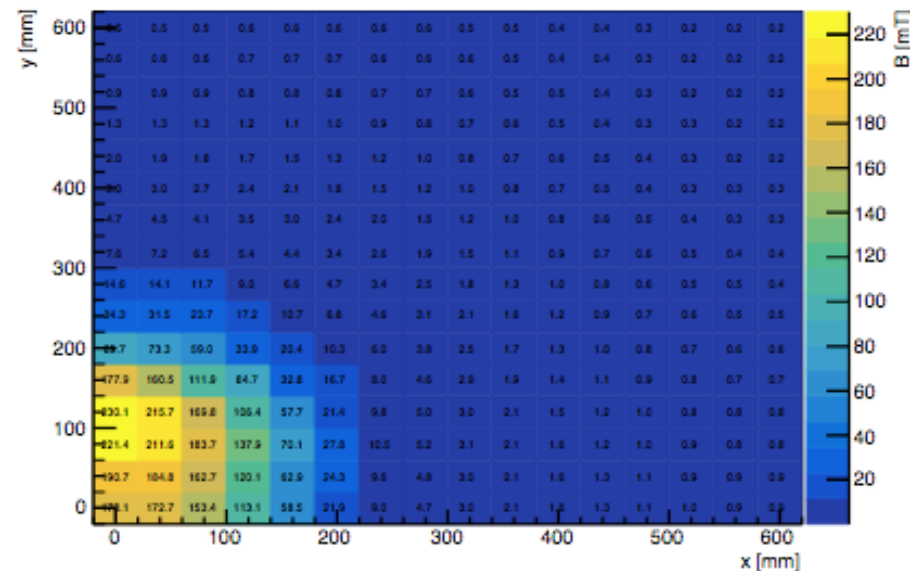

1mT field 50cm from magnet centre

The Barrel Module

- 2112 Identical **Barrel Modules** required for SCT mounted on **4 Barrels** (B3, B4, B5, B6)

4 single-sided *p-in-n* ac-coupled **silicon microstrip sensors**, 80 μm pitch, mounted back-to-back, 40 mrad stereo rotation angle

12 128-channel **ABCD3TA** binary readout ASICs

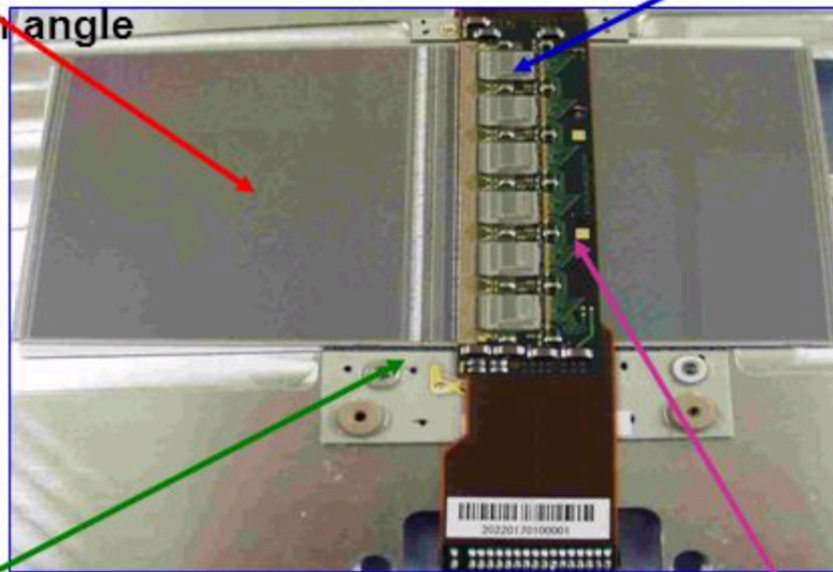

Thermo-mechanical baseboard - encapsulated thermalised pyrolitic graphite with fused **BeO** facings

Bridged wrap-around hybrid – copper-polyimide flex glued on carbon-carbon substrate

FASER TRACKER: COOLING

- Due to the low radiation in T112 the silicon can be operated at room temperature, but the detector needs to be cooled to remove heat from the on-detector ASICs
 - ~5W per module => 40W/plane => 360W in full detector
- Tracking layer designed to give sufficient thermal and mechanical properties, whilst minimizing material in tracking volume
- Use simple water chiller with inlet temperature 10-15 degrees
 - Tracking stations flushed with dry air to avoid condensation
 - Hardware interlock to turn off tracker if cooling / humidity control fails



SMC chiller

Tracking layer frame, CNC machined from single Al block. Frame contains 5mm cooling pipe running around the outside.

Thermal performance validated by FEA simulations and measurements (NTC on each SCT module, and 2 on frame)

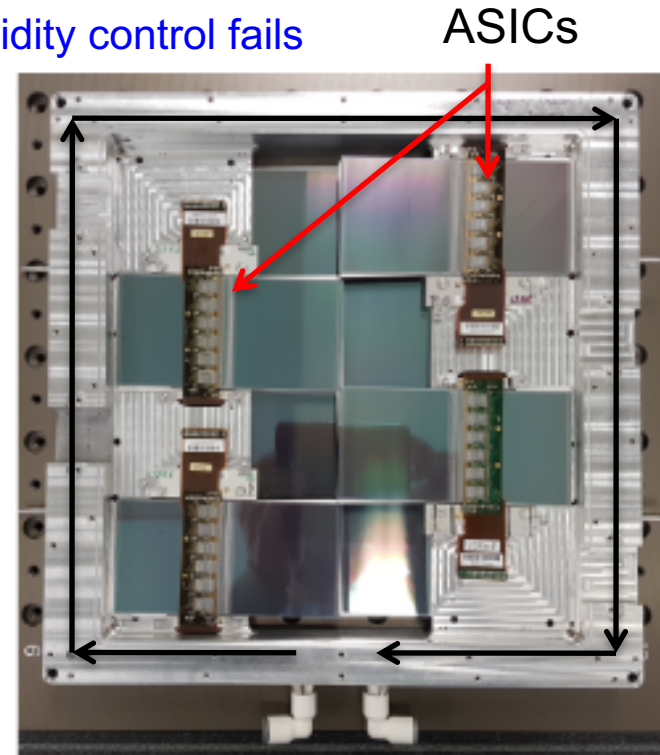

FASER TRACKER: COOLING

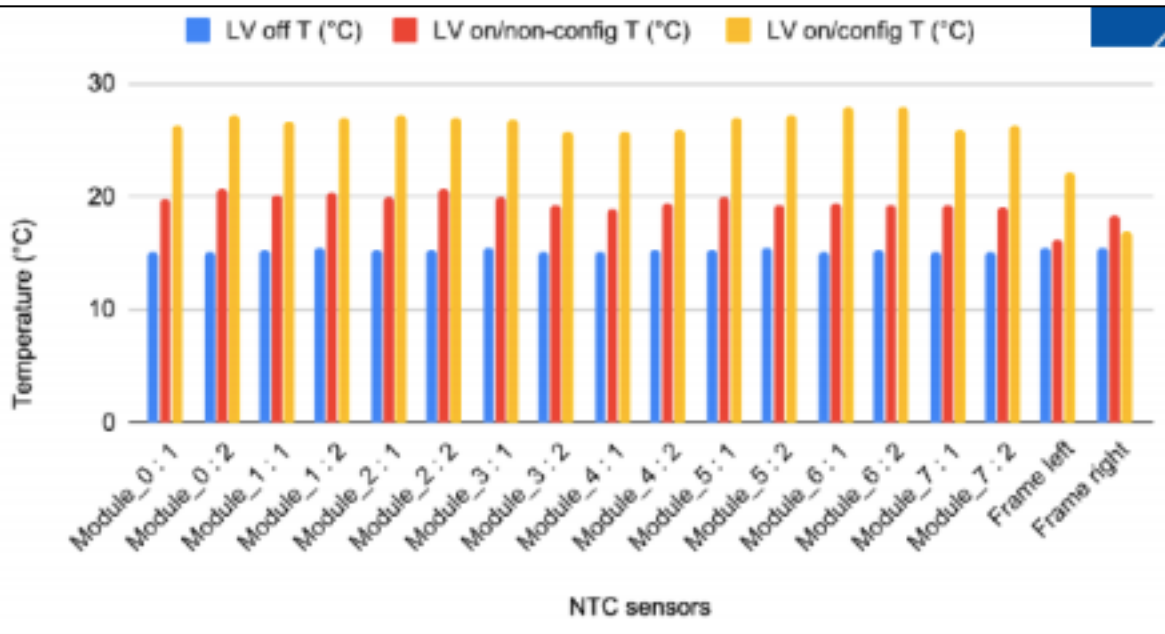

operated at room temperature,
 t from the on-detector ASICs

ector

and mechanical properties, whilst

15 degrees

ensation

umidity control fails

ASICs



SMC chiller

Tracking layer frame, CNC machined from single Al block. Frame contains 5mm cooling pipe running around the outside.

Thermal performance validated by FEA simulations and measurements (NTC on each SCT module, and 2 on frame)

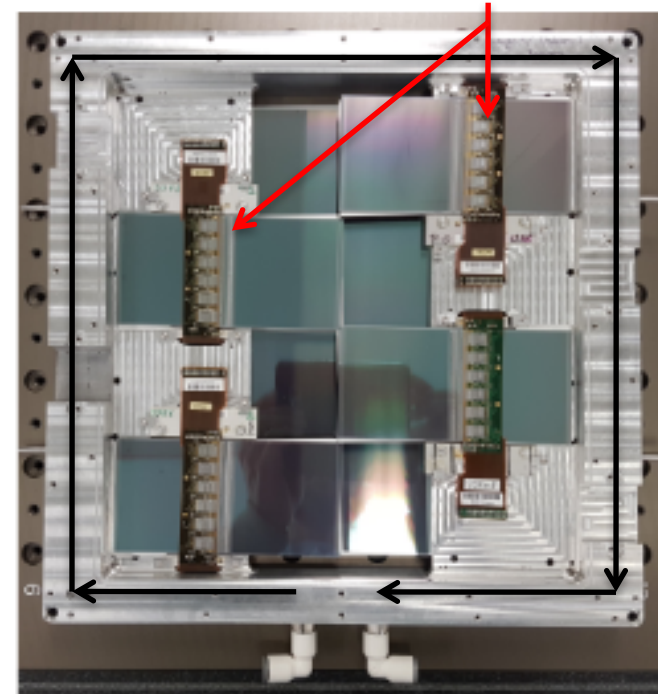

FASER TRACKER: READOUT

Decided to not use the ATLAS SCT readout to simplify the system.
Custom made flex cable used to connect pigtail on SCT module to custom PCB patch panel which separates out power (HV, LV), readout, monitoring lines.

- 3m-long Twinax cables used to send data from patch- panel to Tracker Readout Board (TRB)
- TRB is General Purpose FPGA board developed in University of Geneva for other experiments – with dedicated adapter card to handle connections
- 1 TRB / tracker plane (9 in full detector)
- TRB logic implemented in firmware:
 - Simple DAQ functionality (error checking, header etc...)
 - Data send via ethernet to DAQ PCs on surface (600m from FASER)

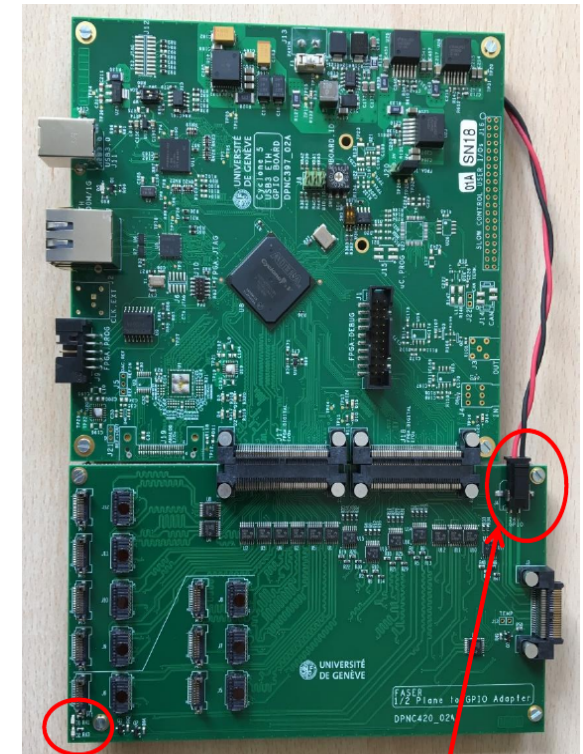
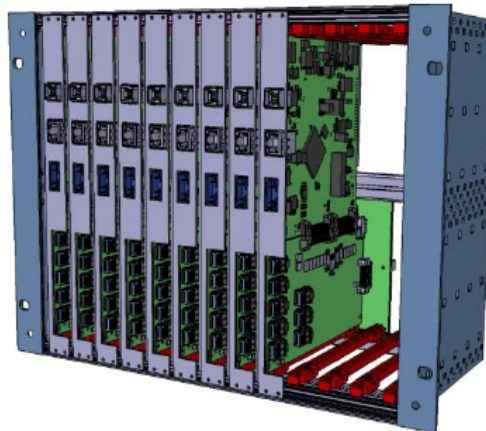

2 front panels LEDs

24V discrete wire to TRB adapter

Tracker Readout Board

FASER TRACKER: POWERING

Power requirements of Tracker are:

Parameter	Channels	Voltage [V]			Current [A]	
		Min.	Typ.	Max.	Typ.	Max.
Tracker Analog (Vcc)	72	0	3.5	5.1	0.9	1.3
Tracker Digital (Vdd)	72	0	3.5	5.1	0.57	1.3
Tracker Bias (Vbias)	72	0	150	500	0.3×10^{-6}	5×10^{-3}

Chosen solution Wiener MPOD Power Supplies (ISEG cards for HV).

In order to save money split HV such that 1 channel serves 4 modules. 18 MPV 8008I LV cards serve 72 SCT modules in the system.

Only 3 ISEG EHS 8405p HV cards needed.

Radiation level in TI12 measured to be very low for LHC environment, still higher than on surface.

To avoid problems from SEU in PS we have implemented a HW protection circuit on the LV, where any over voltage will be cut by dedicated circuit.

Cables constructed by CERN EP-DT (many thanks)



FASER TRACKER: COMMISSIONING EXAMPLES

Noise versus channel:

ThresholdScan [module=2, link=0]

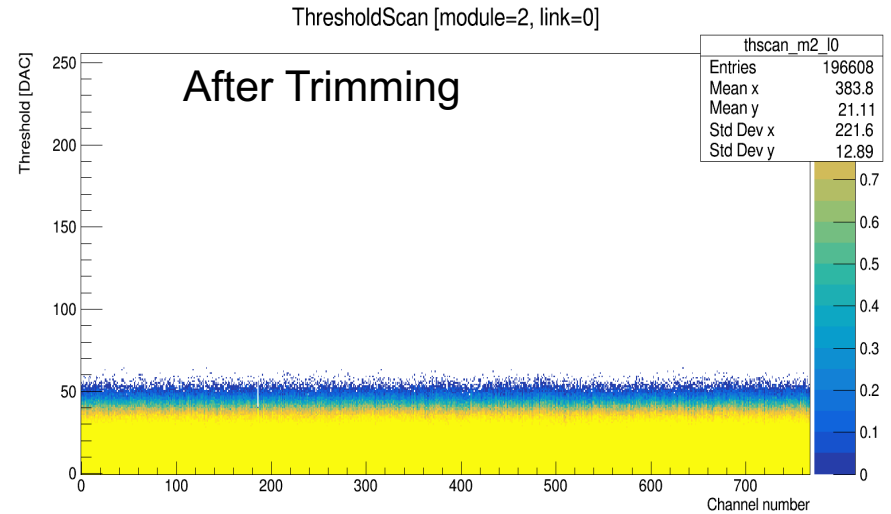
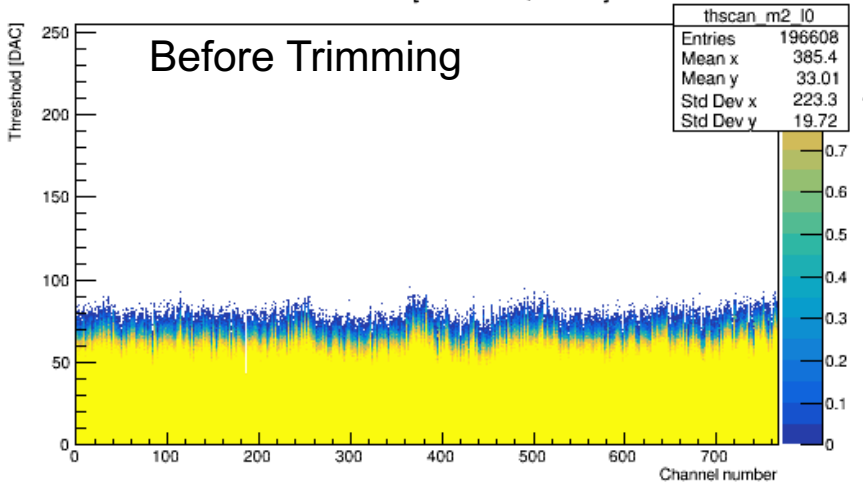

Basic setup and Full setup ENC

● Basic setup ● Full setup ● Cambridge setup

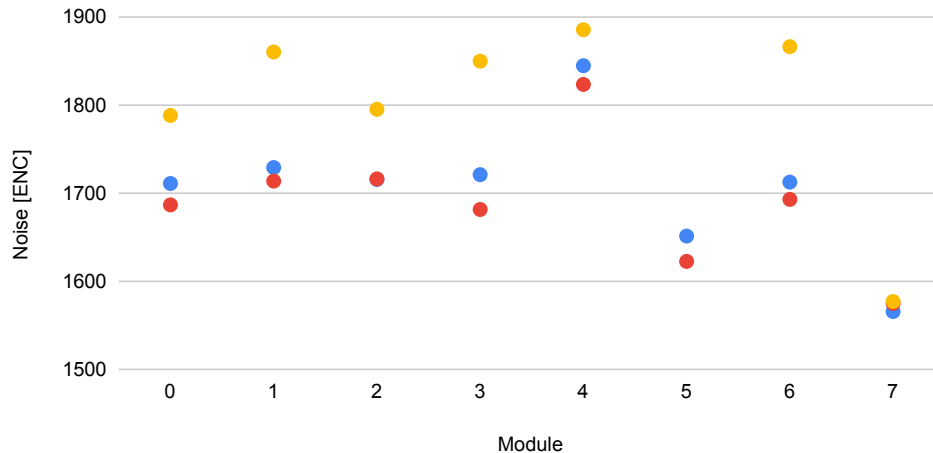

Comparison of noise in single module QA setup and final setup

IV scan ramp up/down - Module 0

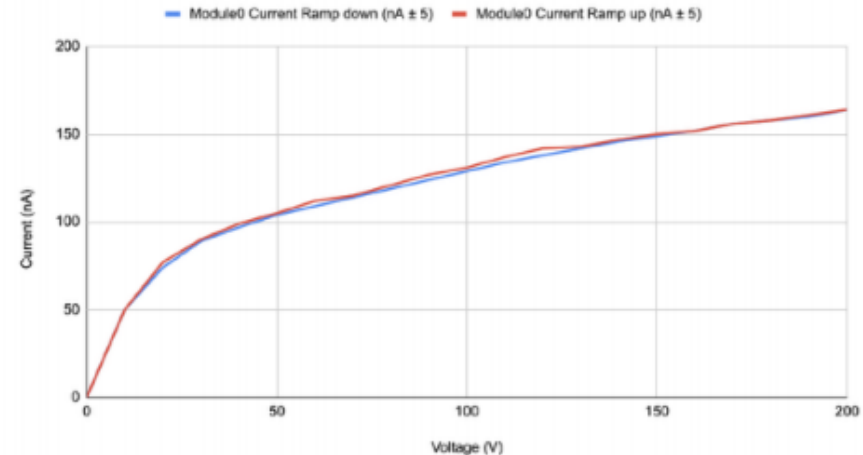

IV curve in final setup

FASER TRACKER: CURRENT STATUS

- 1st prototype plane produced and assembled Sept. 2019
 - Used for extensive testing since then
- 2nd prototype produced January 2020
 - Small updates in design based on 1st prototype
 - Design validated with many tests
- Production of final tracker frames ongoing at University of Geneva
- All other needed components produced and available
- Assembly and metrology procedure well defined
- Validation procedure for each layer well defined and exercised on prototype planes
- All infrastructure for testing and validation of tracker setup in our labs at CERN
- Waiting for CERN to re-open...

CALORIMETER - PMTs

R7899-20 Hamamatsu PMTs provided by LHCb

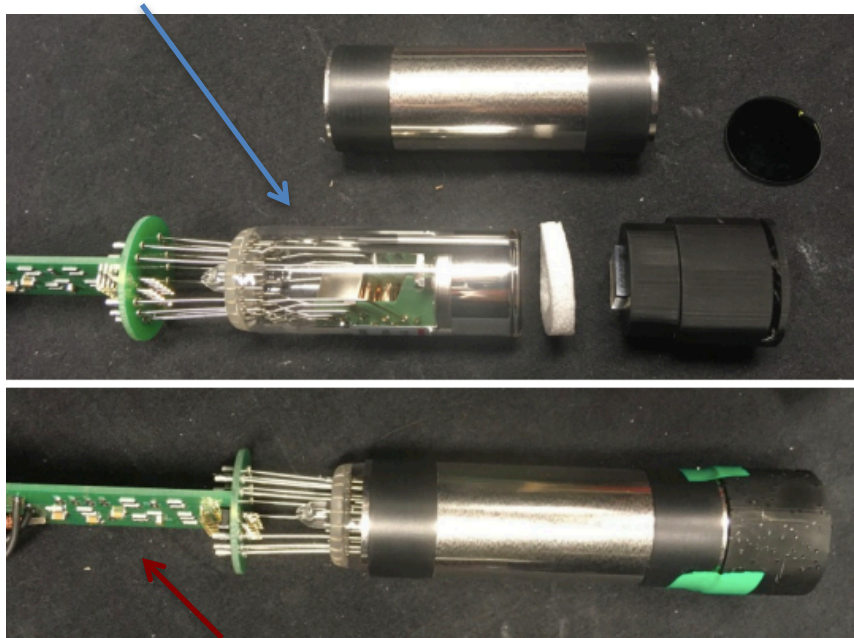

New HV divider

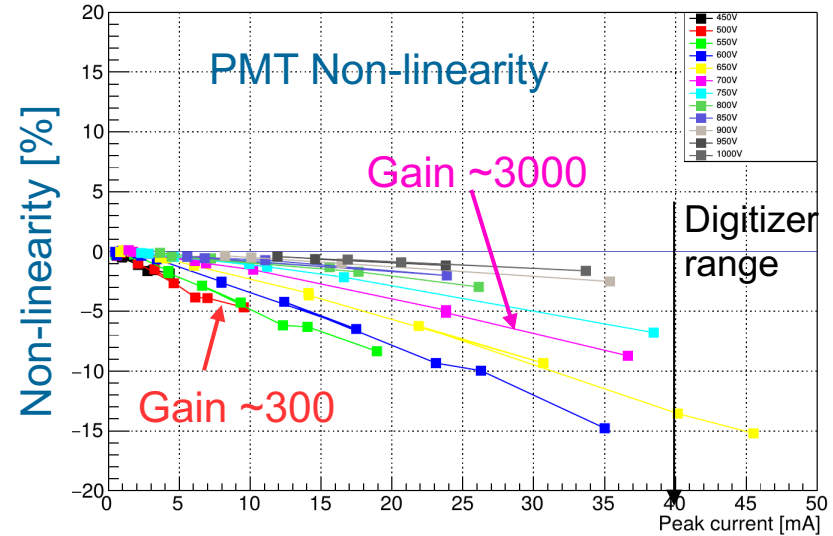

- Testing lab with LED pulser and cosmic ray test stand setup at CERN
- Used to characterize and determine HV working point
- Low gain needed to have sufficient range for largest signals
- Energy calibration:
 - Using *in situ* muons (MIPs)
 - Plan to also have test-beam during Run-3 for spare modules

SCINTILLATOR SYSTEM

Scintillators used for:

- Vetoing incoming charged particles
 - Very high efficiency needed ($O(10^8)$ incoming muons in 150/fb)
- Triggering
- Timing measurement
 - ~1ns resolution
- Simple pre-shower for Calorimeter

Design:

- EJ-200 plastic scintillator from ELJEN Technology
- Most scintillators 20x300x300mm – gives ~200 photo-electrons/MIP
- Timing station uses different design to improve time resolution
 - two 10x200x400mm – gives ~80 photo-electrons/MIP
- All use Hamamatsu H6410 PMT
 - Large diameter (46mm)
 - Large gain ($10^6 - 10^8$)
- Scintillators, light-guides and PMT holders designed and manufactured at CERN

Hamamatsu H6410 PMT



CALORIMETER/SCINTILLATORS – POWER/READOUT

The calorimeter and Scintillators use a common power and readout.

The PMT HV needs are:

Parameter	Channels	Voltage [V]			Current [A]	
		Min.	Typ.	Max.	Typ.	Max.
Scintillator PMTs	10	500	2000	2700	10^{-8}	0.67×10^{-3}
Calorimeter PMTs	4	400	800	1500	10^{-8}	0.1×10^{-3}

PMT HV is provided by 16 channel ISEG HV Module (EHS F030n) which is integrated into the MPOD system used for the Tracker powering.



The PMT signals are digitized by a CAEN vx1730 digitizer board:

- 16 channels
- 500 MHz sampling frequency
- 14-bit precision
- Provides 8 independent trigger outputs

DETECTOR SUPPORT

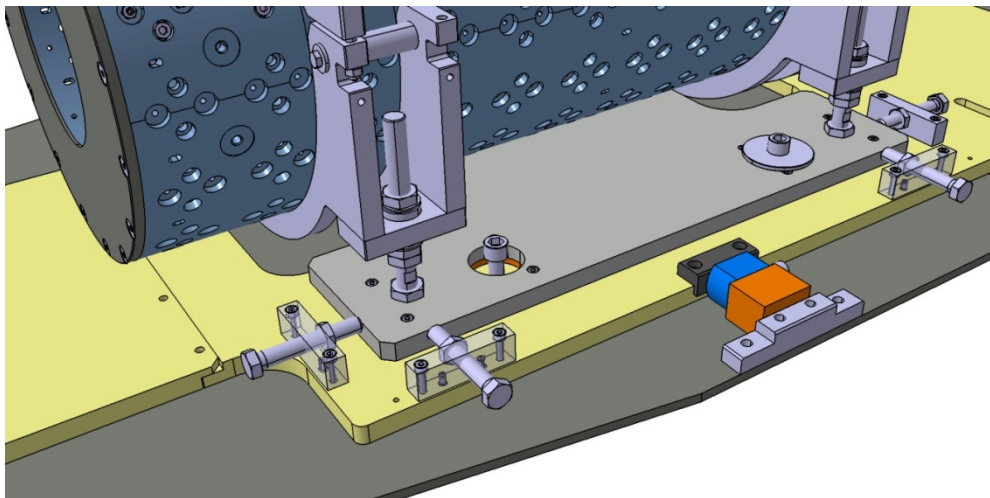
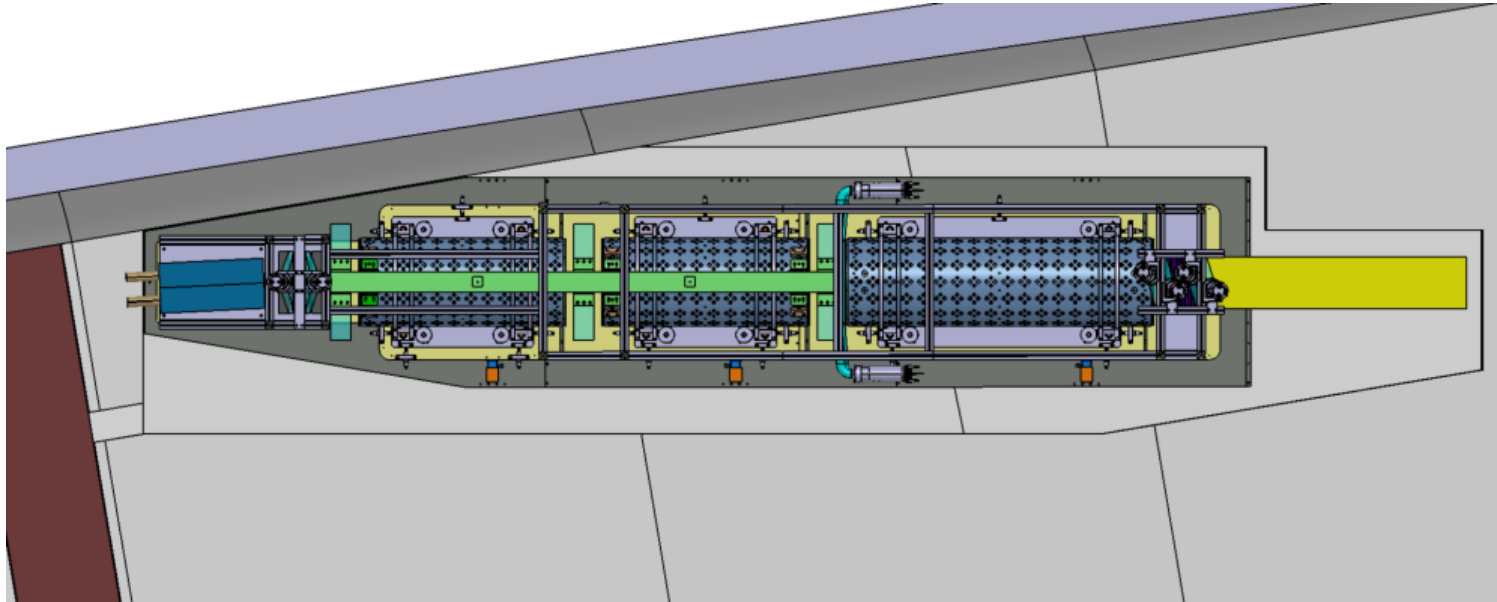

Magnet
support and
tuning system

DETECTOR SUPPORT – UPPER FRAME

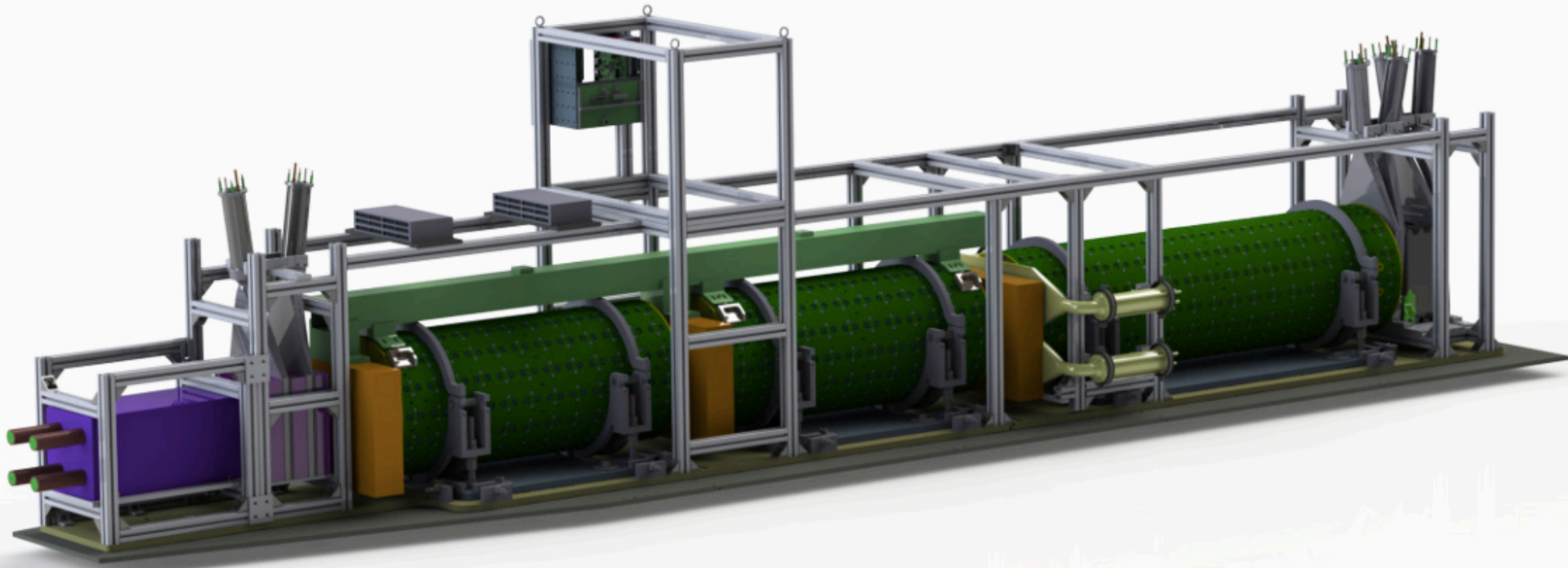

Upper frame to support:
Scintillators (including PMTs)
Calorimeter
On-detector cables and electronics

Constructed from 40 mm² aluminum profiles (Bosch profiles)
Easy to construct and flexible

COST ESTIMATES

FASER:

Detector component	Cost [kCHF]
Magnet	420
Tracker Mechanics	66
Tracker Services	105
Scintillator Trigger & Veto	52
Calorimeter	13
Support structure	60
Trigger & Data Acquisition	52
Total	768
Spares	56

Biggest single costs:
Magnet
Power Supplies (~100kCHF)

FASERnu:

Item	Cost [kCHF]
Emulsion gel for 440 m ²	315
Emulsion film production cost for 440 m ²	32
Tungsten plates, 1200 kg (first set)	173
Tungsten plates, 1200 kg (second set)	173
Packing materials	5
Support structure	12
Chemicals for emulsion development	20
Tools for emulsion development	5
Racks for emulsion film storage	5
Computing server	10
Total	750
[Emulsion gel for 2024 running]	[135]
[Additional consumables for 2024 running]	[23]
[Total including 2024 running]	[908]

Biggest single costs:
Tungsten plates (~350kCHF)
Emulsion Gel (~300kCHF)

THE TI12 TUNNEL



FASER is situated at the bottom of the TI12 tunnel close to the LHC.

TI12 was the old injection line for LEP, and is now unused.

TI12 slopes upwards, and the LOS emerges from the tunnel floor.

In order to install the FASER detector on the LOS a small amount of civil engineering work needs to be done, to lower the floor of the tunnel (50cm maximum).

After such digging a 5m long detector can be situated along the LOS.

FLUKA SIMULATIONS: MUON MAP

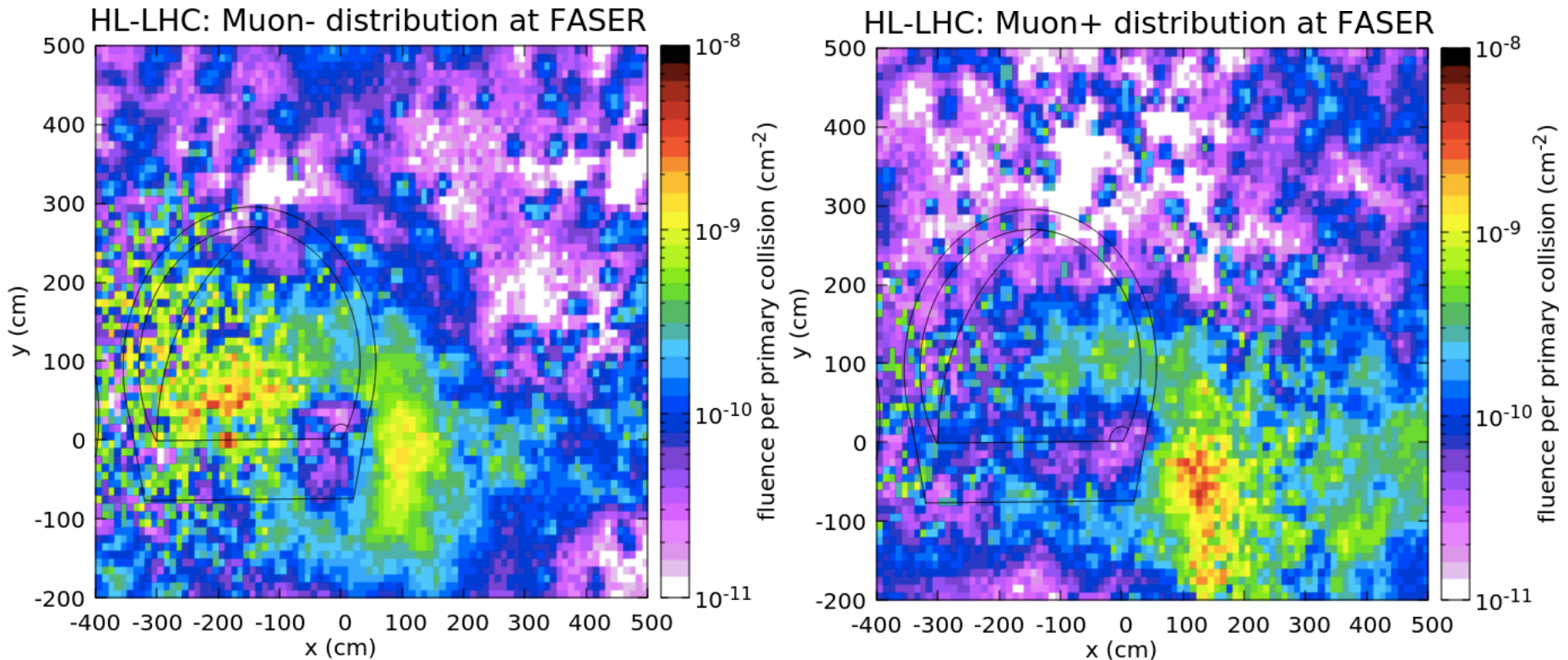

Due to bending from LHC magnets, muon flux on LOS is reduced:
 μ^- tend to be bent to the left, μ^+ to the right of FASER.

Energy threshold [GeV]	Charged particle flux [$\text{cm}^{-2} \text{s}^{-1}$]
10	0.40
100	0.20
1000	0.06

Expected charged particle rate for different energy thresholds ($2e34\text{cm}^{-2}\text{s}^{-1}$)

BEAM BACKGROUNDS

- Measurements using emulsion detectors installed in TI12 in 2018 running confirm expected particle flux
- Measurements using TimePix BLM in TI12 confirm that particle flux is correlated with luminosity in IP1

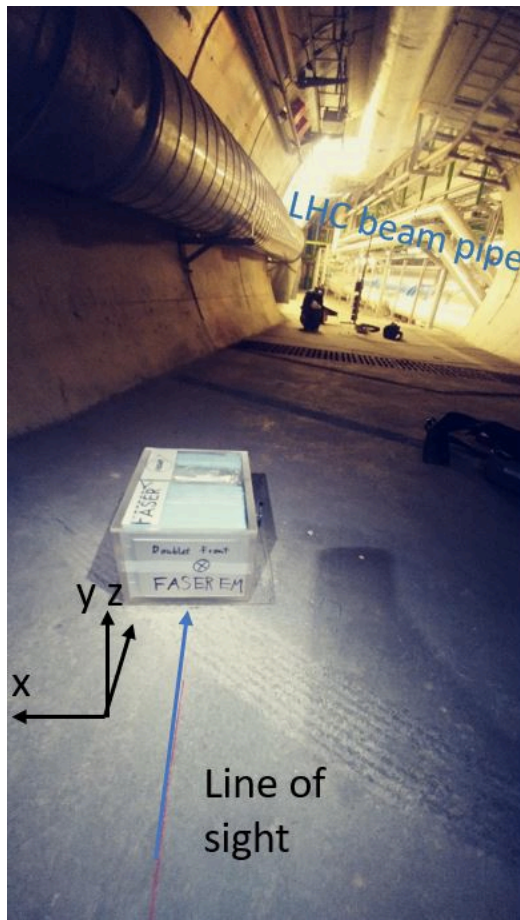

particles from IP1

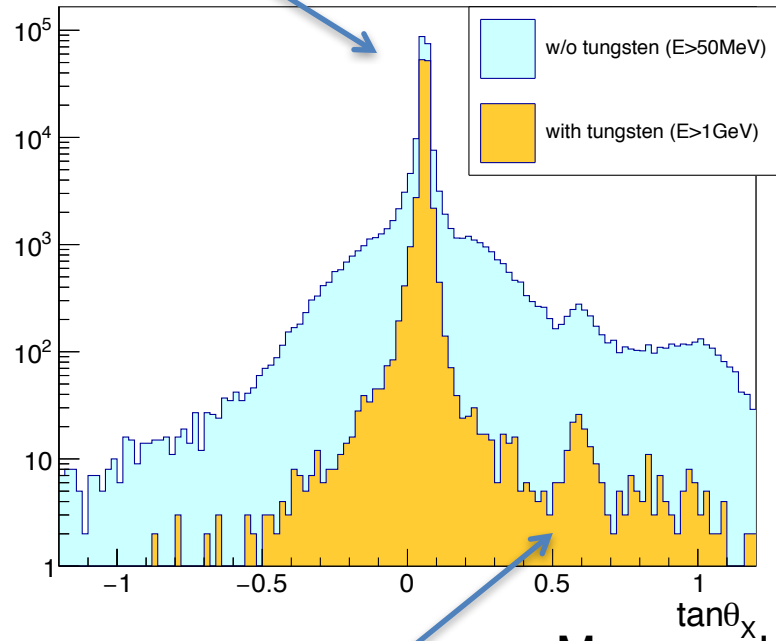

particles from LHC beam line

Measured angle in emulsion detector

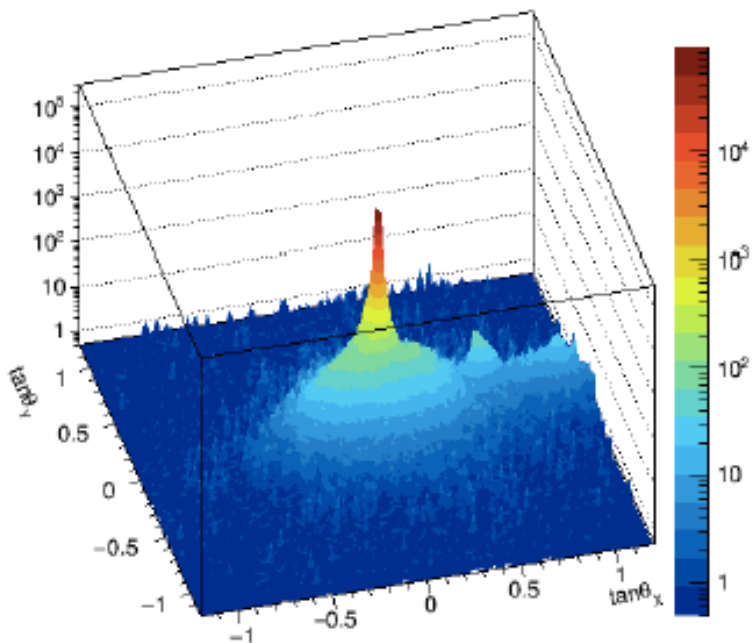
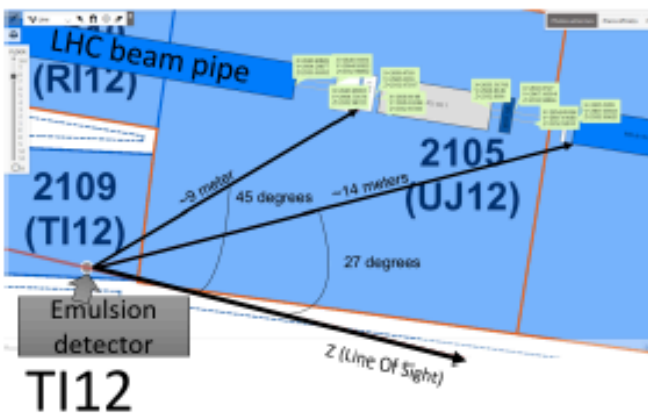
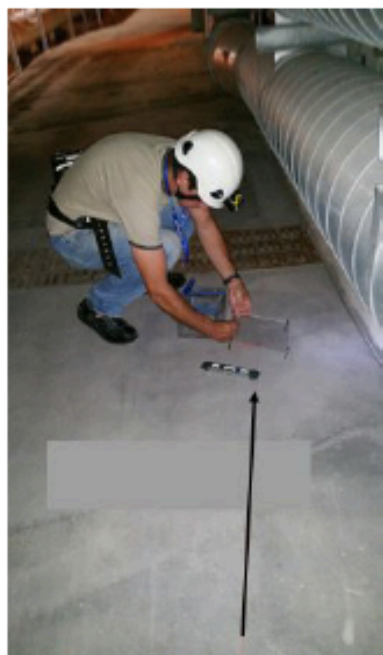
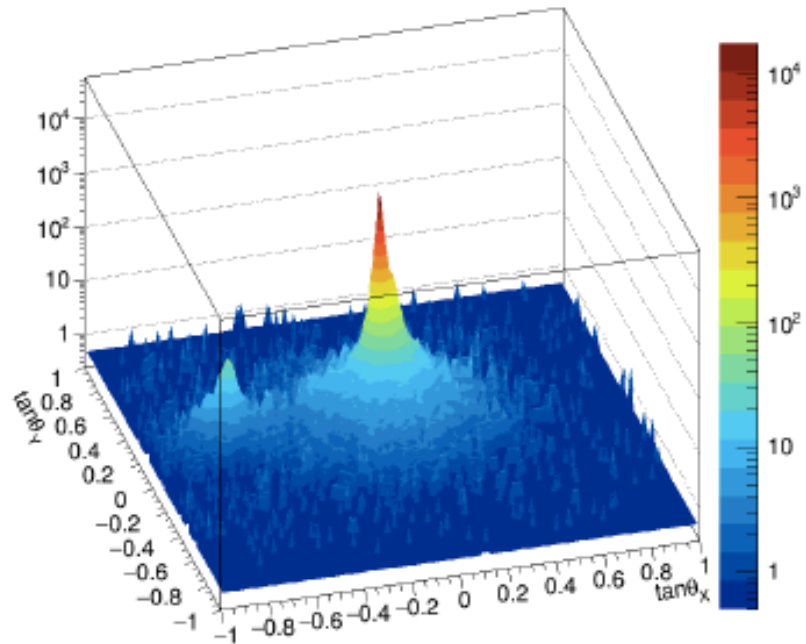
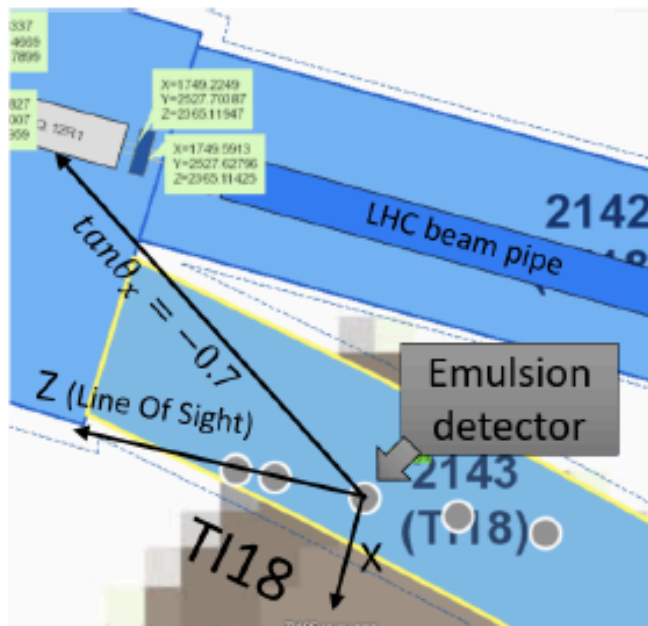
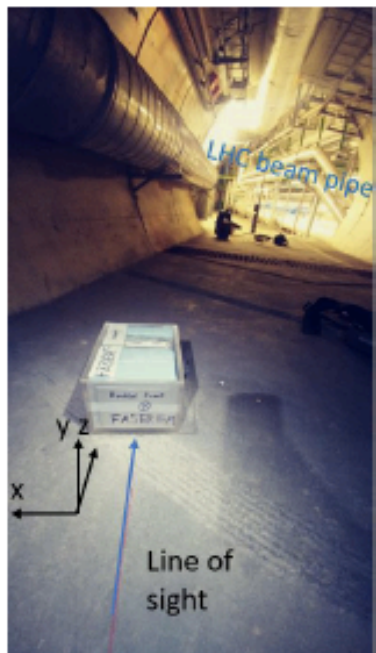

Linking FASER ν with FASER

- Possibility to connect FASER ν with rest of FASER for:
 - Charge identification
 - Improved energy resolution
 - Better background rejection
- Would require interface detector in front of FASER
 - Precision tracker to link FASER ν and FASER tracks
 - Most likely a fourth station of spare ATLAS SCT modules
- To not jeopardize FASER schedule, this would only be installed in 2021/22 YETS
 - Most data anyway expected after that

Simulation studies on-going to quantify possible gains

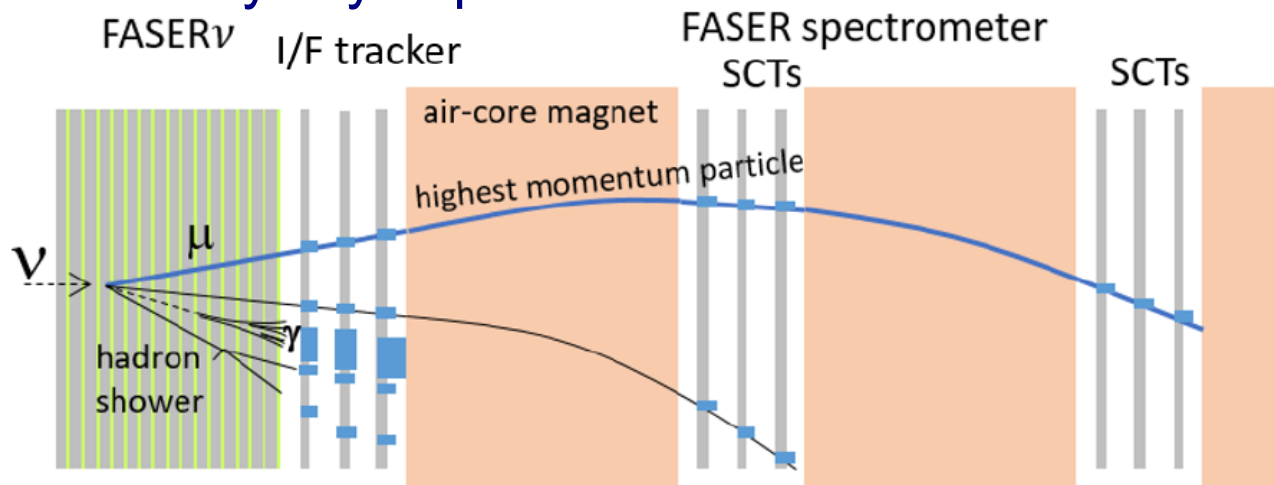

Track Momentum Reconstruction

- High granularity, high precision tracking allows momentum measurement using multiple coulomb scattering estimate
- Expect sub-micron alignment of layers thanks to large rate of high energy muons

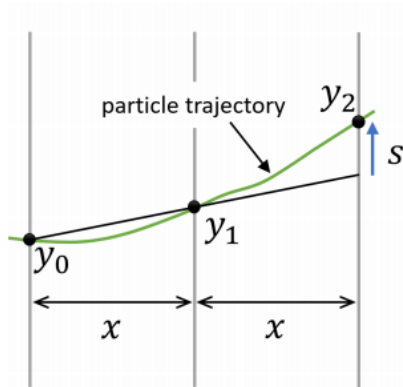

Reco momentum vs truth

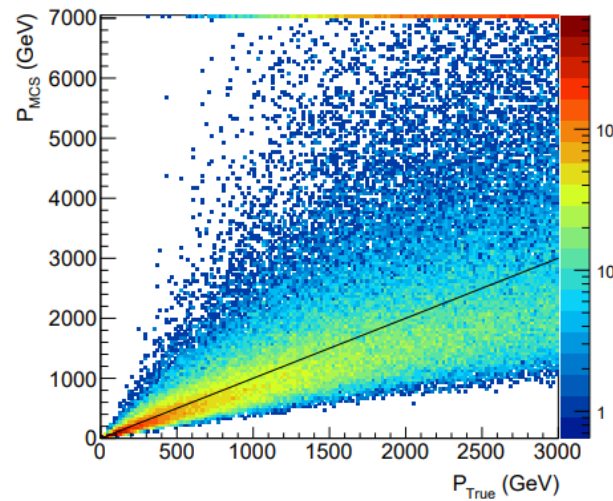

Max momentum vs position res.

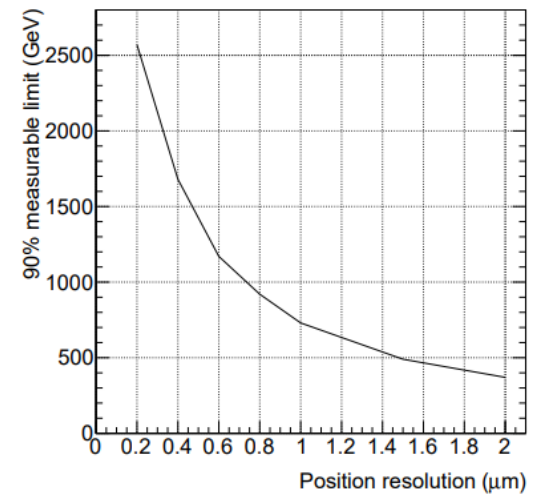

$$(\sigma_s^{\text{RMS}})^2 = \left(\sqrt{\frac{2}{3}} \frac{13.6(\text{MeV})}{\beta P} x \sqrt{\frac{x}{X_0}} \right)^2 + (\sqrt{6} \sigma_{\text{pos}})^2$$

Assumes $0.4\mu\text{m}$ resolution
and 100 traversed layers

Neutrino Energy Reconstruction

- Neutrino energy can be estimated from sum of visible energy
- Improved resolution under study using ANN to also combine with angular information

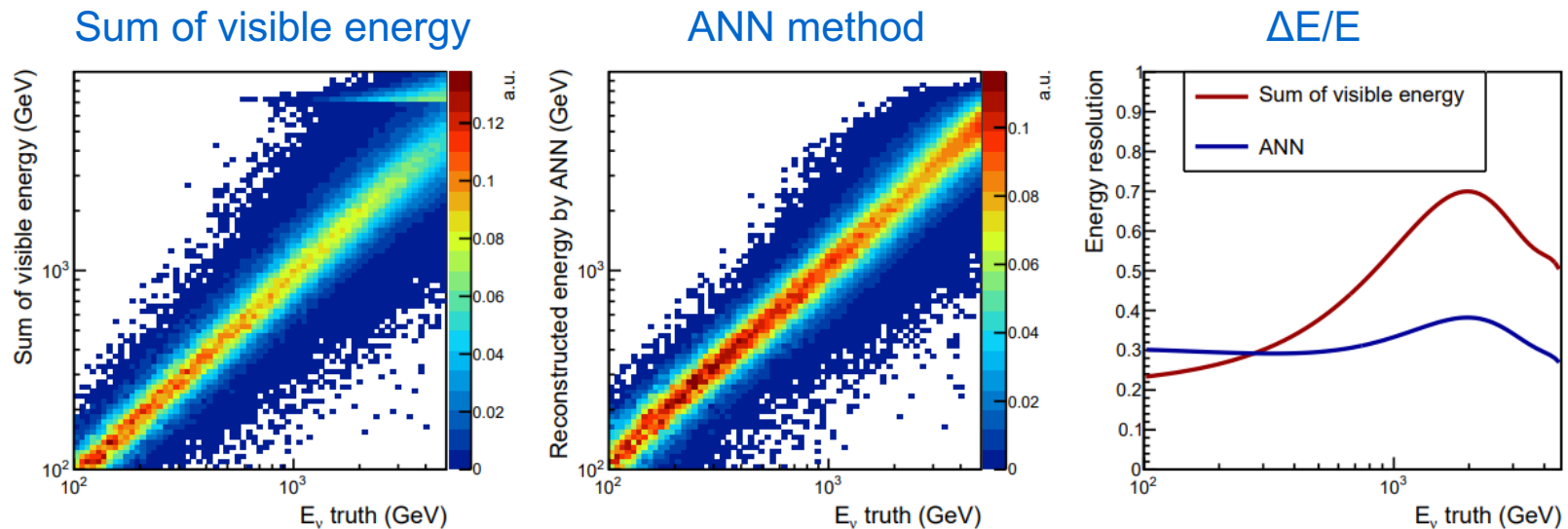

Emulsion Detector Structure

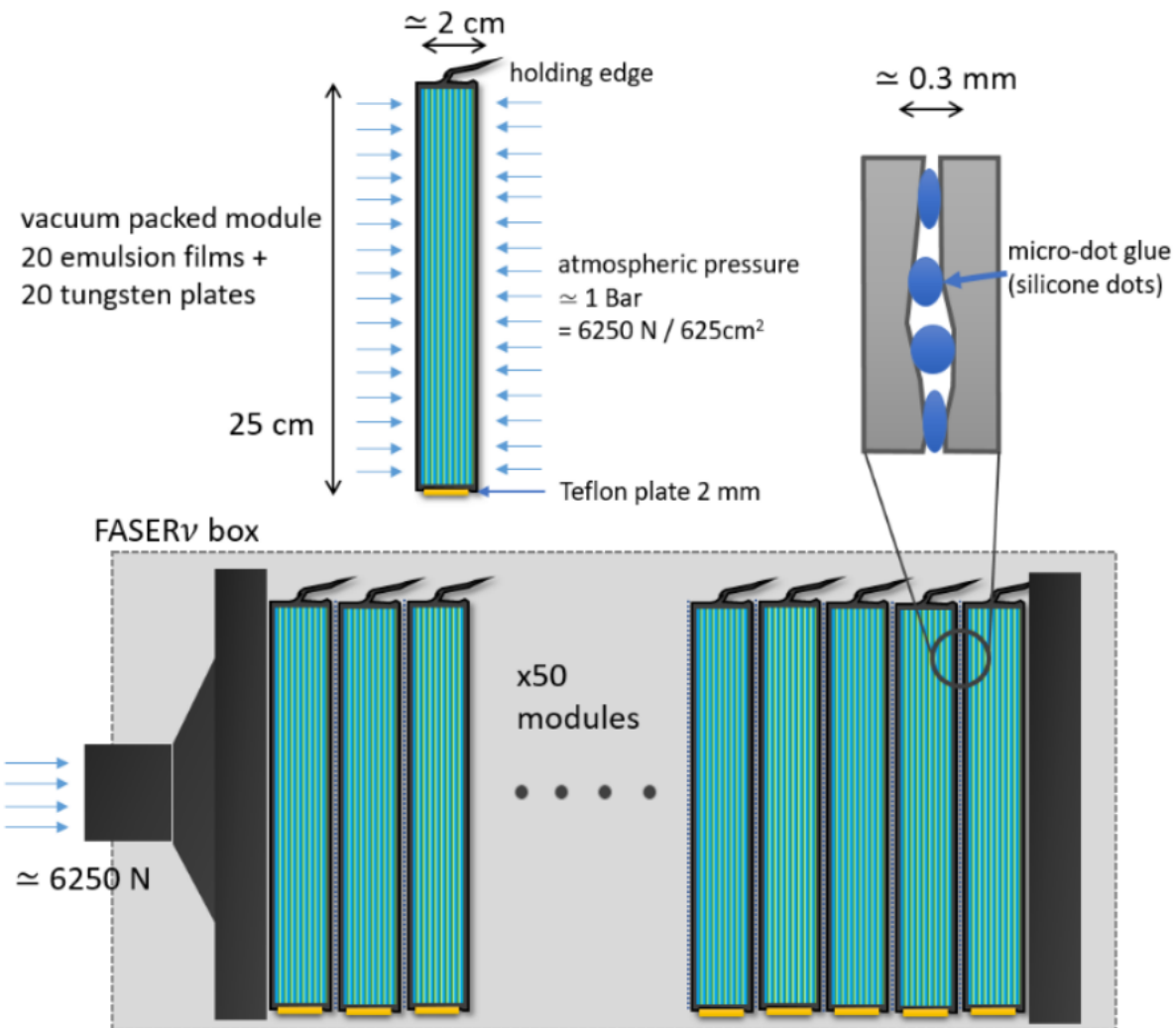

Vacuum-packed module



Mechanical support design

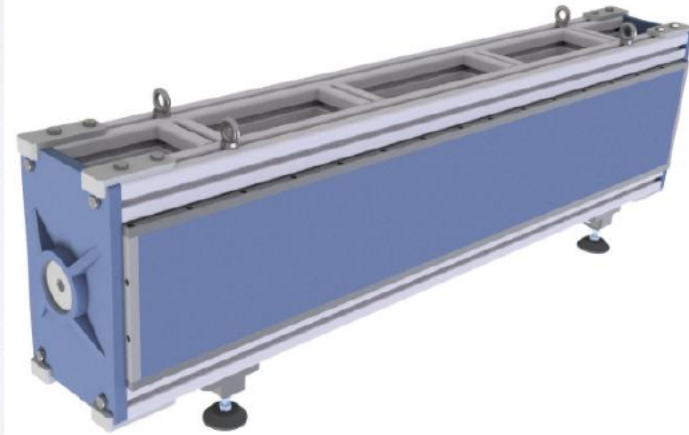

Emulsion Detector Sequence

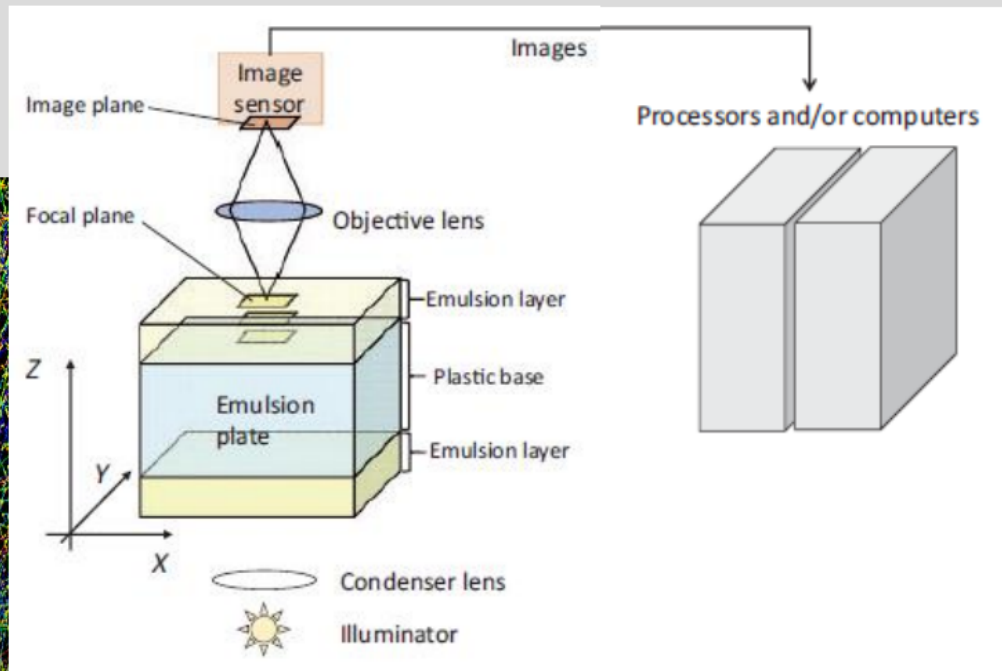
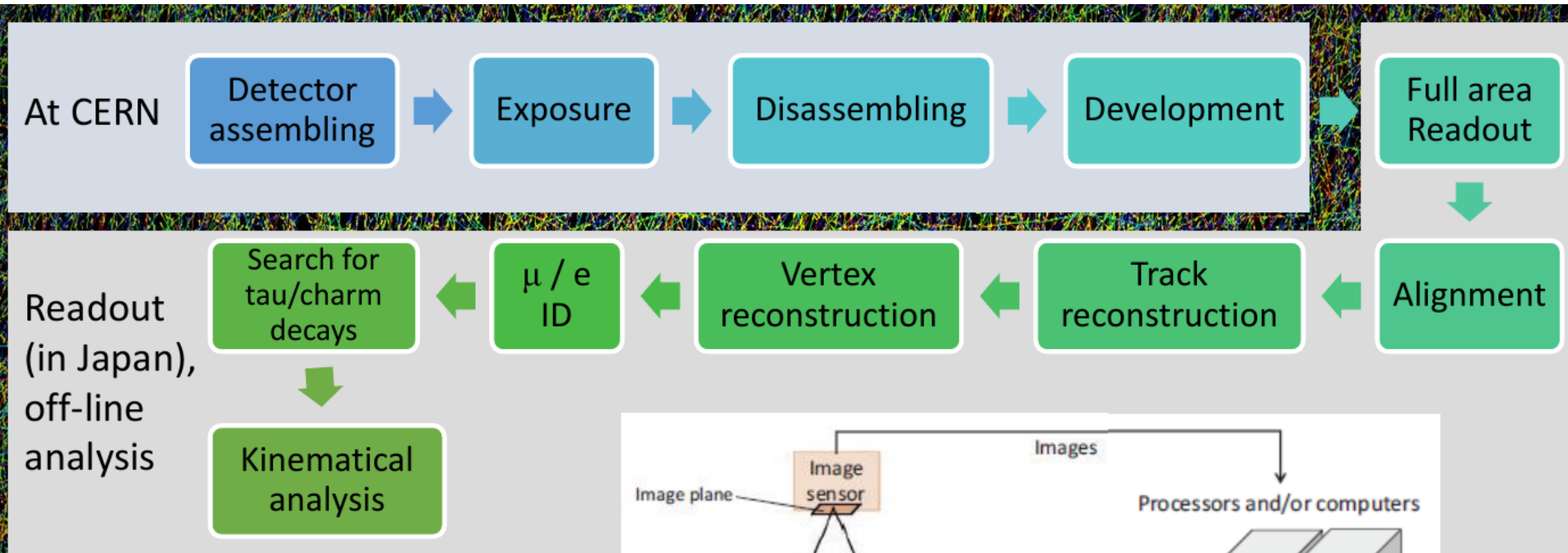

Emulsion Readout System

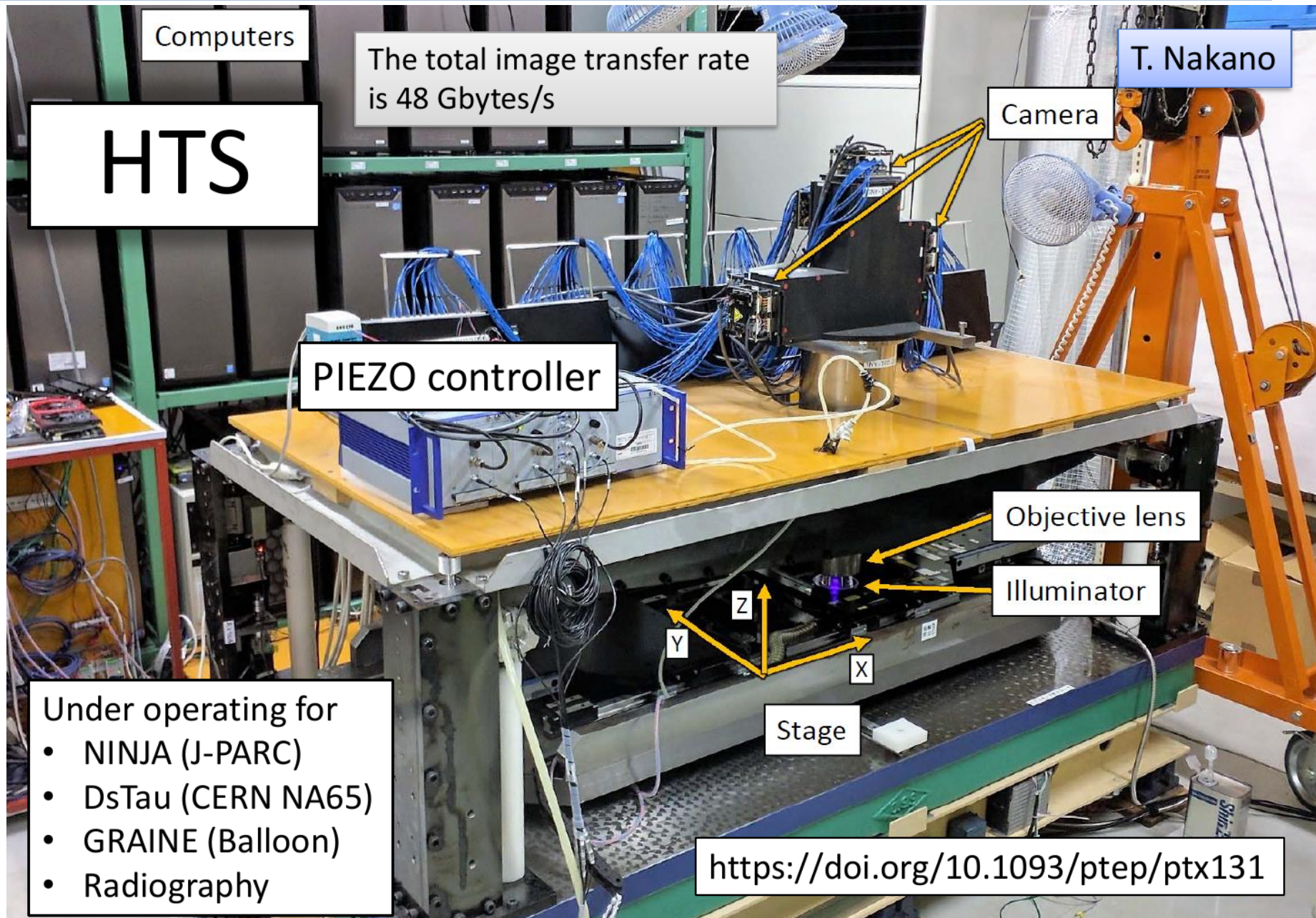

FASERnu Muon ID

Track length (cm)	Tungsten length (cm)	Plastic length (cm)	Prob. of pion flying through
130	97	33	0.00004
110	82	28	0.00018
90	67	23	0.00087
70	52	18	0.00417
50	37	13	0.01995
30	22	8	0.09549
10	7	3	0.45708

80% of detector volume allows $> 2 \lambda_{\text{int}}$ for muon ID.