

# Assembly and First Training of the Dipole Magnet FRESCA2

29/03/2017

E. Rochepault

On behalf of the FRESCA2 working groups:

**CERN-MDT:** A. Benfkih, N. Bourcey, A. Carlon Zurita, D. Cote, J. Ferradas Troitino, H. Dupont, N. Eyraud, P. Ferracin, B. Fornes, R. Gauthier, G. Maury, J. Muñoz Garcia, N. Peray, J.C. Perez, F.O. Pincot, G. de Rijk, S. Sequeira Tavares.

**CERN-TF:** V. Desbiolles, J. Feuvrier, G. Willering,

**CERN-MM:** L. Fiscarelli, C. Petrone, M. Probst

**SACM-LEAS:** R. Corriea-Machado, M. Durante, J.J. Goc, P. Leveque, P. Manil, J.F. Millot A. Przybylski, J. M. Rifflet, F. Rondeaux, S. Somson.

# Outline

1. The FRESCA2 project
2. Coil fabrication
3. Magnet assembly
4. Magnet test
5. Magnetic and Mechanical Analysis

# 1. The FRESCA2 project

# The FReSCa test facilities

1. **A new facility** to test superconducting cables in a high field environment  
FReSCa = Facility for the REception of Superconducting CABLEs

	Fresca1 [1-2]	Fresca2
Nominal bore field [T]	9.5	13
Short sample bore field at 1.9K [T]	10.0	17.5
Bore aperture [mm]	88	100
Short sample current at 1.9K [kA]	13.6	15.2
Stored energy at short sample [MJ/m]	0.7	5.5
E. M. Force Fx/quadrant [MN/m]	3.7	7.7
Field length [mm]	600	540
Total length [mm]	1700	2200
Outer diameter [mm]	740	1030
Mass [t]	7.8	8.8

[1] Verweij et al., "1.9 K Test Facility for the Reception of the Superconducting Cables for the LHC", IEEE 1999

[2] Leroy et al., "Design and Manufacture of a Large-Bore 10 T Superconducting Dipole for the CERN Cable Test Facility", IEEE 2000

# The Fresca test facilities

Fresca1

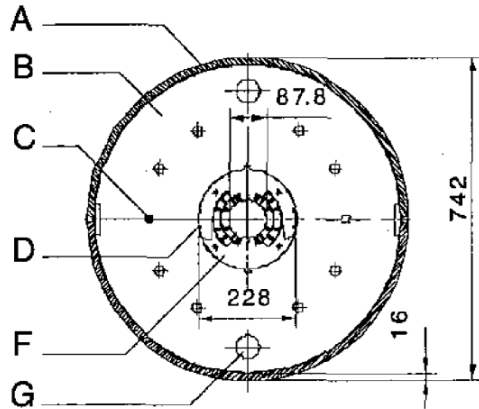

- A) Shrinking Cylinder
- B) Yoke
- C) Alignment Key
- D) Collar Key
- F) Collars
- G) Heat Exchanger Hole

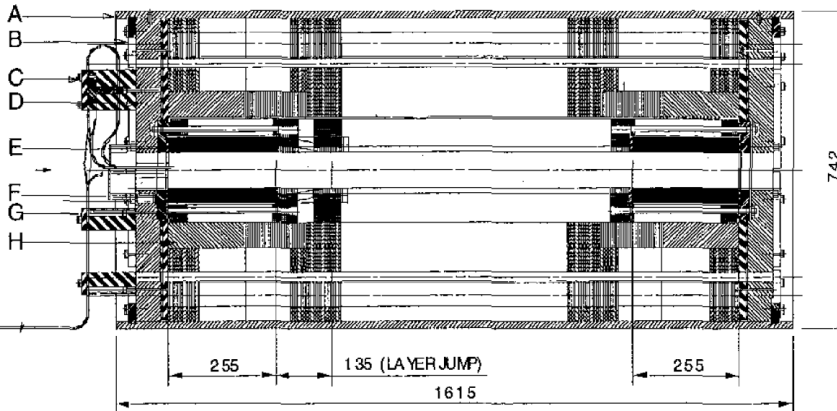

Fresca2

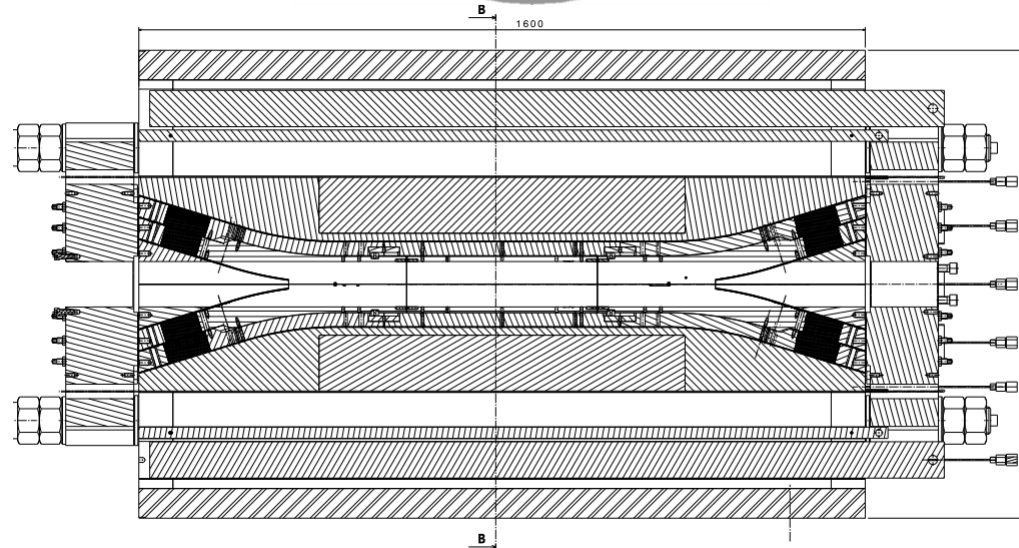
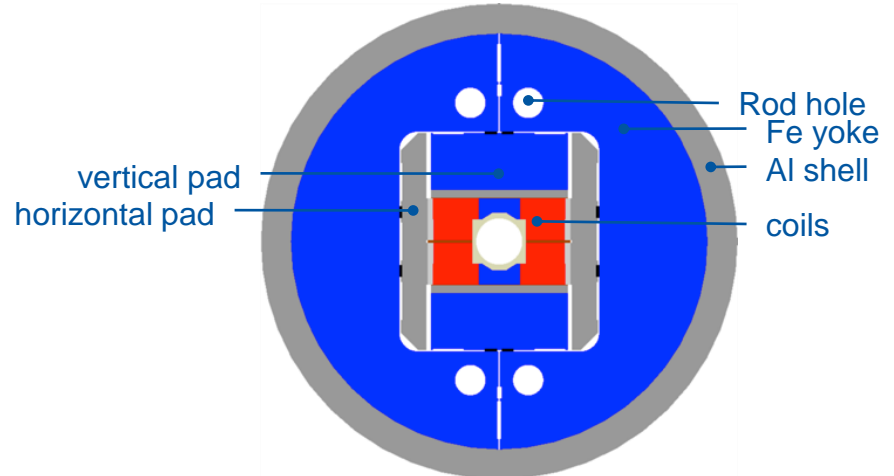

# The design

- Block coils with flared ends [3-4]
  - 2 Inner coil (Layers 1+2, coil ID 12##)
  - + 2 Outer coils (Layers 3+4, coil ID 34##)
  - **= 4 coils for 1 magnet**
- Inner support:
  - Inner coil: Titanium pole for mechanical strength
  - Outer coil: Iron pole for higher magnetic field
- Pre-load:
  - Bladders & keys
  - Shrinking aluminum shell
  - Tie rods + end-plate

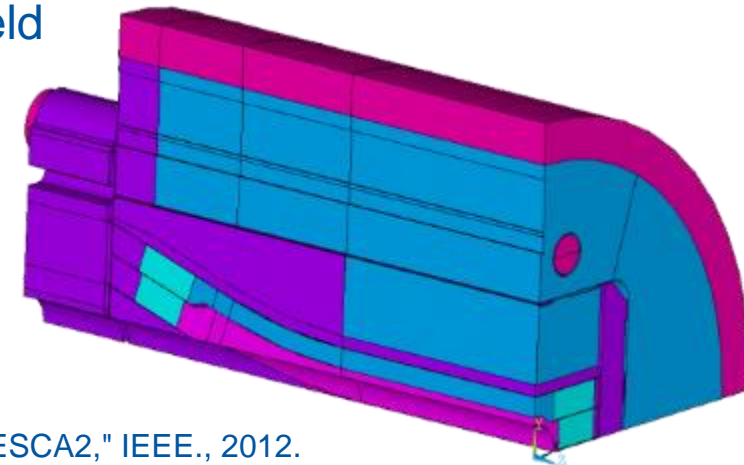
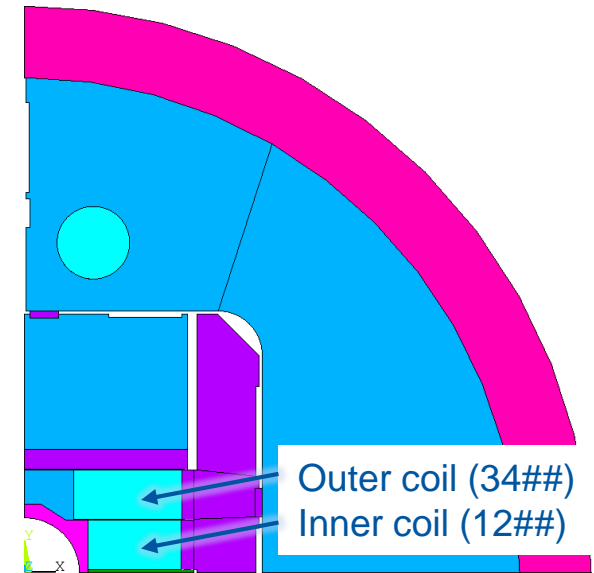

[3] Milanese et al., "Design of the EuCARD High Field Model Dipole Magnet FRESCA2," IEEE., 2012.

[4] Ferracin et al., "Development of the EuCARD Nb3Sn Dipole Magnet FRESCA2," IEEE, 2013.

# Towards (very) high fields

## 2. Provide feedback and develop the technology

for future FCC dipoles: 16 T, 50 mm bore

- ERMC/RMM [5]
- Block coil demonstrator? [6]

## 3. Provide background field for HTS inserts to explore the 15-20 T range

- Eucard 5.4 T REBCO tape [7]
- Eucard2 5 T Roebel or Rutherford cable [8]
- Feather-M2 Roebel cable [9]

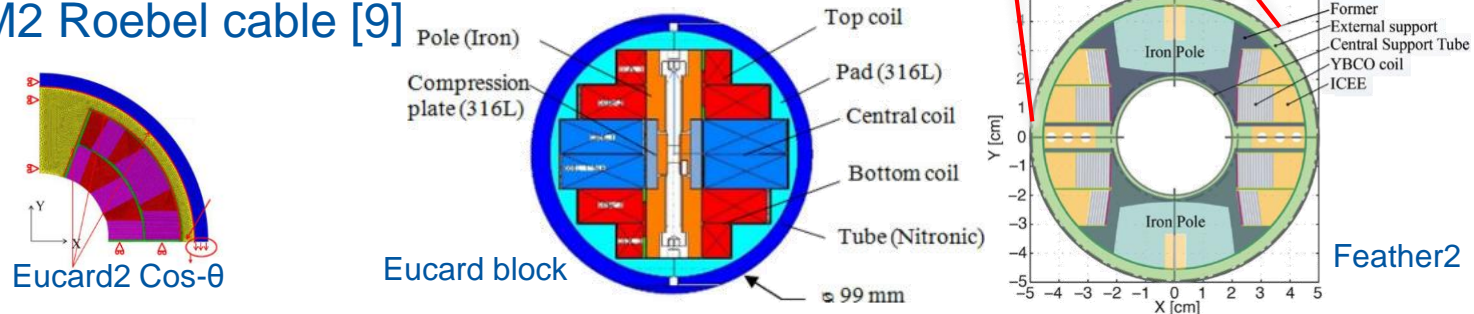
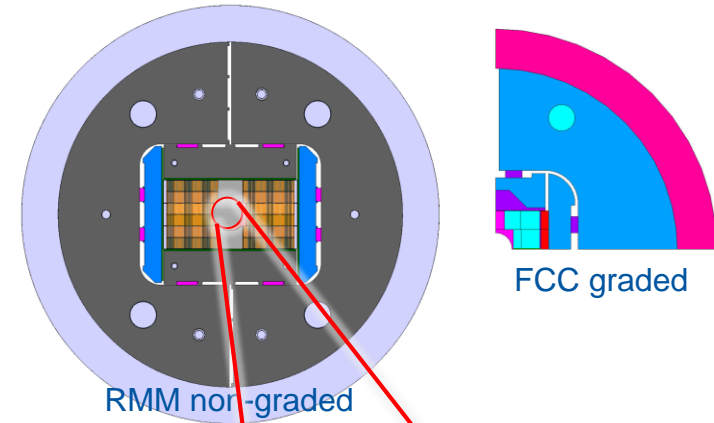

[5] Izquierdo et al., "Design of ERMC and RMM, the Base of the Nb<sub>3</sub>Sn 16 T Magnet Development at CERN", IEEE, 2017

[6] Lorin et al. "Block design EuroCirCol", Annual EuroCirCol WP5 meeting, 2016

[7] Borgnolutti et al., "Status of the EuCARD 5.4-T REBCO Dipole Magnet", IEEE 2016

[8] Lorin et al., "Cos- $\theta$  Design of Dipole Inserts Made of REBCO-Roebel or BSCCO-Rutherford Cables", IEEE 2015

[9] Kirby et al., "Accelerator-Quality HTS Dipole Magnet Demonstrator Designs for the EuCARD-2 5-T 40-mm Clear Aperture Magnet"

# 2. Coil fabrication



# Fabrication steps

## 1. Winding (Saclay) [10]



## 2. Reaction (CERN)



## 4. Impregnation (CERN)



## 3. Instrumentation/Insulation (CERN)

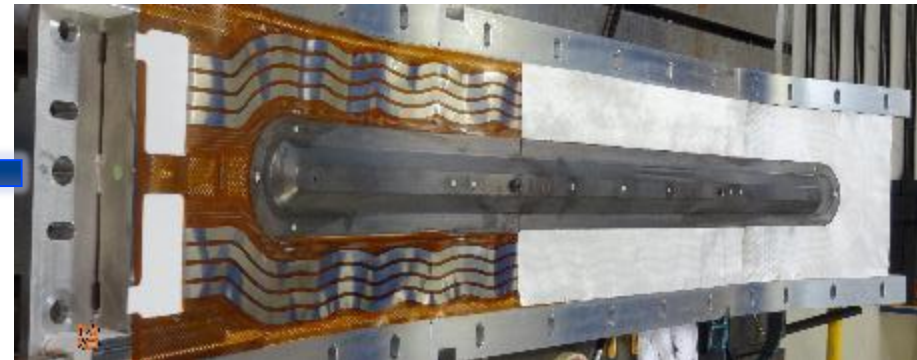

Validation tests

Coil pack assembly [11]

[10] Rondeaux et al., "Block type coils fabrication procedure for the Nb<sub>3</sub>Sn dipole magnet FRESCA2", IEEE 2016

[11] Rochepault et al., "Fabrication and Assembly of the Nb<sub>3</sub>Sn Dipole Magnet FRESCA2", IEEE 2017

# List of coils

Coil	Conductor	Type	Status	To be used
CR1201	RRP	Inner	Accepted	For 1st magnet assembly
CR3401	RRP	Outer	Accepted	For 1st magnet assembly
CR3402	RRP	Outer	Accepted	For 1st magnet assembly
CR1202	RRP	Inner	Accepted	For 1st magnet assembly
CR3403	RRP	Outer	Waiting for final acceptance test	For 2nd magnet assembly
CP1203	PIT	Inner	Waiting for impregnation	As a spare coil
CP3404	PIT	Outer	Procurement of components	As a spare coil

# CR3401, a series of bad luck...

- **Strands damaged** during the splicing operation
- **Additional Cu stabilizer soldered on the damaged area**
  
- Superficial bubbles due to some air trapped in the pole cavity
- **Local injections of resin**
- **Electrical tests passed**

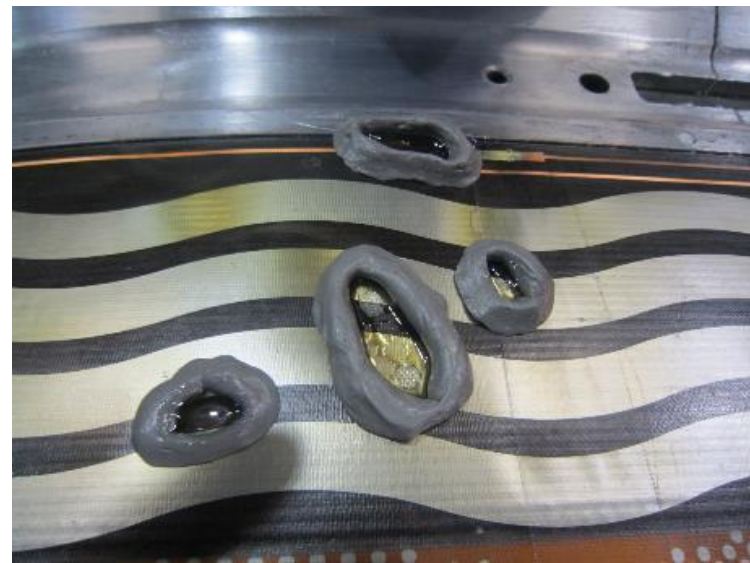

# 3. Magnet assembly

# Assembly steps

1. Tailored shim assembly x2



2. Positioning of mid-shims and wedges, x2



3. Assembly of 2 double-coils



6. Interconnections

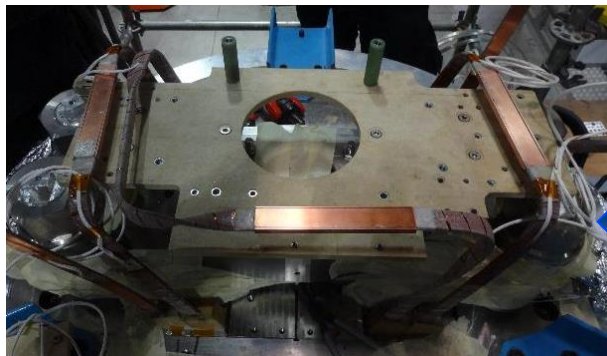

5. Coil-pack insertion and pre-load in the structure

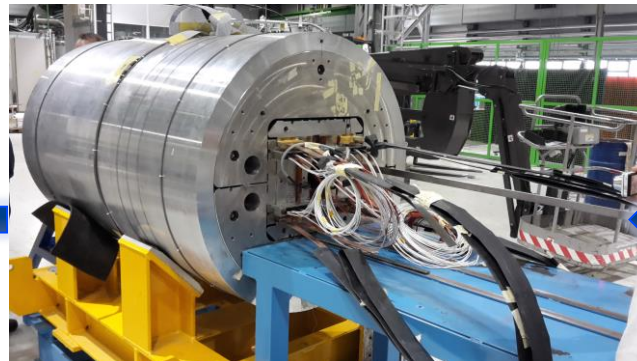

4. Coil-pack assembly



# Tailored shim assemblies

- 1 inner coil and 1 outer coil = half a dipole magnet
- Pole-to-pole contact:
  - Reference for assembly
  - Transmission of vertical pre-load
  - Electrical insulation → 125  $\mu\text{m}$  kapton foil
- Injection of charged resin MY750
- Goals of the tailored shim:
  - Fill the gap between 2 coils
  - Adapt to the gap variations
  - Provide a soft mechanical support
  - Provide an electrical insulation
- After dimensional control analysis, geometry more favourable with:
  - CR1201+CR3402
  - CR1202+CR3401

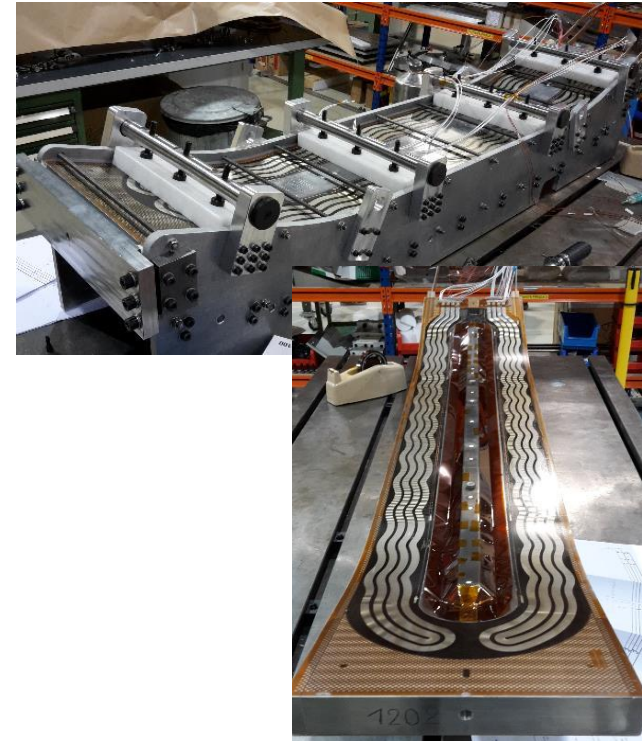
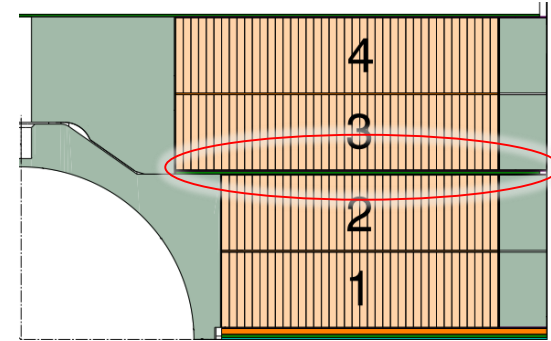

# Coil pack assembly

## Critical steps:

- Positioning of wedges and shims
- Good contact in the mid-plane
- Good electrical insulation

Shorts coil-post  $\rightarrow$  posts need to be insulated



# Pre-load #1

- Target for 13T.
- 3 intermediate steps (1 step = transverse loading + longitudinal loading).



Transverse loading  
bladders & keys



Longitudinal loading  
piston & rods



# Pre-load for 13 T

Target: 20 MPa average coil-pole contact

→ **Preloads: 0.5 mm horizontal + 1.5 mm axial**

✓ Marginal tension and gaps

✓ Peak stress < 150 MPa during operation

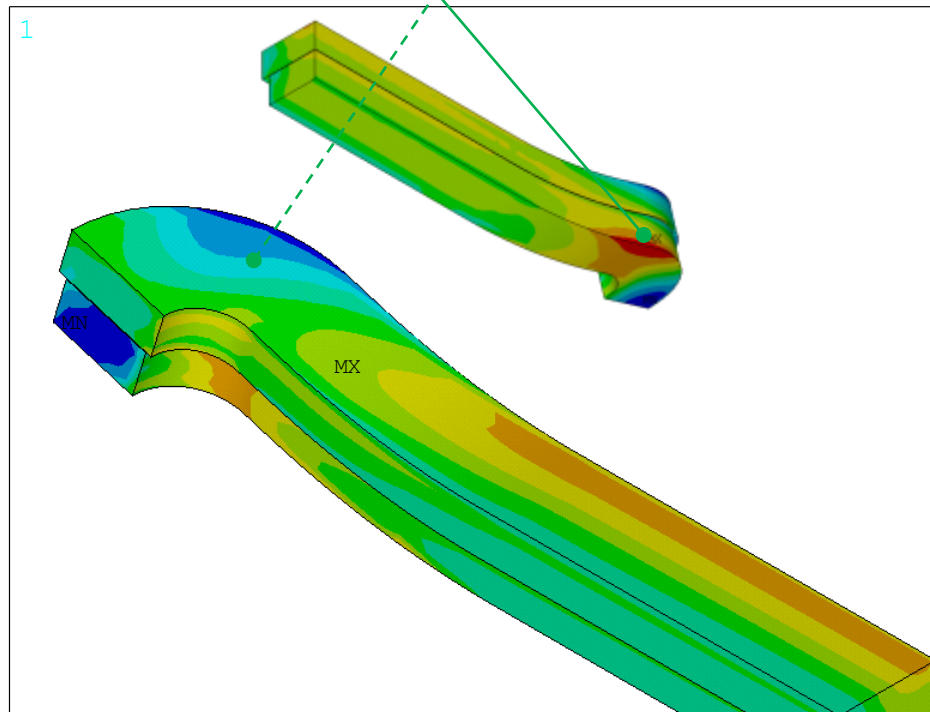
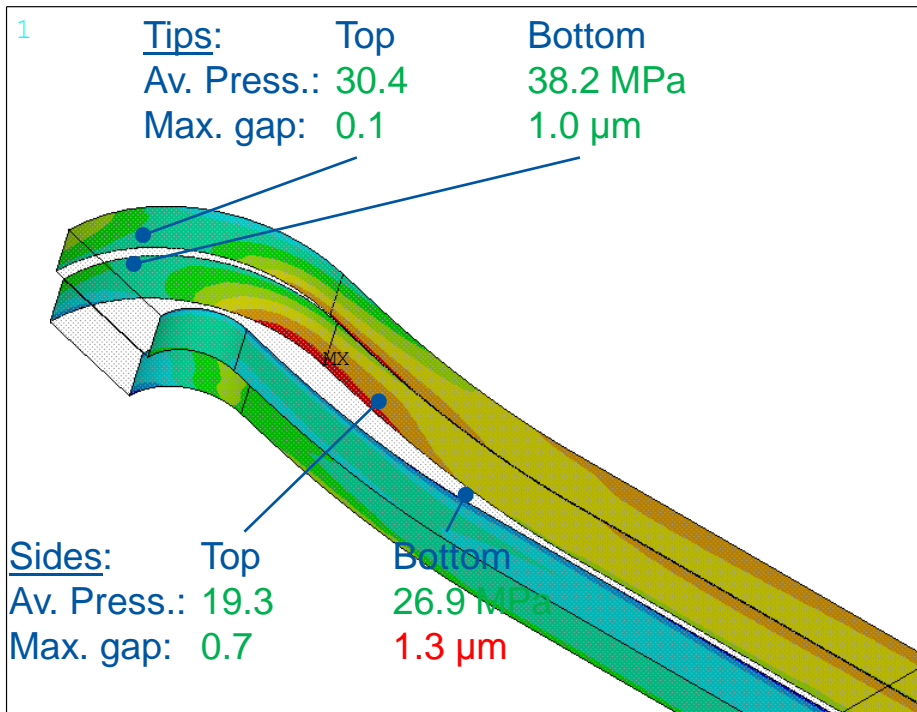

# Strain gauge locations

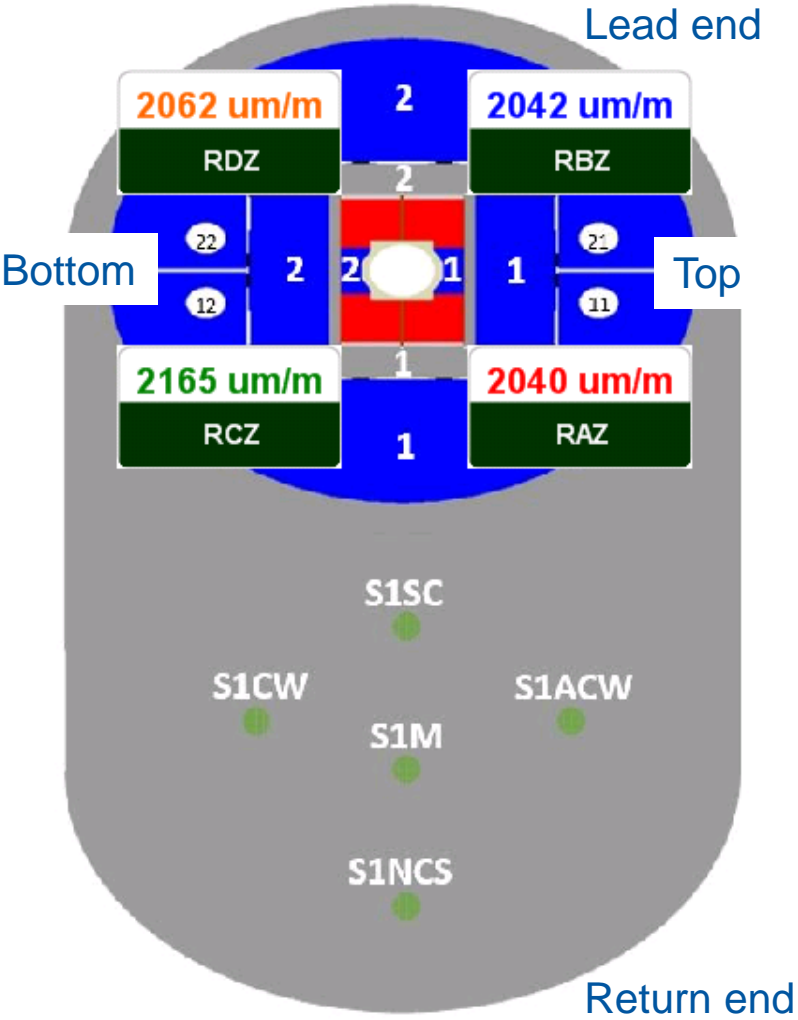

**Magnet conventions**  
View from return end  
(Configuration during loading)

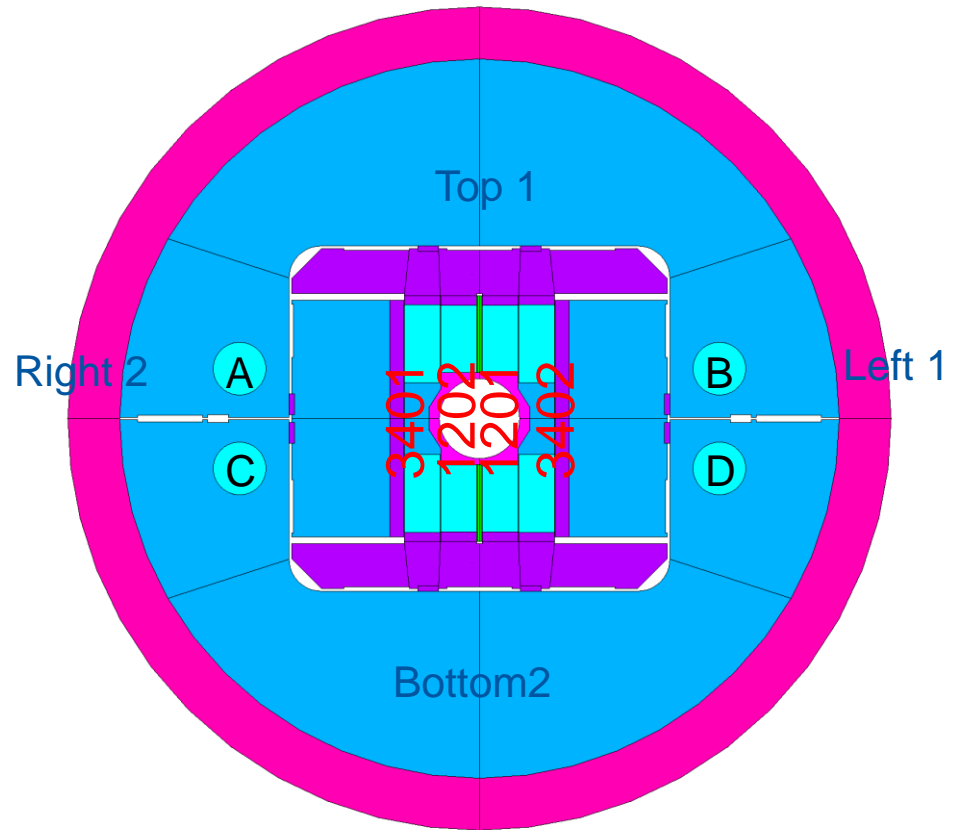

# Validation of the structure

- 3 Cool-Down cycles with aluminum dummy coils [12-13]

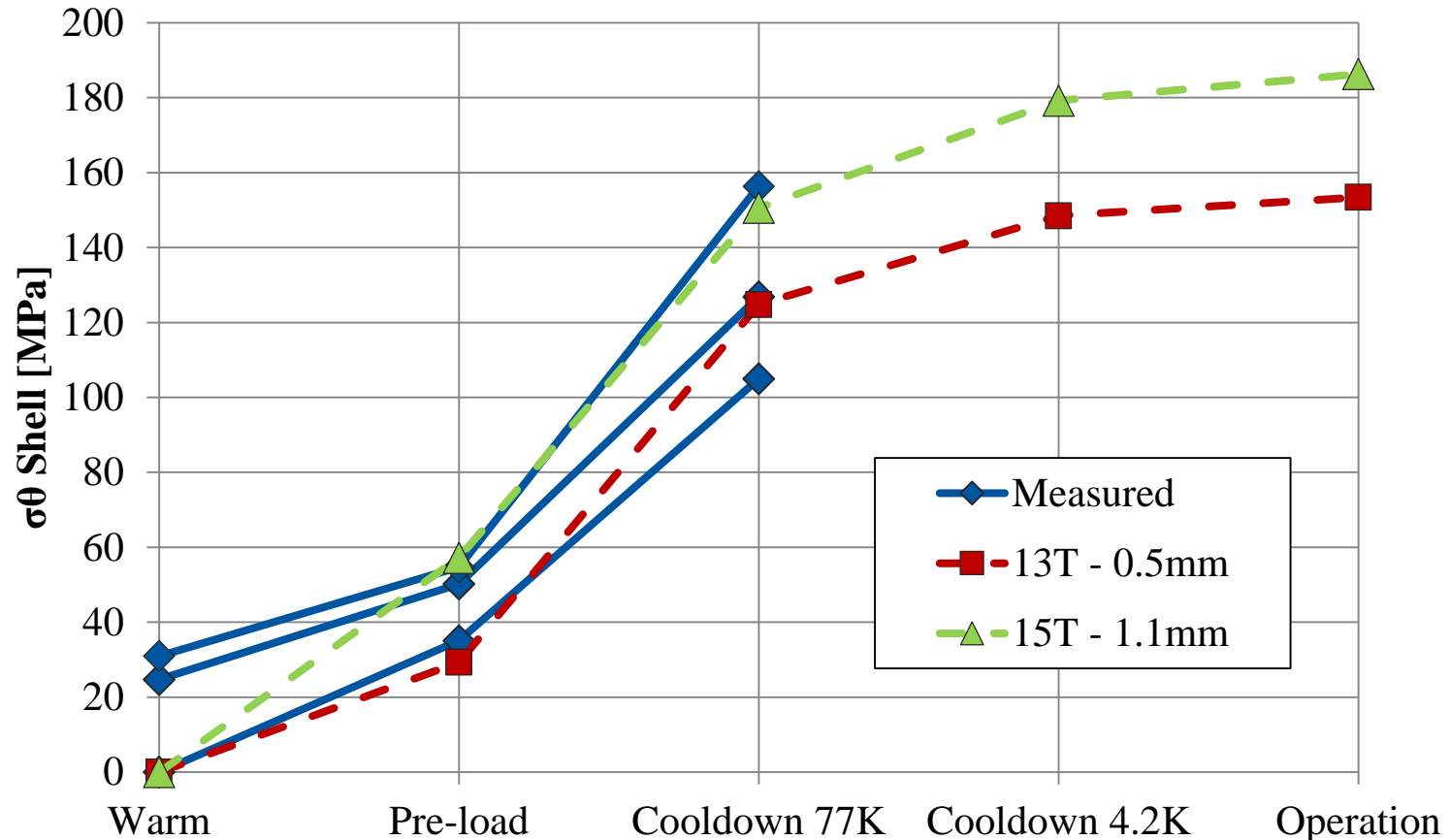

[12] Muñoz Garcia et al., "Assembly, Loading, and Cool-Down of the FRESKA2 support structure," IEEE 2014.

[13] Muñoz Garcia et al., "Mechanical Validation of the Support Structure of the Nb<sub>3</sub>Sn Magnet FRESKA2," IEEE 2015.

# Transverse loading

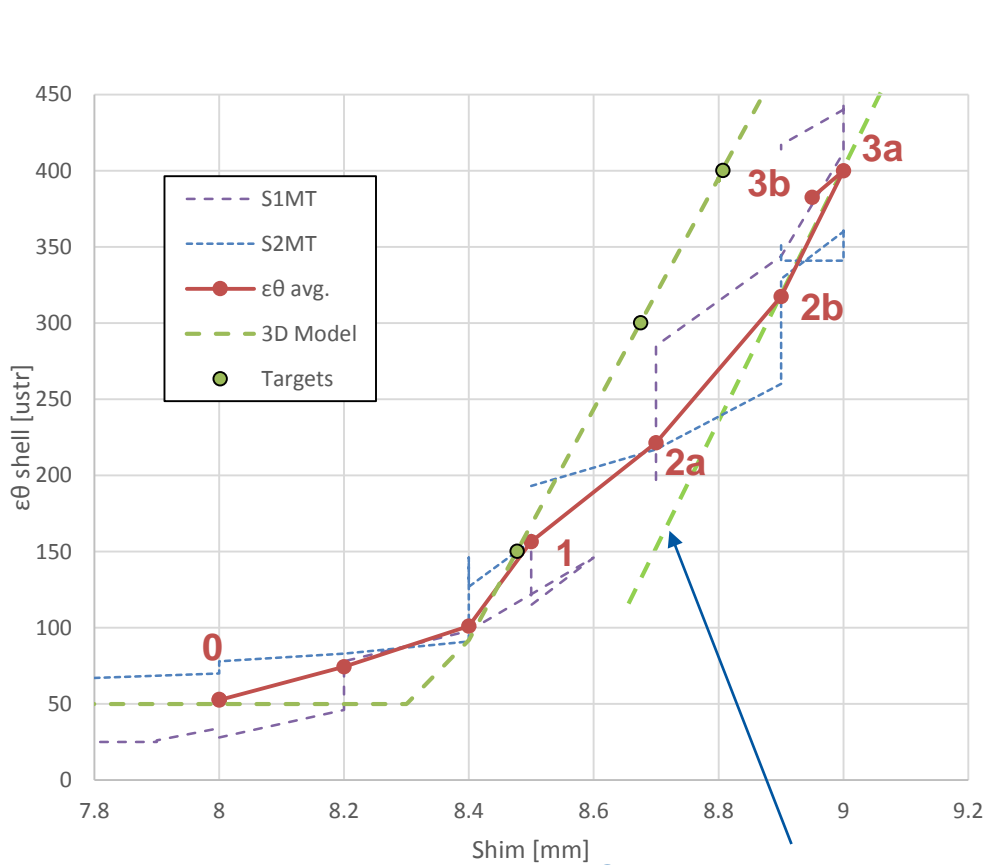

Slope ok, but +0.2 mm shift between 1 and 2b

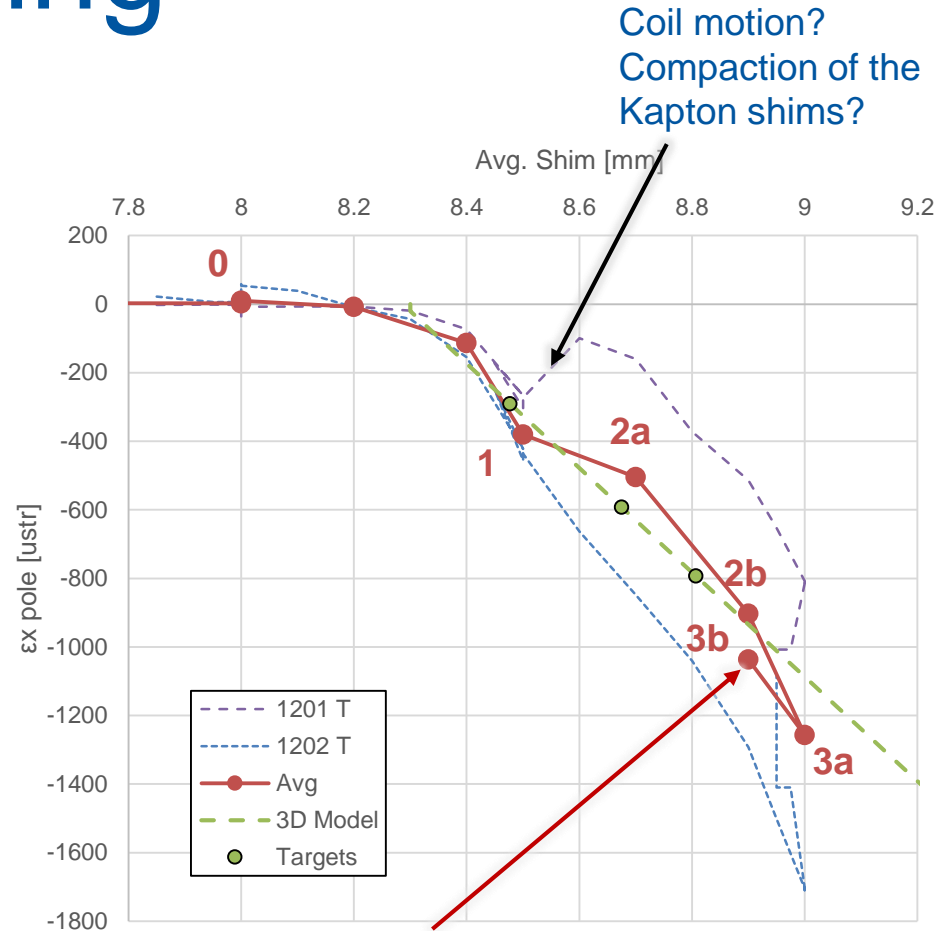

3b: asymmetric loading  
 9.0 mm on 1201  
 8.9 mm on 1202

# Transverse loading

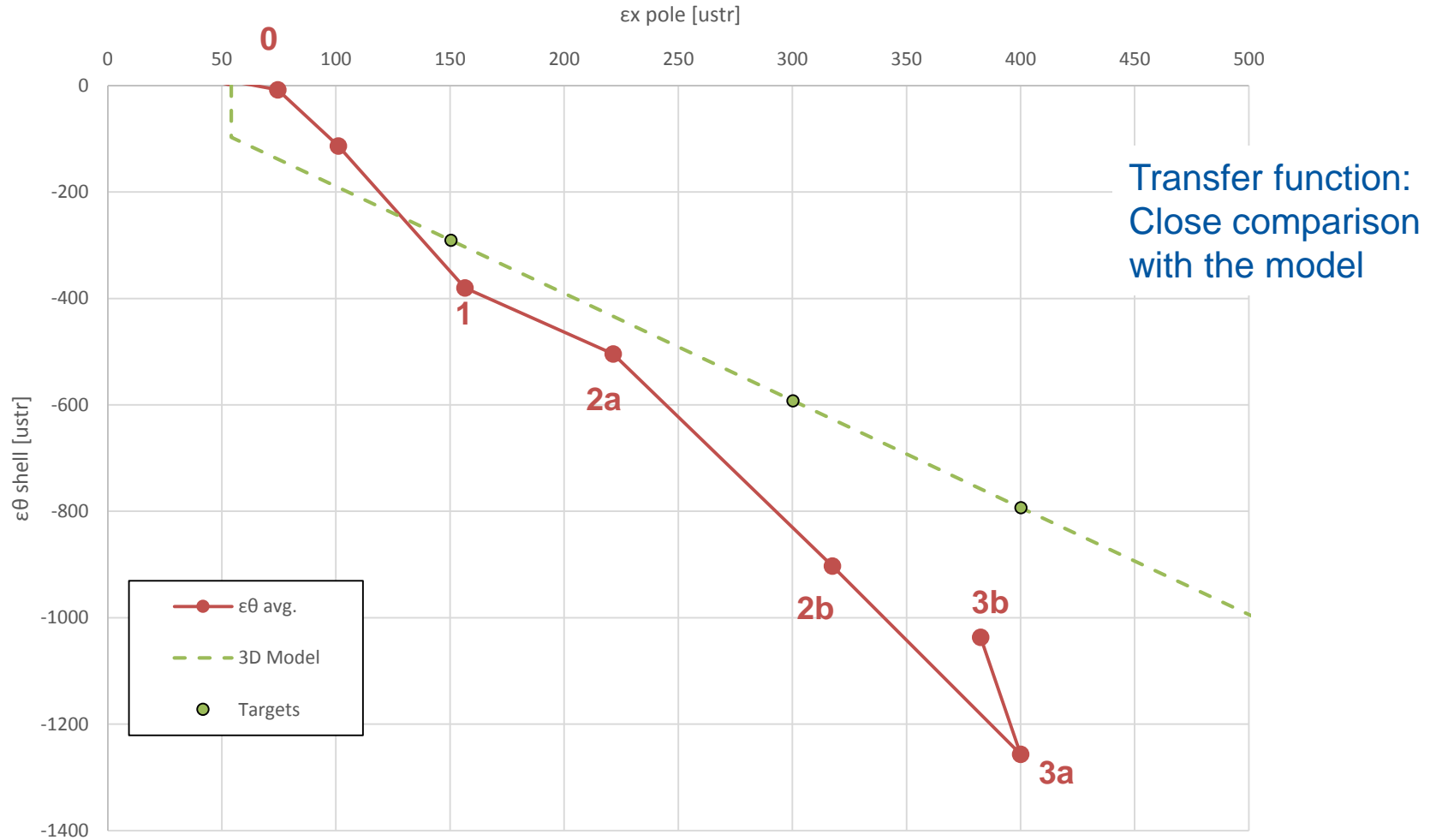

# Longitudinal loading

During Piston

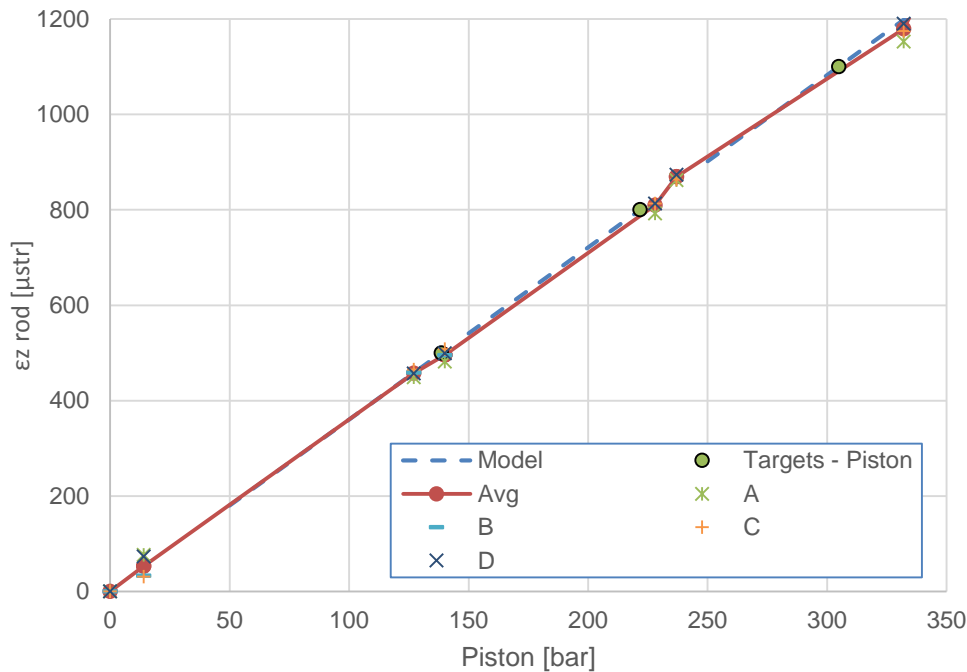

After bolting

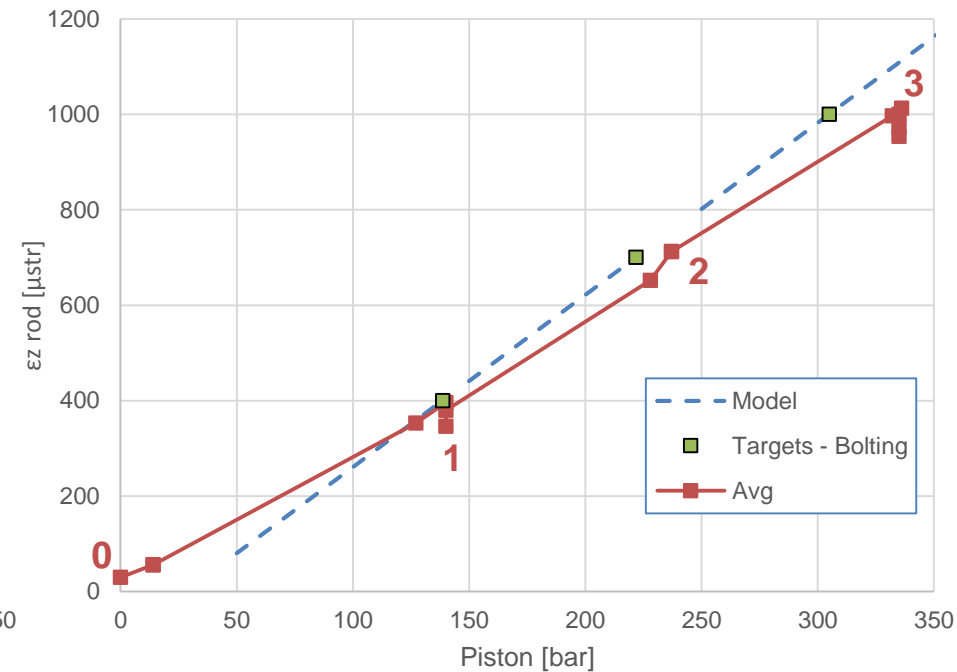

→ Very close comparison with the model

# Longitudinal loading

After bolting

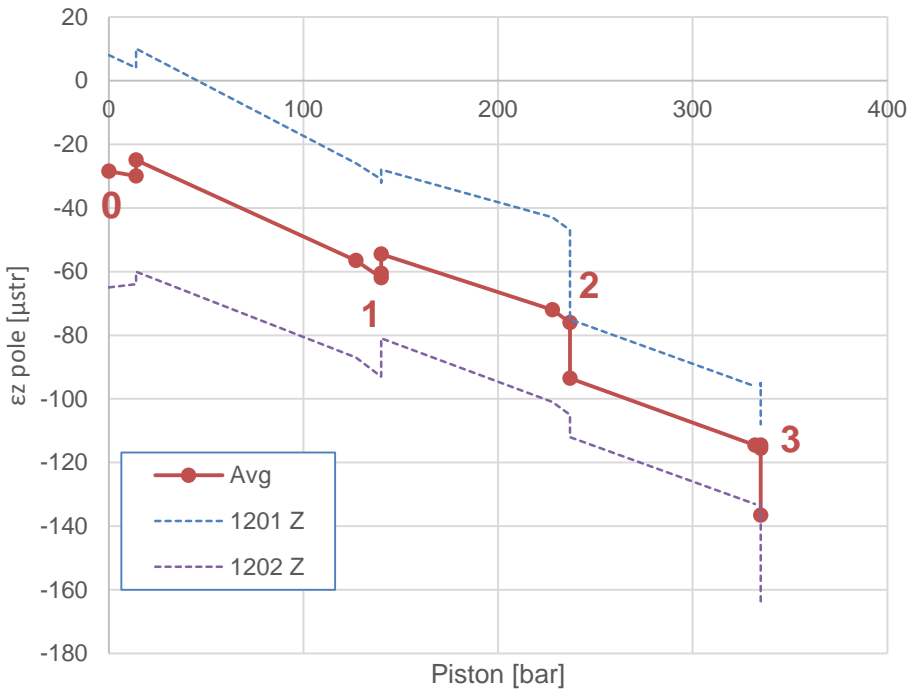

→ The coil is slightly pre-loaded longitudinally

After bolting

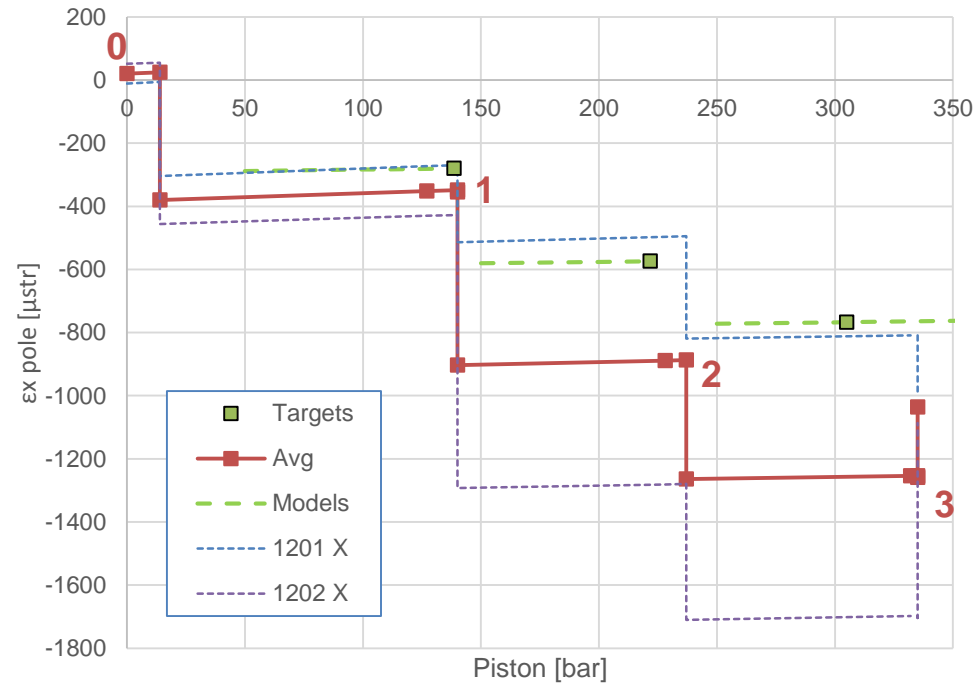

→ Small impact of longi. Pre-load on the transv. Pre-load (+10μstr)

# Interconnections/Instrumentation

- Splicing the leads
- Connection of instrumentation
- Final electrical acceptance tests of the magnet
  - High potential
  - Coil discharge
  - QH discharge

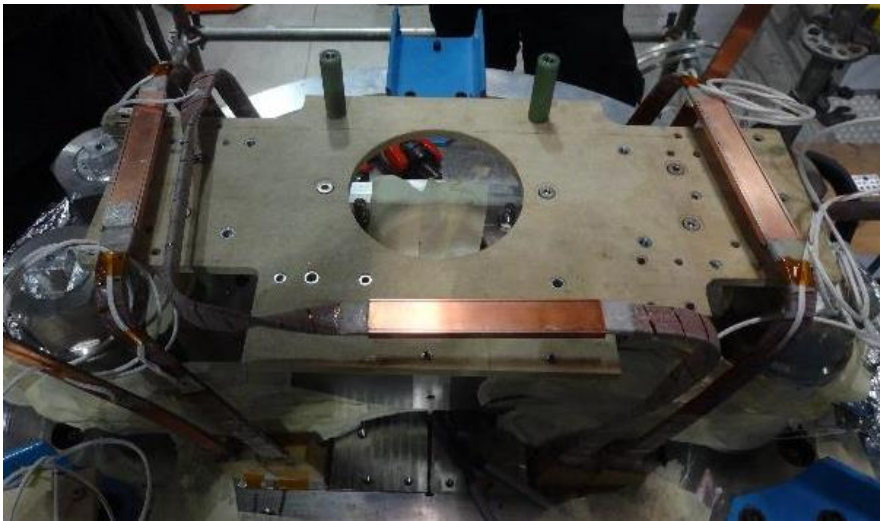
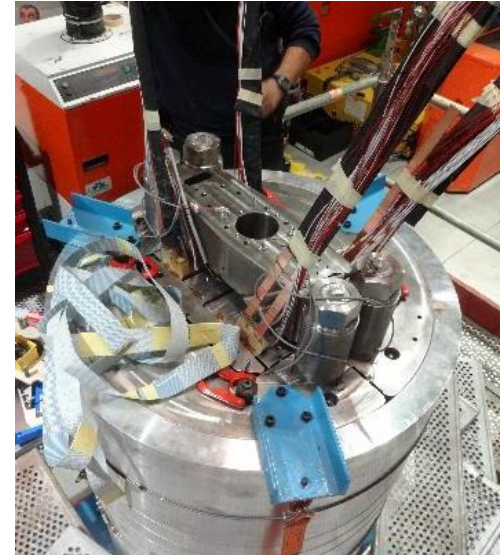



# 4. Magnet test

# Load lines and margins

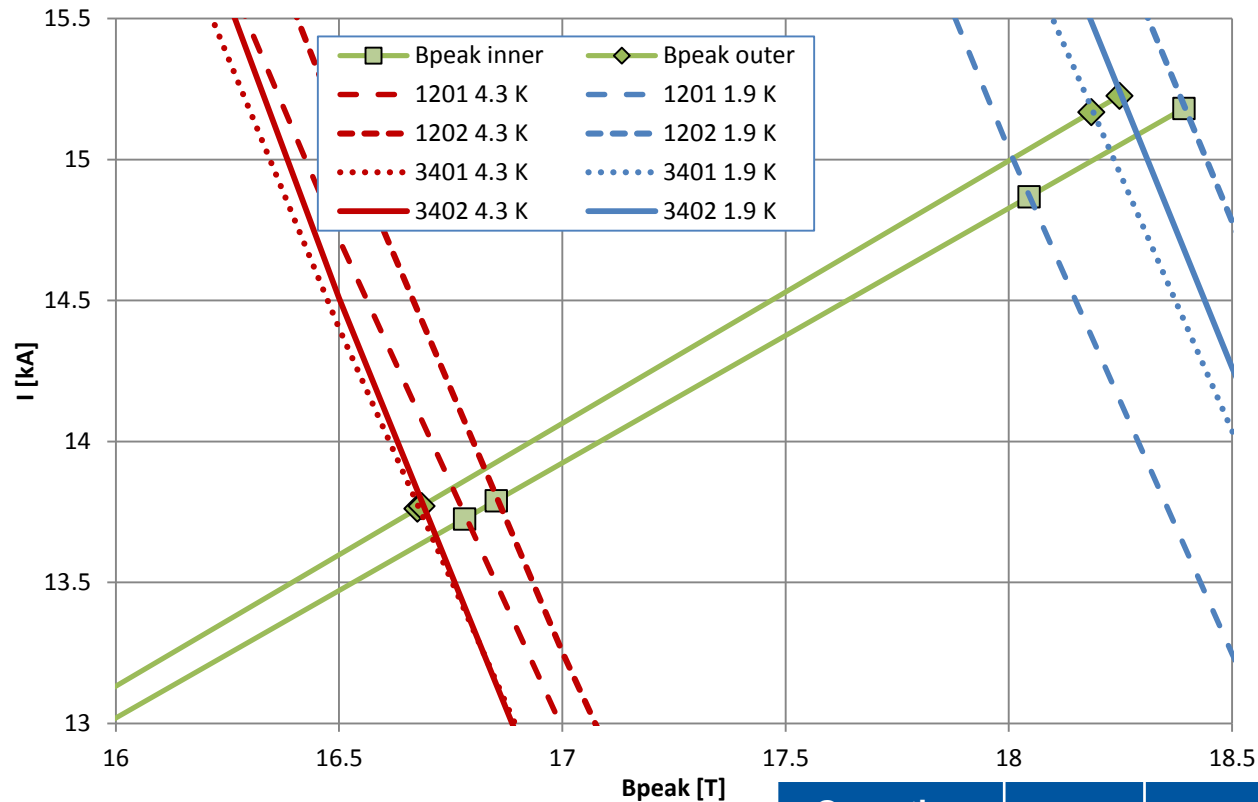

- Past experience with high field Nb3Sn magnets (HD, HQ, MQXF...): 10-15% degradation

Operating Point	I [kA]	B <sub>p</sub> [T]	Coil	Margins [%]	
				4.3 K	1.9 K
13 T	10.58	13.30	Inner	23	29
15 T	13.76	15.40	Inner	9	16
SS 4.3 K	13.73	16.78	1201	0	8
SS 1.9 K	14.87	18.05	1201	-	0

# Damaged splice



- Splice resistance  $\sim 1 \text{ n}\Omega$   
(other splices  $\sim 0.25 \text{ n}\Omega$ )
- Instabilities when holding current at 6 kA
  - Drift (decay)  $\rightarrow$  current redistribution?
  - Spikes  $\rightarrow$  flux jumps?

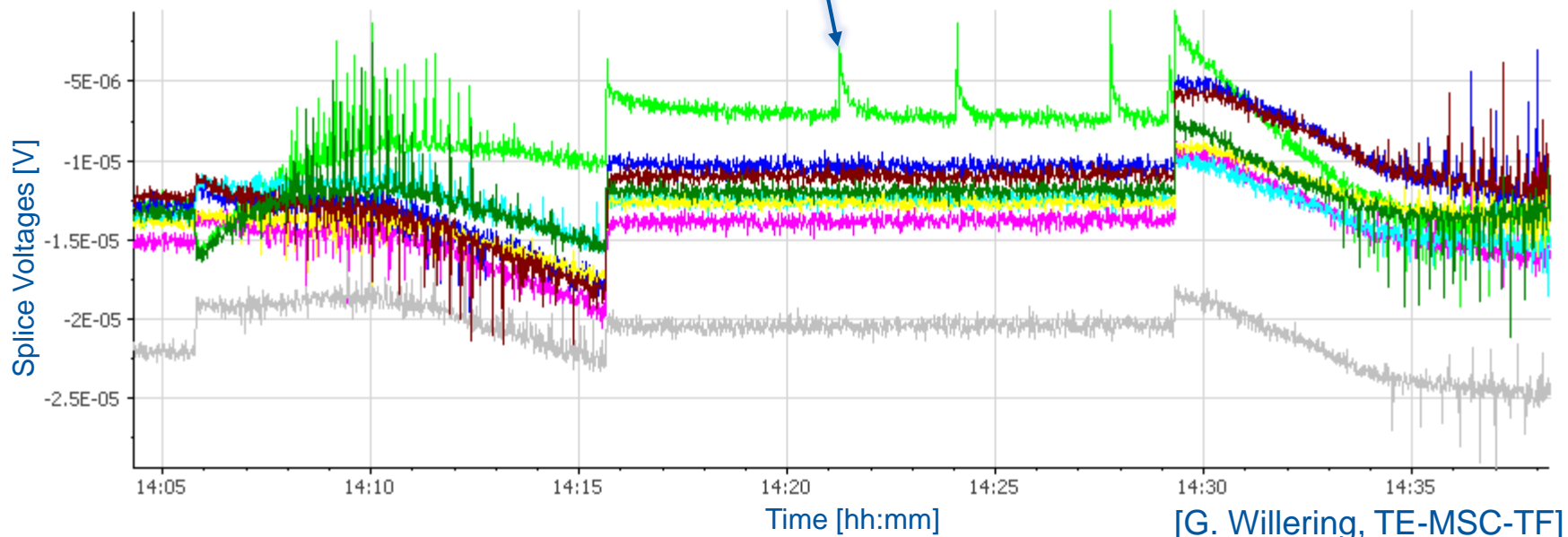

[G. Willering, TE-MS-C-TF]

# Training

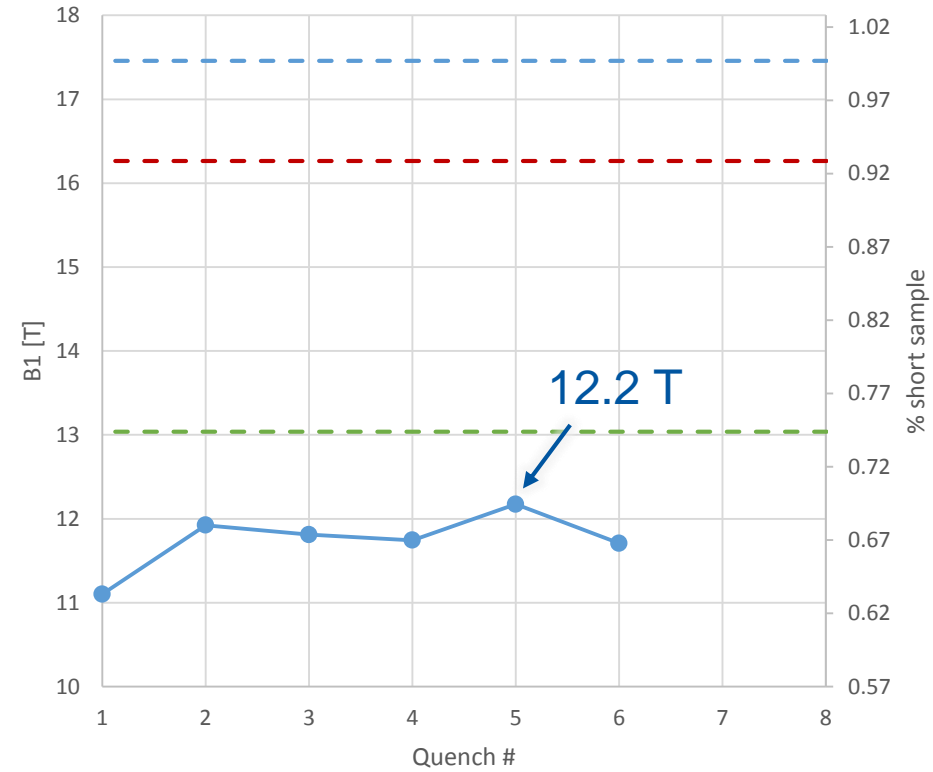
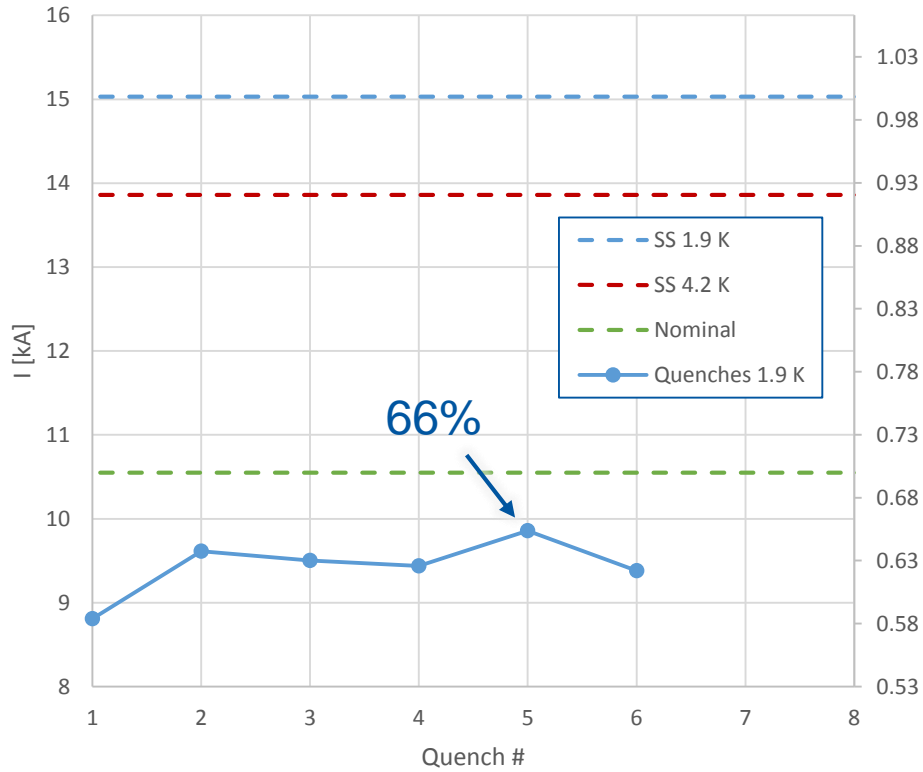

# Training location

## Quench 1:

8.8 kA

11.1 T bore field

CR1201, upper layer, around voltage tap

CR1201-U3, pole turn

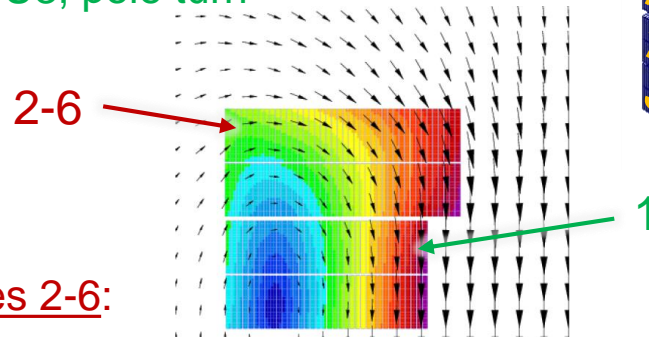

## Quenches 2-6:

9.4-9.9 kA

11.7-12.2 T

CR3401, upper layer, low field area

Same pattern for all

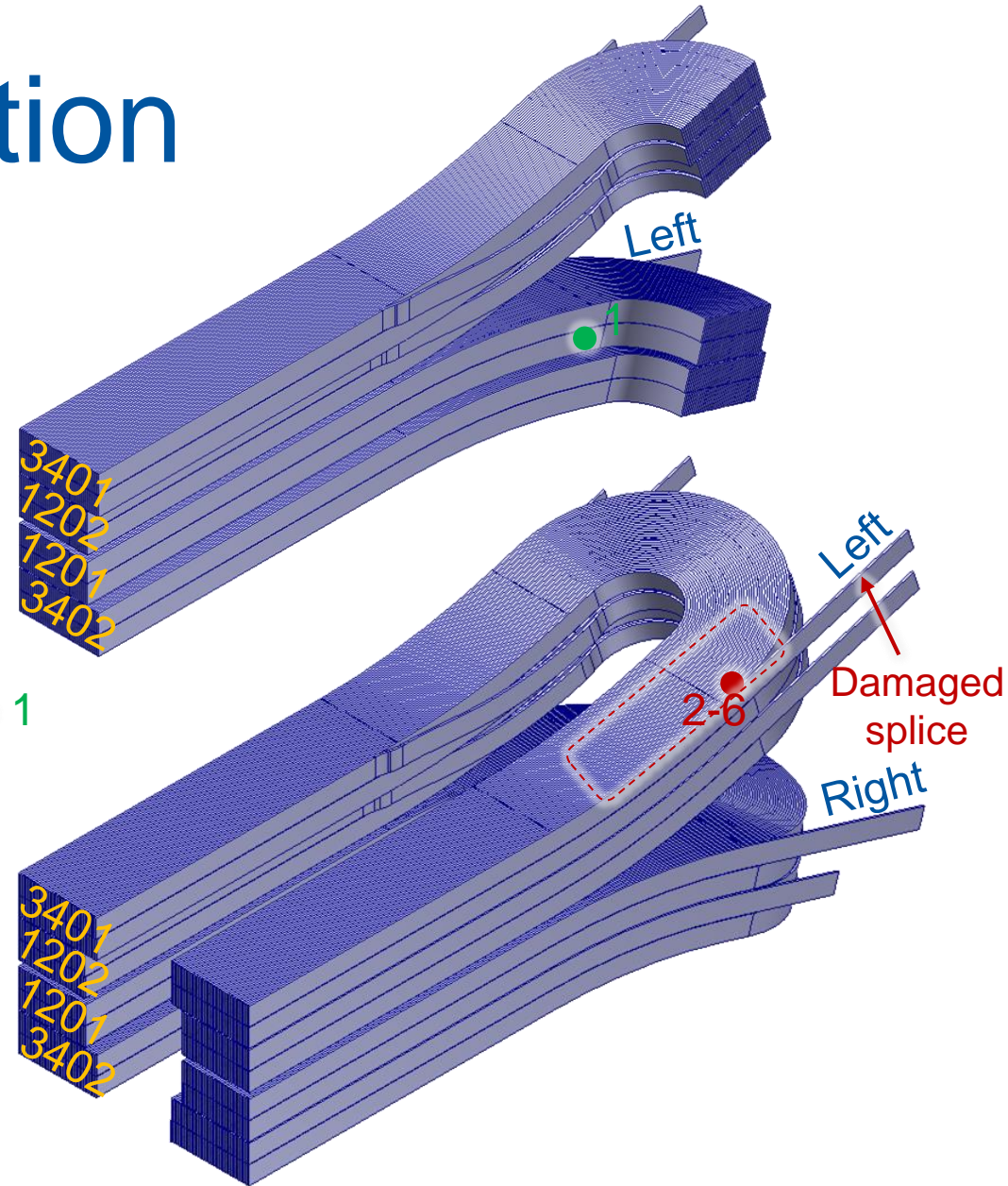

# Quench 2 - 6

[Gerard Willering, TE-MS-C-TF]

Reproducible pattern:

1. Precursor 25 ms before the quench  
→ 2 and 6 show strong perturbation (possibly motion)

2. Quench starts ( $t = 0$ )

3. Perturbation in the splice

4. Quench in the splice

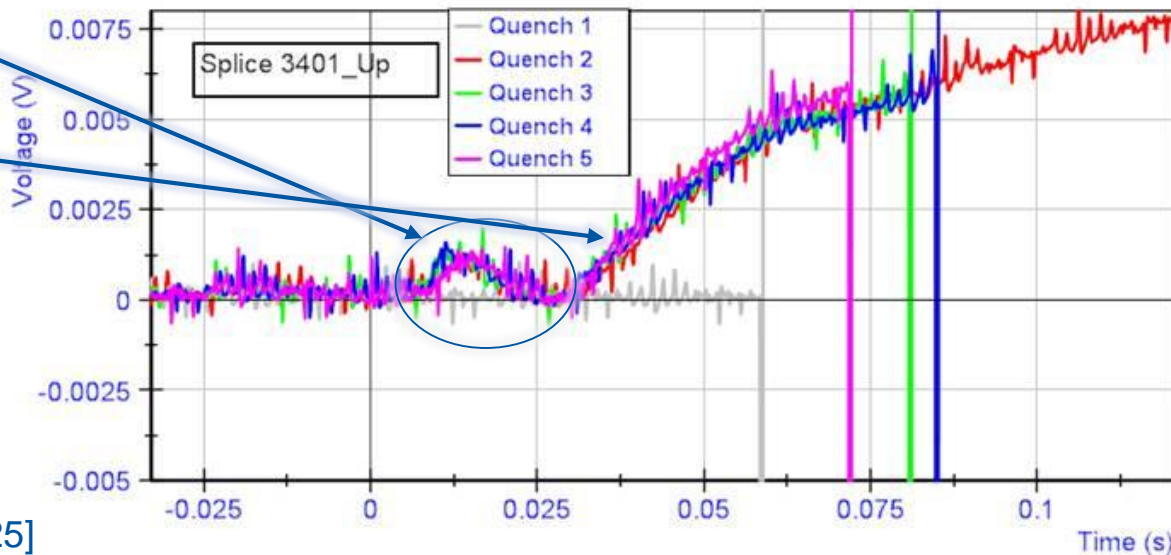
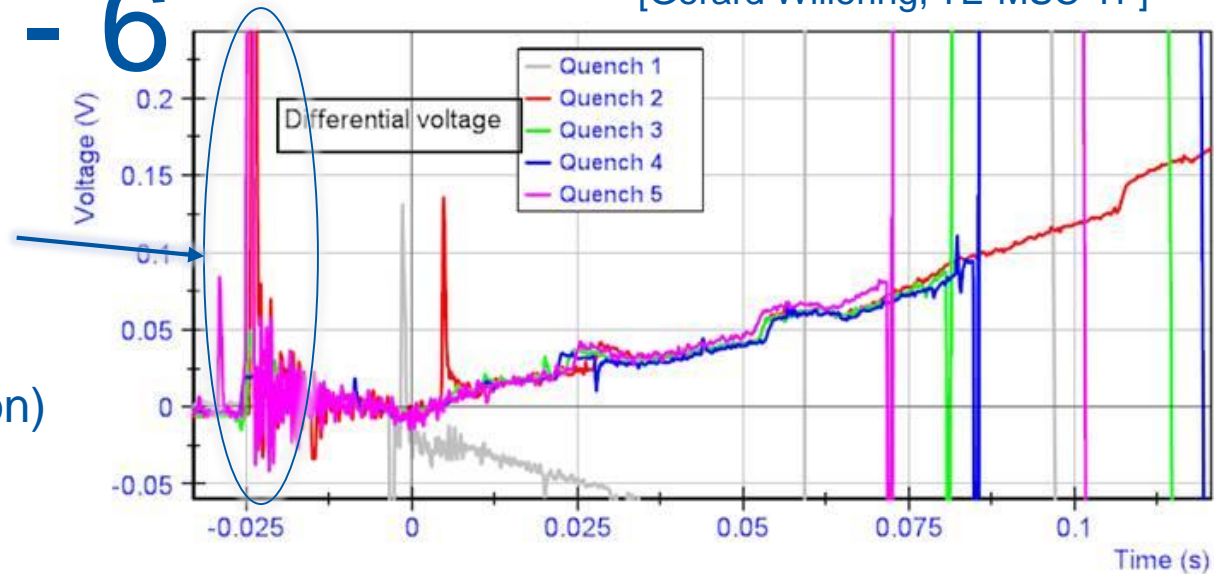

More details coming in [G. Willering et al., "Results of the cold powering tests of the Nb<sub>3</sub>Sn FRESCA2 block coil magnet", MT25]

# Quench heater circuit failure

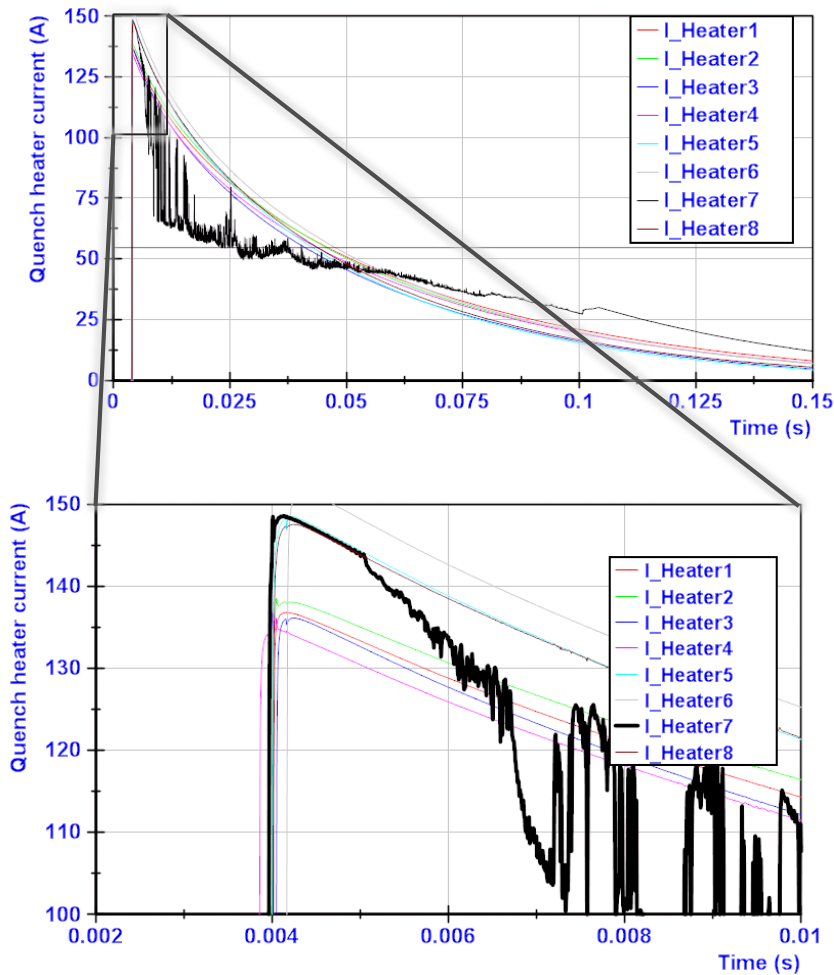

- At the ramp after quench 6 the protection tripped.
- 1 ms after heater discharge start the heater circuit failed.
- In all previous discharges no anomalies, no precursor for failure.

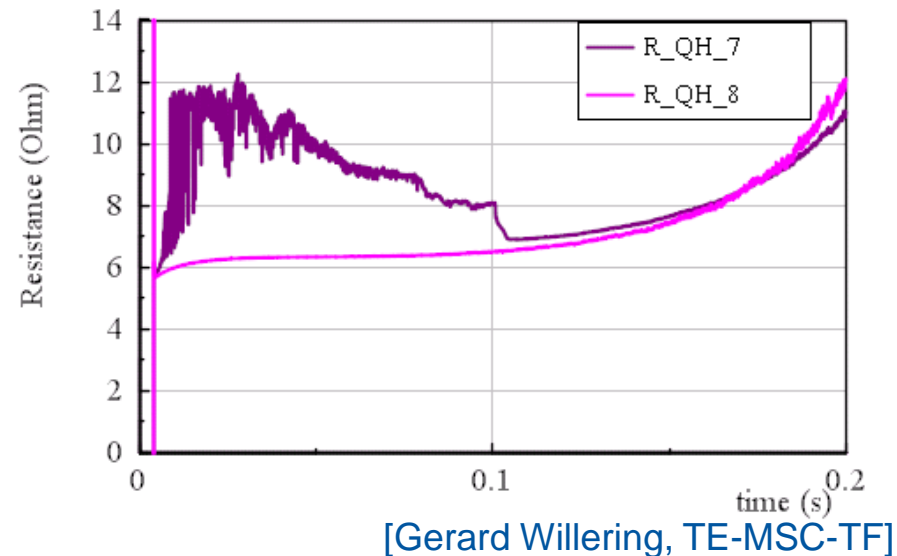

[Gerard Willering, TE-MS-C-TF]

# Quench heater circuit failure

- Continuity measurement
  - Reflectometry
  - 4-point measurement
- **Tests stopped**
- **3401 will be replaced**
- } Turn 22, 70 % of coil from upper splice  
→ Corresponding to the location of a 'bubble'  
→ **Risk of a turn-to-turn short**

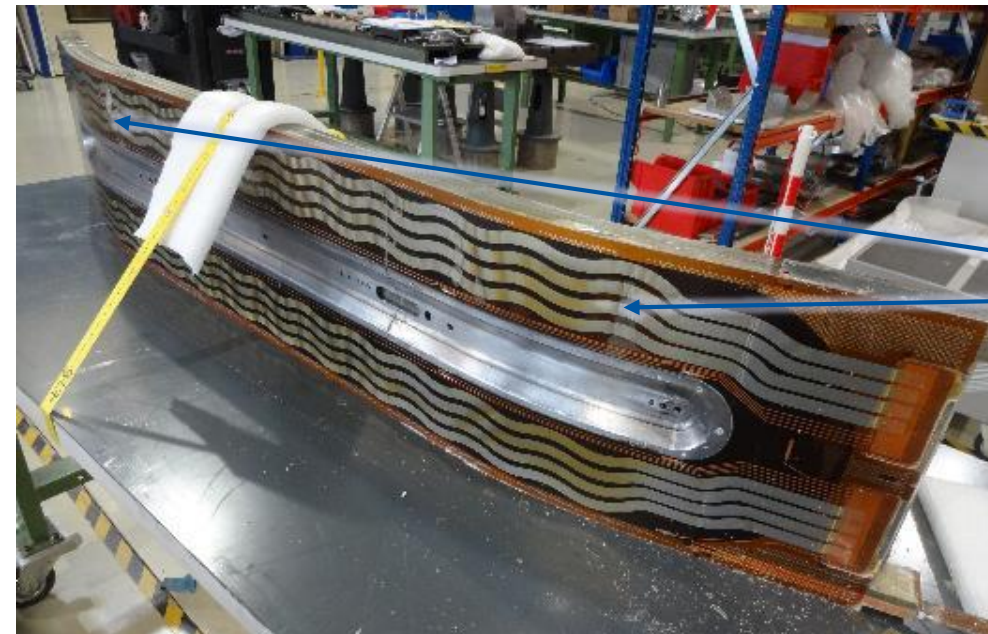
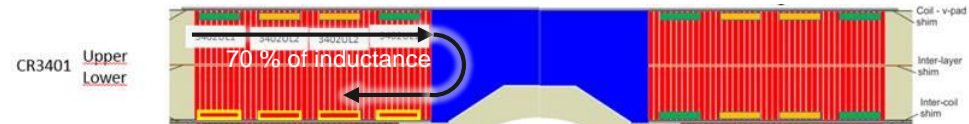



# 5. Magnetic and Mechanical Analysis

# Bore field

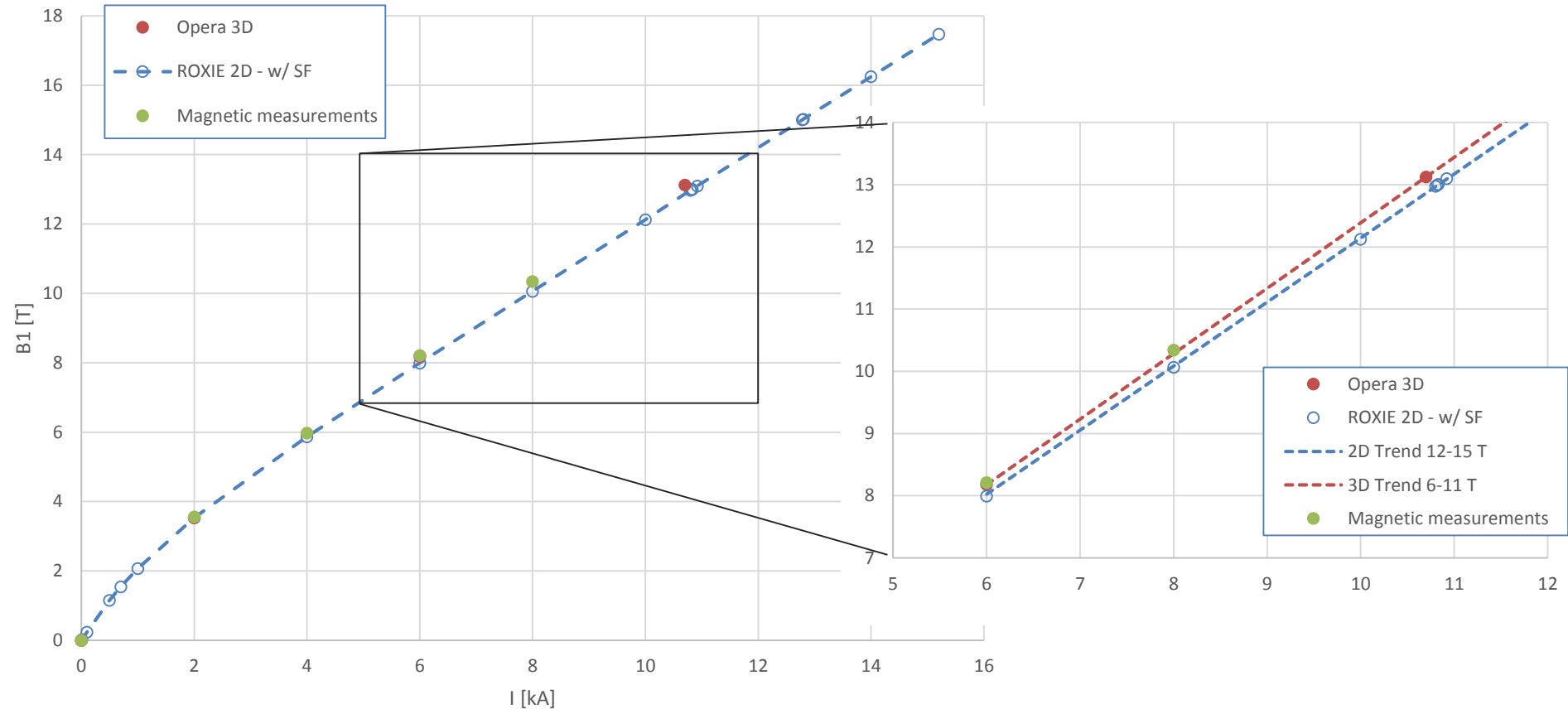

- Field measured with rotating coils
- Validation of 3D magnetic model with Magnetic measurements

[C. Petrone, TE-MS-C-TF]

# Strain on the shell

Data from [P. Grosclaude, TE-MME-EDM]

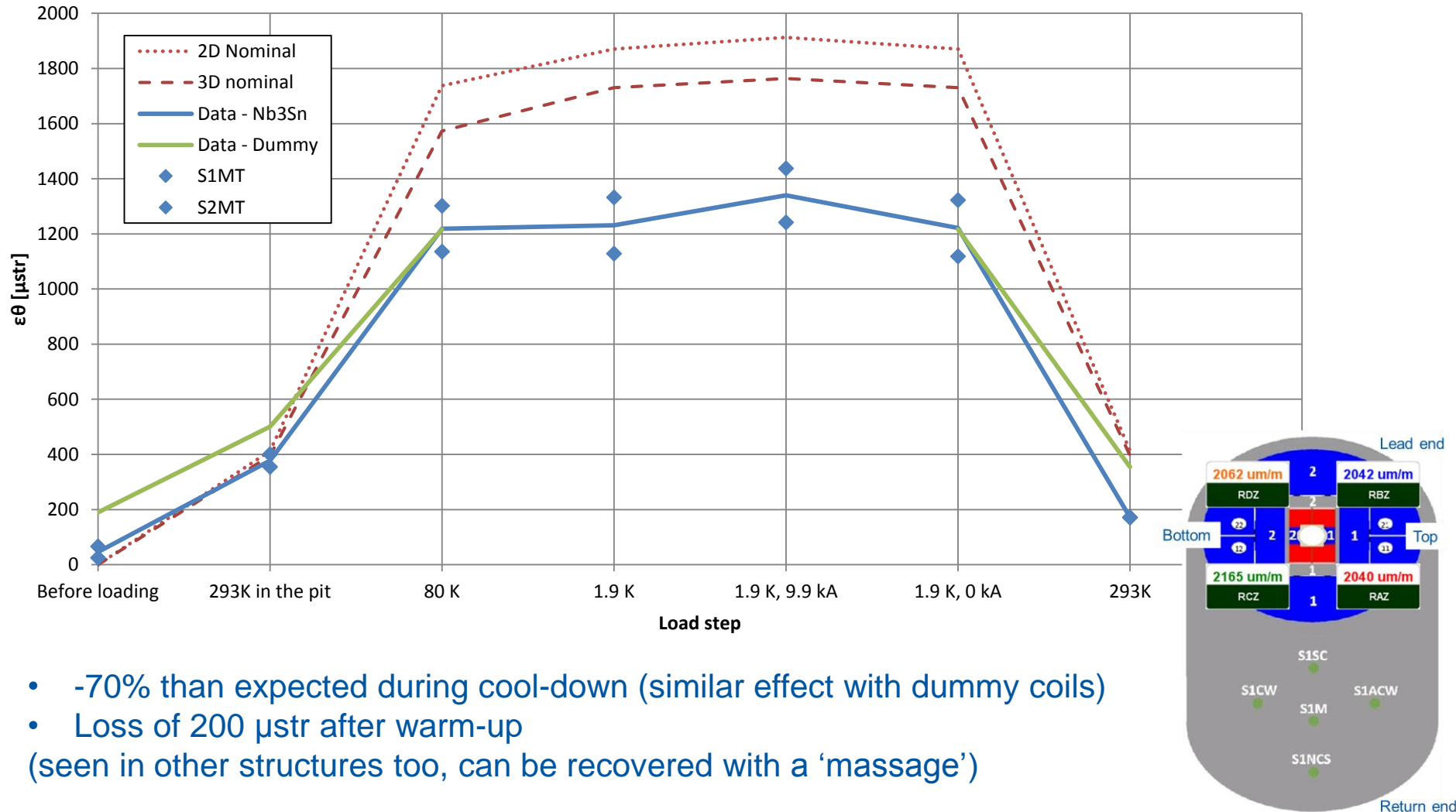

- -70% than expected during cool-down (similar effect with dummy coils)
- Loss of 200  $\mu\text{str}$  after warm-up  
(seen in other structures too, can be recovered with a 'massage')

# Strain on the poles

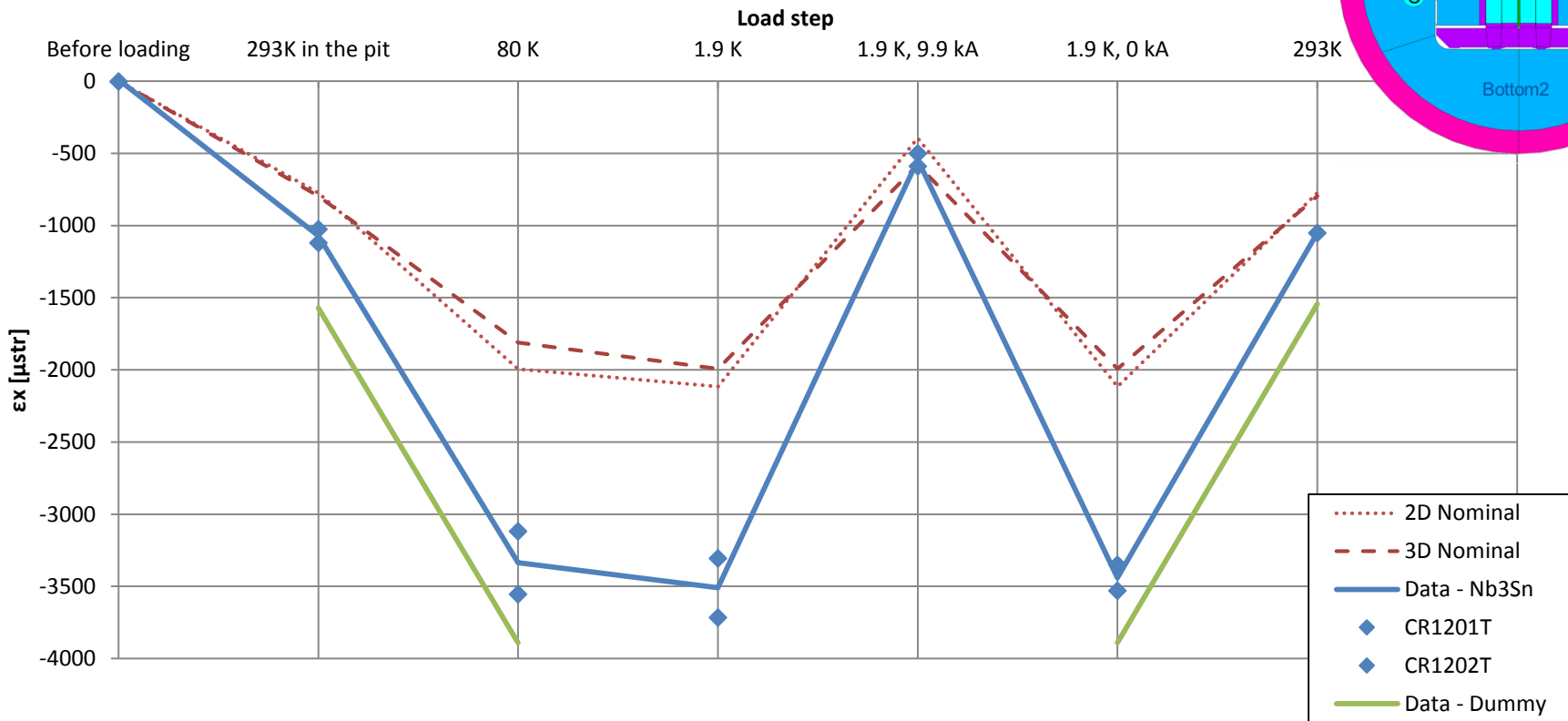
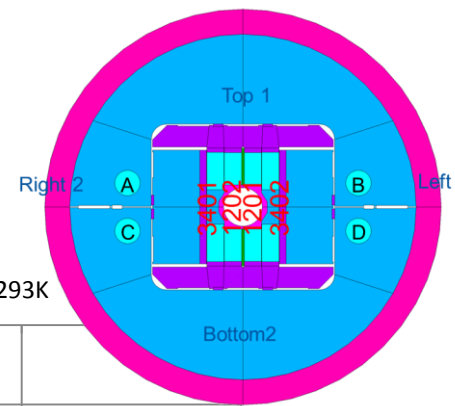

- +130% than expected during cool-down (similar effect with dummy coils)
- No loss after warm-up

Data from [P. Grosclaude, TE-MME-EDM]

# Update of the model

- Un-explained difference during cool-down
- Already observed with the dummy coils
  - **intrinsic behavior of the structure?**
- 2D Parametric study to understand the difference between model and data

Parameter	Range	Impact on shell strain	Impact on pole strain	Final value
Coil young modulus	40 → 20 GPa	10 %	0 %	40 GPa
Contraction coefficient	3.36 → 3.90 mm/m	5 %	0 %	3.36 mm/m
<b>Friction coefficient</b>	<b>0.2 → 0</b>	<b>40 %</b>	<b>30 %</b>	<b>0 yoke-shell</b>

- **Is 0 friction between yoke and shell realistic?**
  - Already seen in the past
  - Effect probably more complex to model than just linear friction

# Update of the model

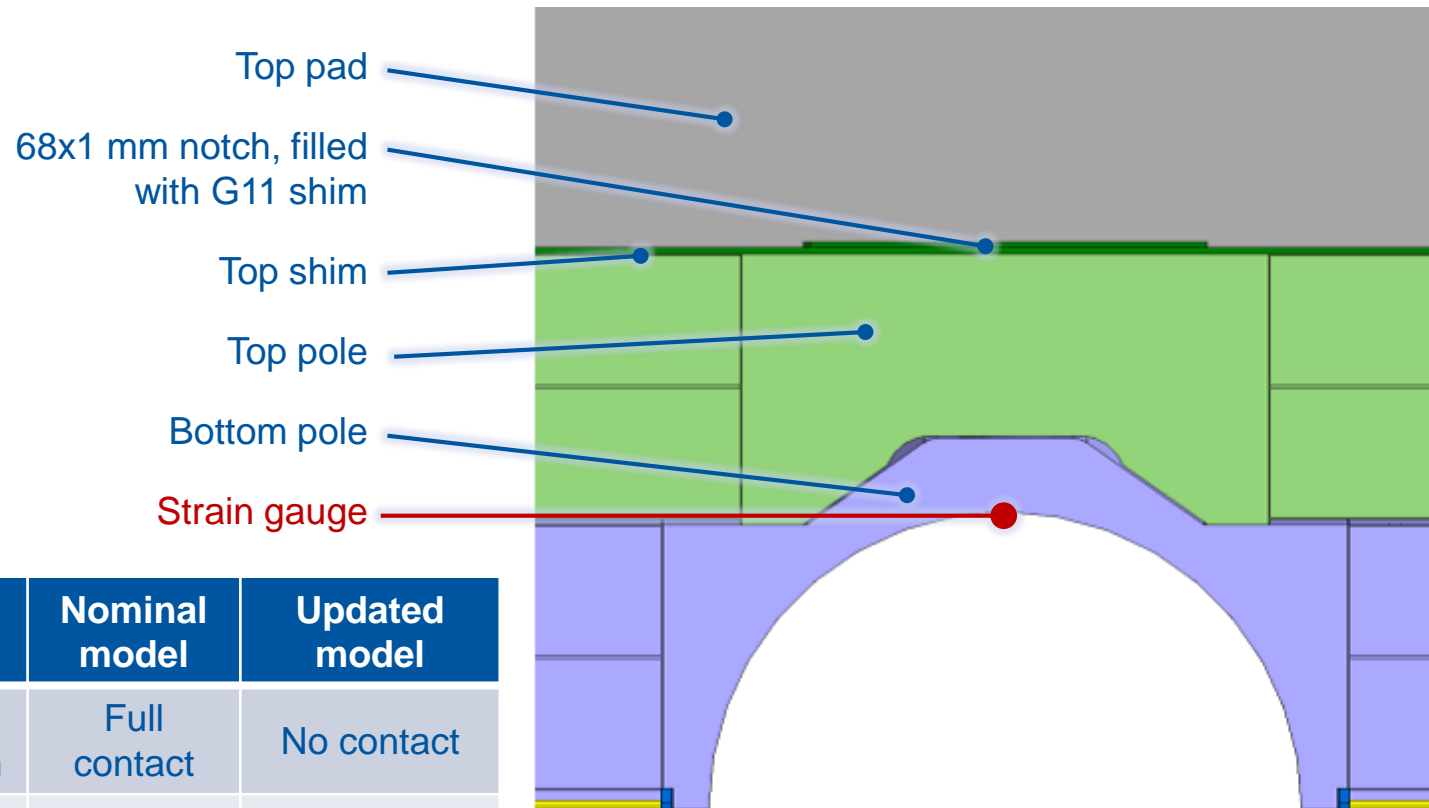

Contact	Reality	Nominal model	Updated model
Top pad – top pole	Notch with shim	Full contact	No contact
Top pole – bottom pole	Gap filled with resin	Full contact	Gap filled with resin

- Less vertical contact allows more bending in the bottom pole
- Marginal impact on the coil peak stress

# Strain on the shell

Data from [P. Grosclaude, TE-MME-EDM]

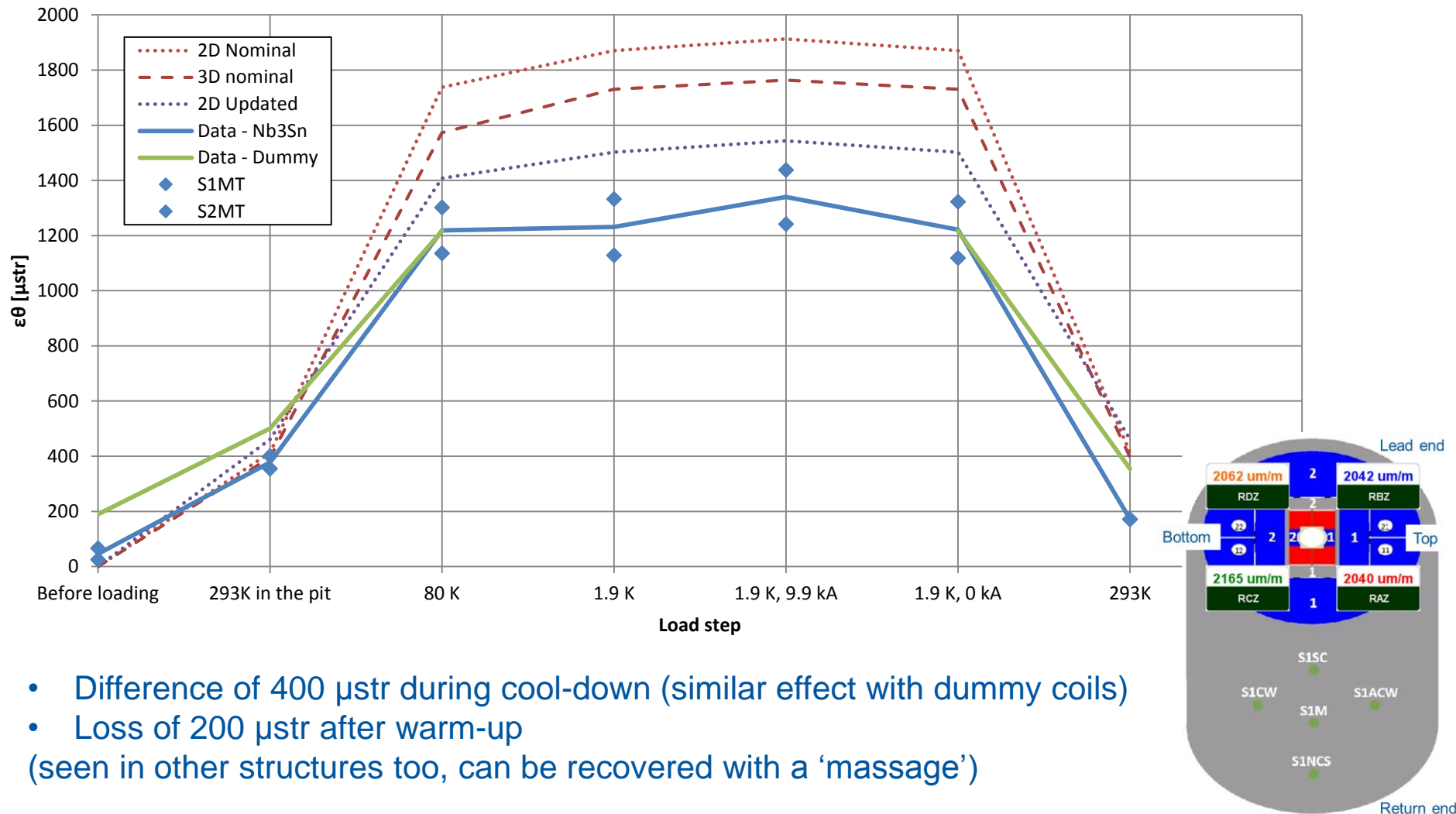

- Difference of 400  $\mu\text{str}$  during cool-down (similar effect with dummy coils)
- Loss of 200  $\mu\text{str}$  after warm-up (seen in other structures too, can be recovered with a 'massage')

# Strain on the poles

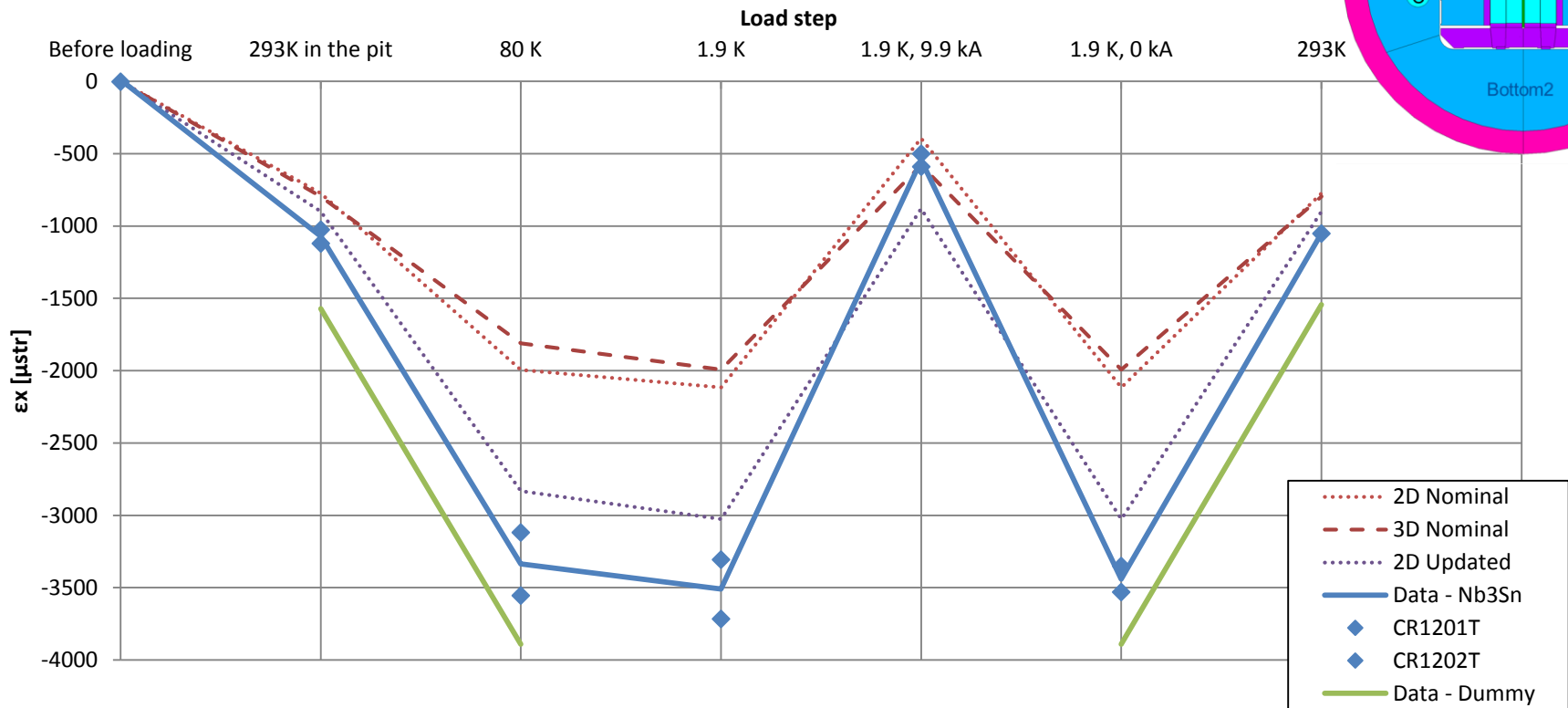

- Difference of 1500  $\mu\text{str}$  during cool-down (similar effect with dummy coils)
- No loss after warm-up

Data from [P. Grosclaude, TE-MME-EDM]



# Strain on the rods

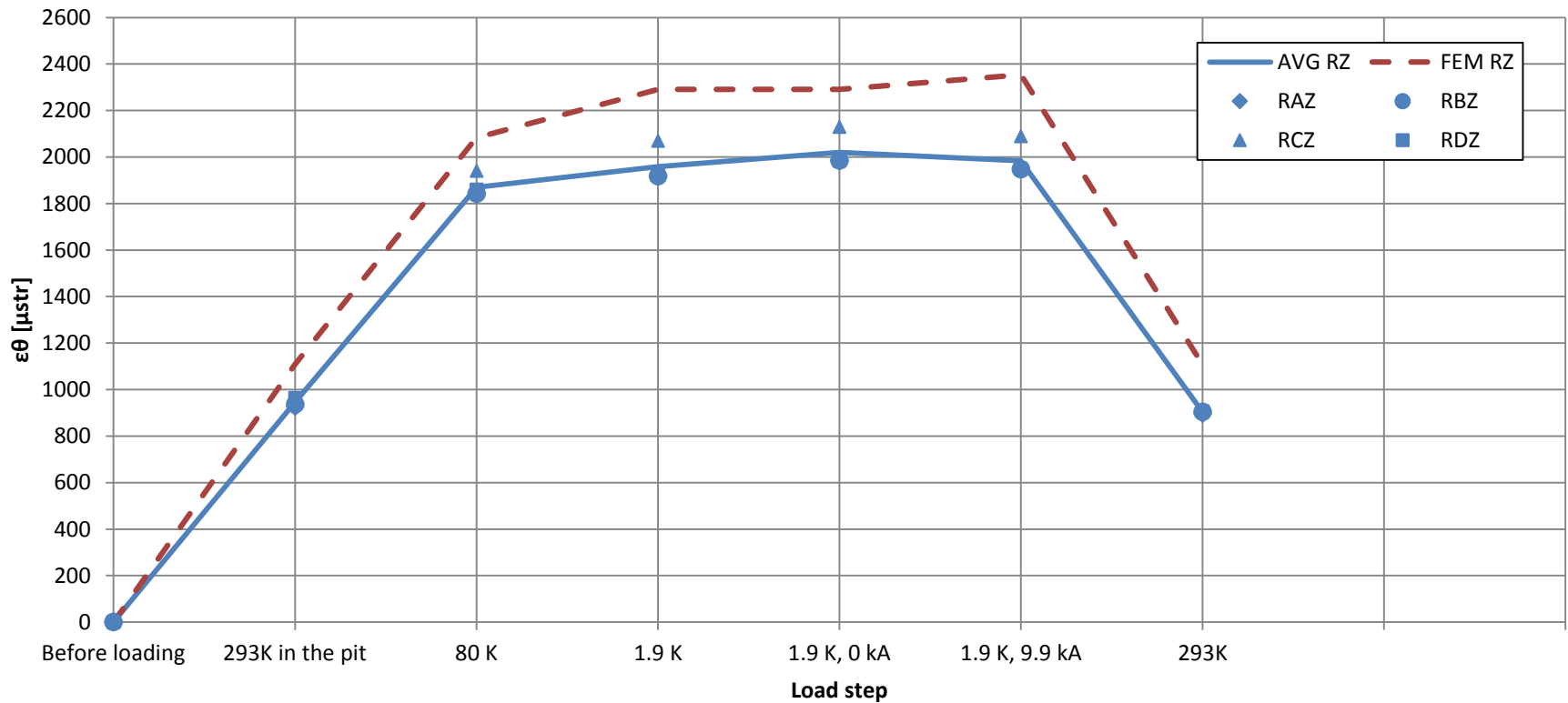

- Difference of 200  $\mu\text{str}$  during cool-down
- No loss after warm-up

Data from [P. Grosclaude, TE-MME-EDM]

# Shell

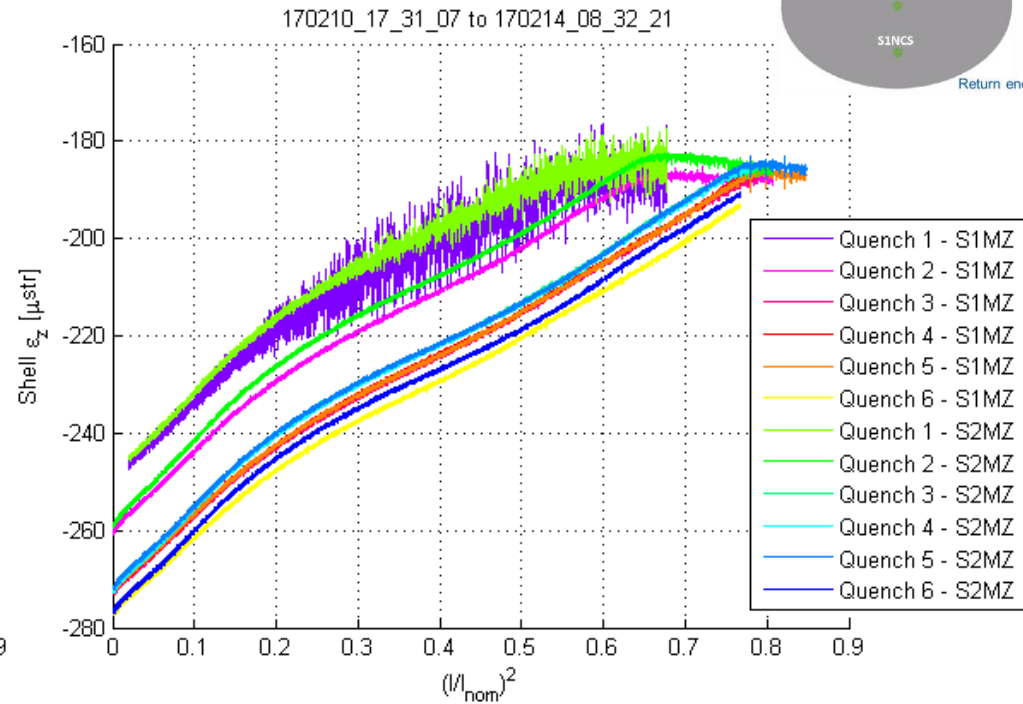
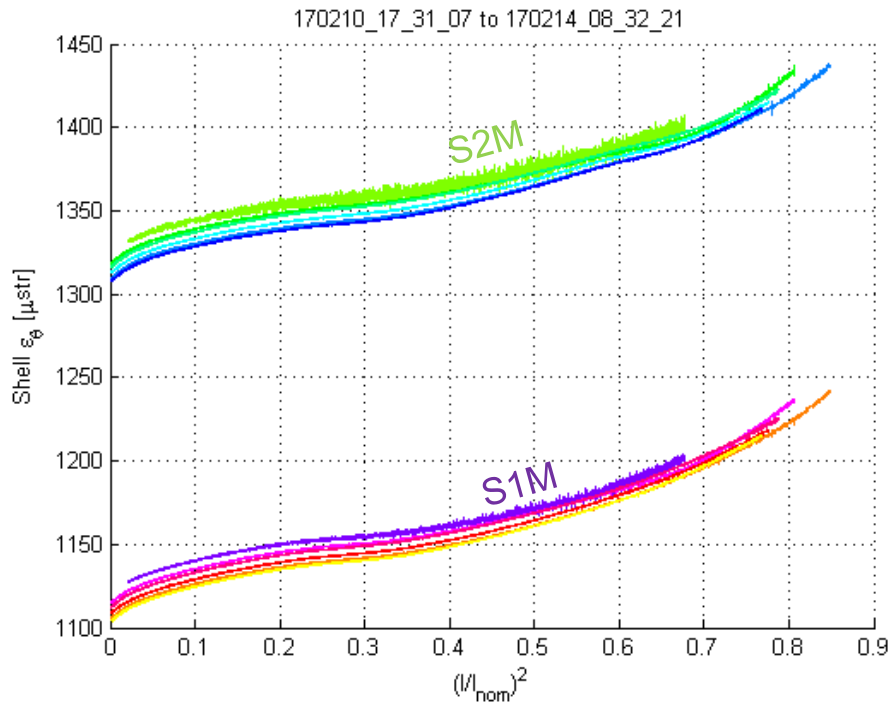
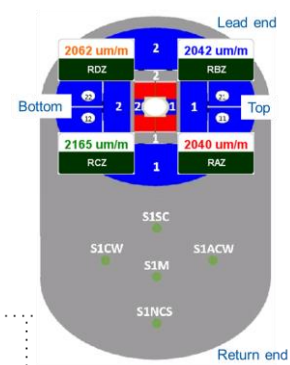

- Linear unloading with  $I^2$
- Difference left/right of 200  $\mu\text{str}$  (15%)

- Saturation at about -180  $\mu\text{str}$
- Loss of contact?
- Cycling effect (+30  $\mu\text{str}$  after 6 quenches)

# Poles

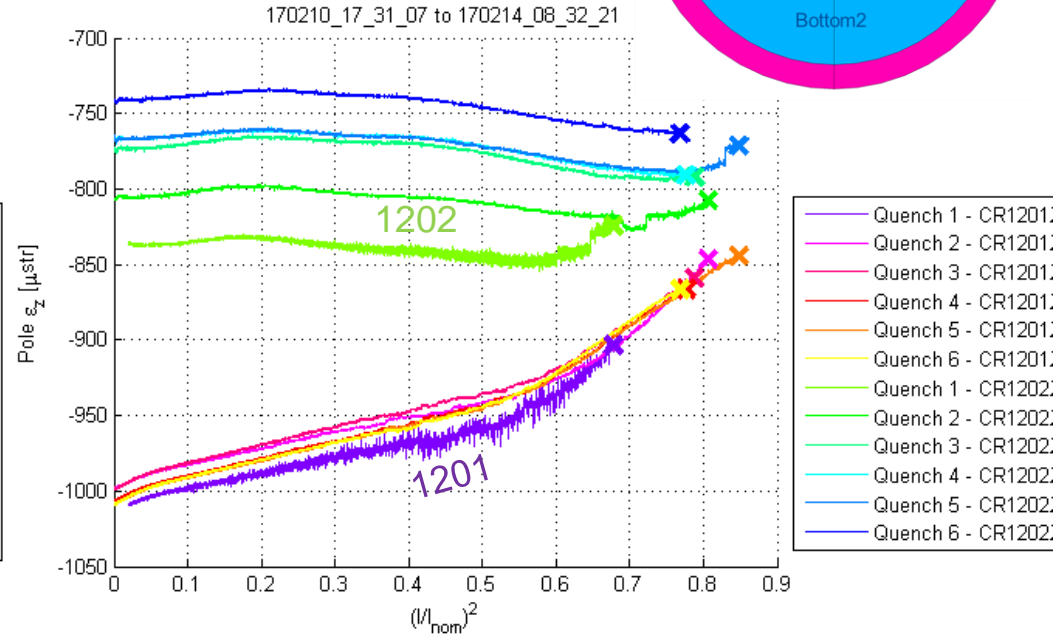
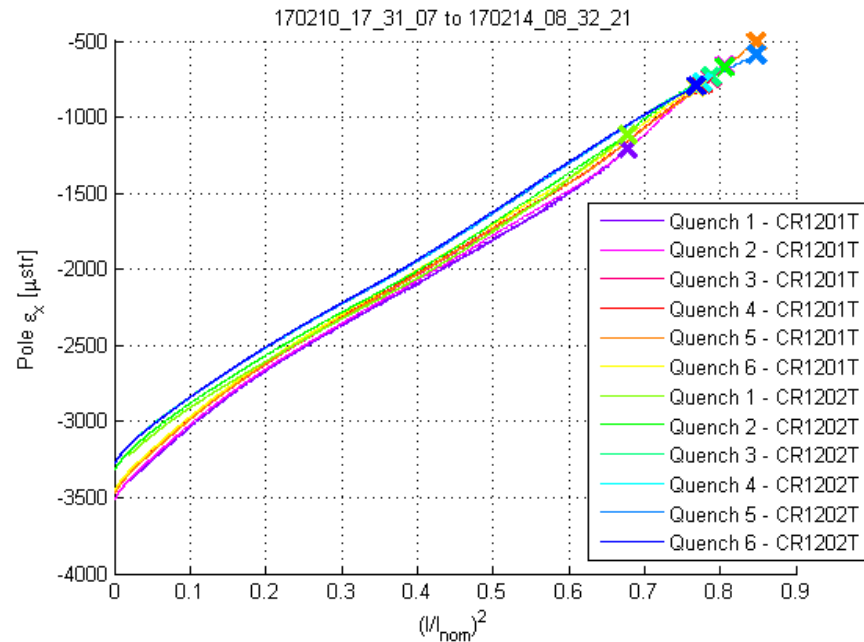
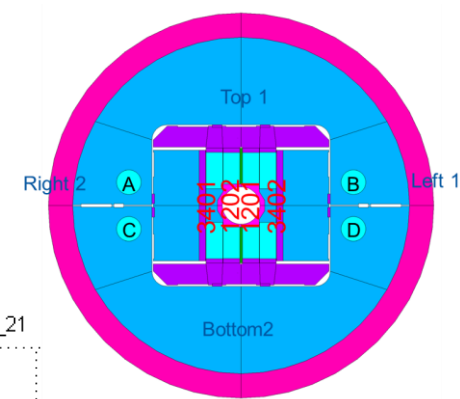

- Linear unloading with  $I^2$
- No cycling
- Balanced left/right

- Load on 1202 constant with current (as predicted by the model)
- Cycling (100  $\mu\text{str}$ )
- 1201 unloading
- Bending due to deformed pole?

# Rods

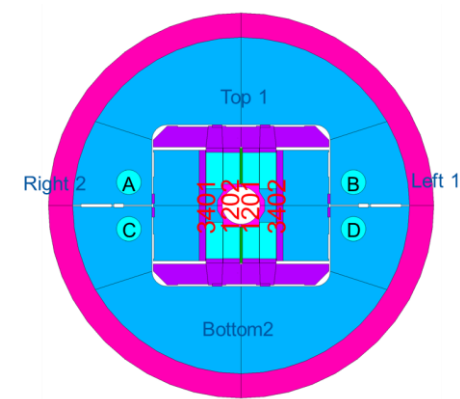
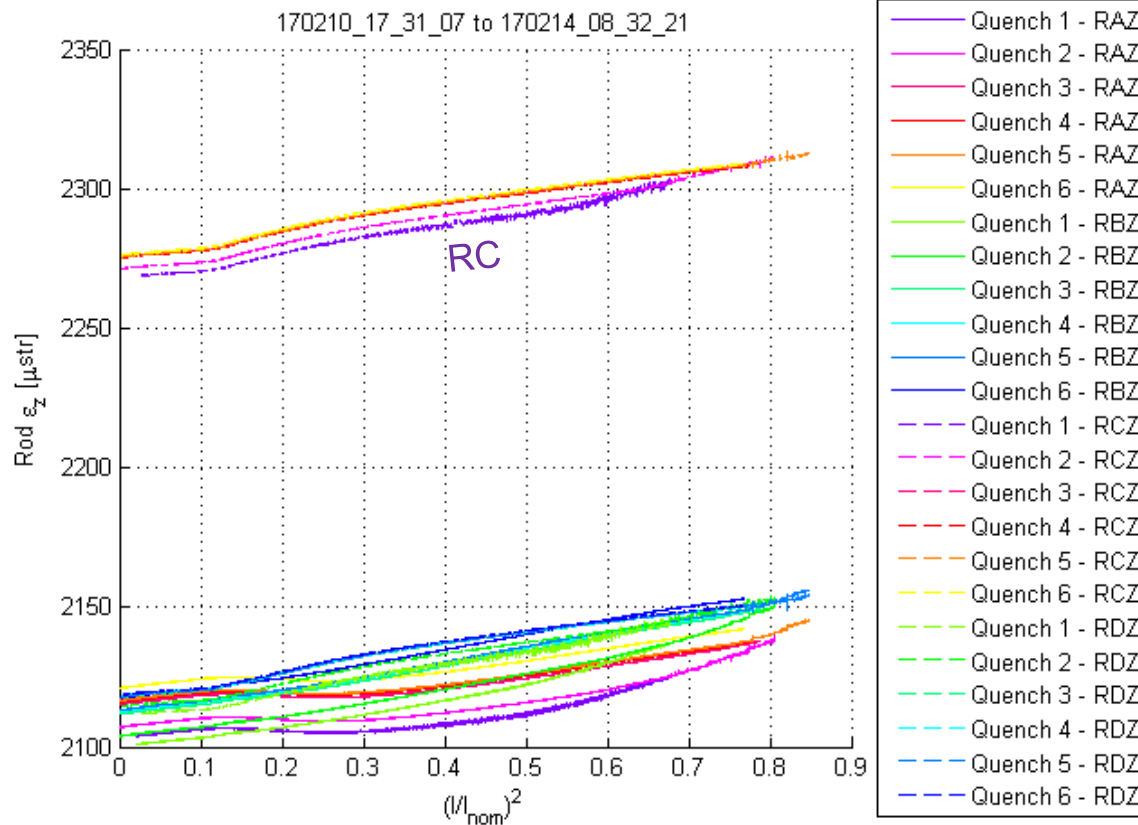

- Slight increase with  $I^2$  (predicted by the model)
- Negligible cycling (10  $\mu\text{str}$ )
- Rod C unbalanced (+170  $\mu\text{str}$ ) due to absence of counter-bolt

More details coming in [E. Rochepault et al., “Mechanical Analysis of the Dipole Magnet FRESCA2 During Assembly, Cool-Down and Training”, MT25]

# Summary

## 1. **FRESCA2 is not only a 13 T test station but also:**

- A proof-of-concept high field dipole
- A potential «outsert» to test HTS inserts and hopefully go to 20 T

## 2. **4 coils validated for the 1st assembly:**

- Issues encountered and some solutions found
- Procedures validated and adapted
- 3 spares (1 outer almost done + 1 inner on going + 1 outer waiting comp.)

## 3. **Magnet assembly successfully validated:**

- Validation of concepts with Cu coils and Al blocks
- Validation of assembly procedure

# Summary

## 4. 1st training campaign at 1.9 K:

- 6 quenches : 1 training quench at 11T + 5 'limited' quenches around 12 T
- QH failure → risk of a turn-to-turn short → Tests stopped
- Next step: dismantle the magnet, replace 3401 with 3403

## 5. Refining the models to better understand the behavior:

- Magnetic analysis: validation of loadlines
- Mechanical analysis: contact yoke-shell, contacts in the coil-pack

# Thank you for your attention!

Questions?

# Backup slides



# Variation of length during reaction

- Gaps introduced (B and C) before winding and manually closed
- Inner coils contract during HT → **All gaps close** (Ti poles)
- Outer coils do not contract during HT because of Iron poles → **Gaps open**

Coil	Step	Gaps [mm]				Coil Length [%]	End Thickness [%]		
		A	B	C	D		LE	RE	
Inner	CR1201	After winding	-	0	0	-	<b>0.38</b>	2.3	2.2
		After HT+impreg.	0	0	0	0	<b>0.19</b>	3.1	0.85
	CR1202	After winding	0.2	0	0	1.0	<b>0.24</b>	1.1	1.7
		After HT+impreg.	<b>0.1</b>	<b>0.1</b>	0	0	<b>0.15</b>	0.63	0.45
Outer	CR3401	After winding	0.8	0	0	0.8	<b>0.50</b>	4.3	3.8
		After HT+impreg.	<b>1.5</b>	<b>2.1</b>	<b>0.5</b>	<b>0.3</b>	<b>0.49</b>	<b>0.27</b>	<b>1.5</b>
	CR3402	After winding	0.2	0	0	0.7	<b>0.39</b>	3.4	3.4
		After HT+impreg.	<b>1.3</b>	<b>1.6</b>	<b>0.2</b>	<b>0.1</b>	<b>0.42</b>	<b>-0.11</b>	<b>0.12</b>
	CR3403	After winding	0	0	0	1.0	<b>0.52</b>	0.25	3.4
		After HT+impreg.	<b>0.8</b>	<b>0.8</b>	<b>0.6</b>	<b>1.1</b>	<b>0.56</b>		

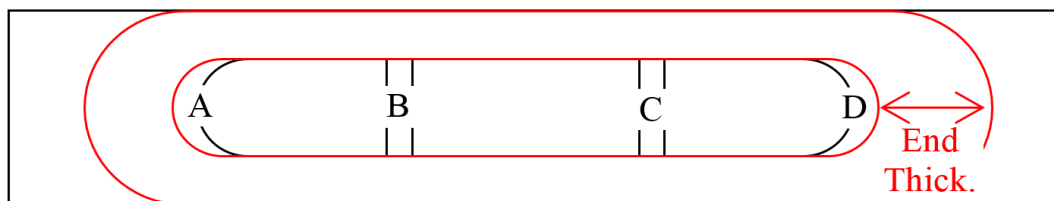

# Pole deformation during reaction

- CR1201 (1<sup>st</sup>): **Pole deformed during heat treatment** because of cable transverse expansion
- Adaptation of the impregnation mould + fiber-glass shims to fill the space
- **Pole re-machined** after impregnation
- **Next inner coils reacted with fillers** placed in the cavity

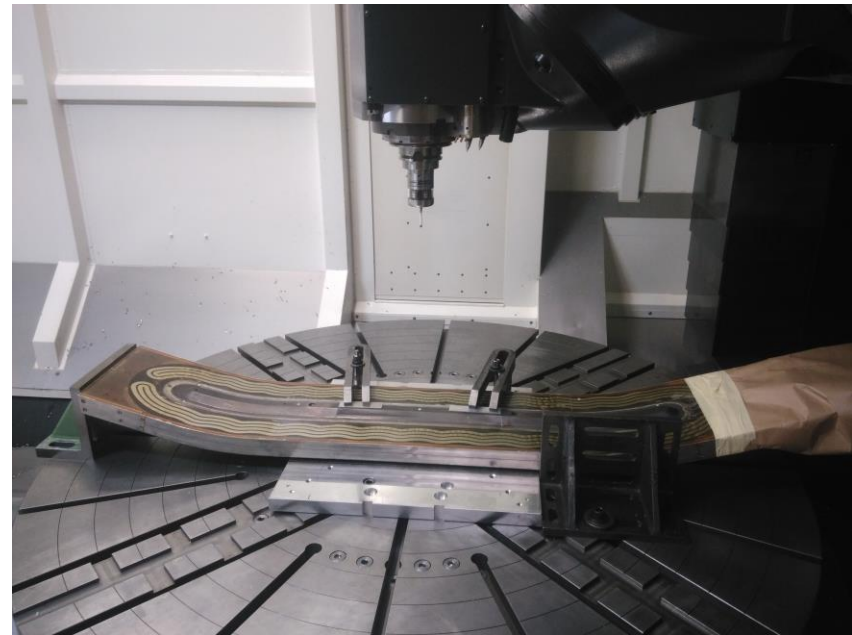
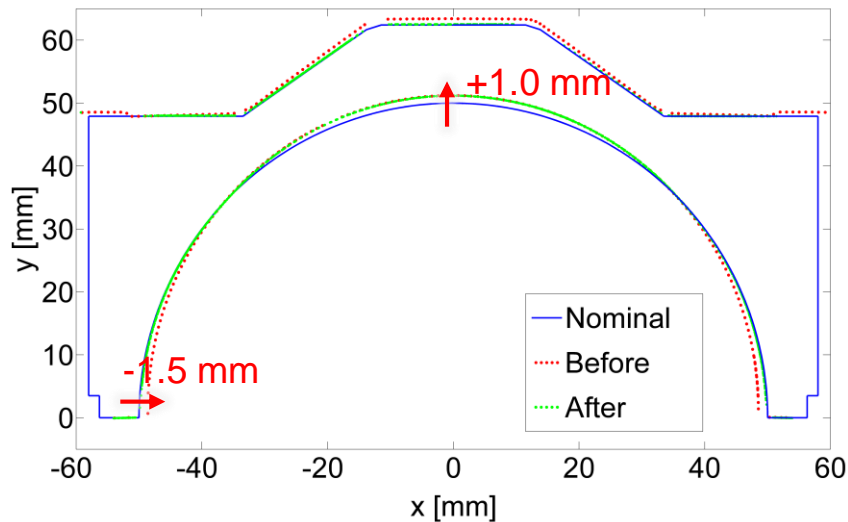

# Impregnation issues

- Coils CR1201 and CP3403: **the resin did not go through**
  - CR1201: premature polymerization
  - CP3403: insufficient injection
  - **New injection holes** in the mould for 2<sup>nd</sup> impregnation
  
- Coil CR3401: **superficial bubbles**
  - Air trapped in the pole cavity
  - **Local injections of resin**
  - **Next outer coils impregnated with fillers** placed in the cavity



# Electrical tests

- Resistance and inductance ok
- Dielectric tests:

	V [kV]	R [GΩ]			
		1201	1202	3401	3402
Coil to end-shoe	0.5	21/8.6	17/6.8	8.8/19	11/6.2
<b>Coil to pole</b>	<b>0.5</b>	<b>1.0e<sup>-3</sup></b>	<b>2.7e<sup>-4</sup></b>	<b>3.4e<sup>-3</sup></b>	<b>2.1e<sup>-3</sup></b>
Coil to QH	2.5	<b>1.8e<sup>-6</sup></b>	18	12	20
QH to end-shoe	1.5	12	42	17	43

- **Insufficient coil-to-pole insulation**
- Pole-to-pole insulation required
- Coil discharge ok
- QH discharge ok (except inner upper-layer QH of CR1201)

# Summary of coil fabrication

Bobine	Câble	Compo- sants	Bobinage	Réaction	Pré- Impreg.	Impreg.	Post- Impreg.	Tests elec.	Autres
CR1201	✓	✓	✓	Déf. post	✓	2 temps	✓	CC post, CC QH UL1	Usinage pole
CR3401	✓	✓	✓	✓	Splice	Bulles	✓	CC post	Ré-impr.
CR3402	✓	✓	✓	✓	✓	✓	✓	CC post	
CR1202	✓	✓	✓	✓	✓	✓	✓	CC post	
CR3403	✓	✓	✓	✓	✓	2 temps	✓		Ré-impr.
CP1203	✓	✓	✓	✓	✓				
CP3404	✓	En cours							

✓ Validé, RAS	En cours	Non-conforme, action corrective
---------------	----------	------------------------------------



# Tailored shim assemblies

- 1201+3402:
  - Space between the poles filled with resin
  - Excellent pole-to-pole electrical insulation ~100 GΩ up to 3 kV
- 1202+3401:
  - Space between the poles filled with resin
  - No electrical insulation: 430 kΩ
  - Coil-to-coil = 4.7 MΩ
  - Contact in the ends?

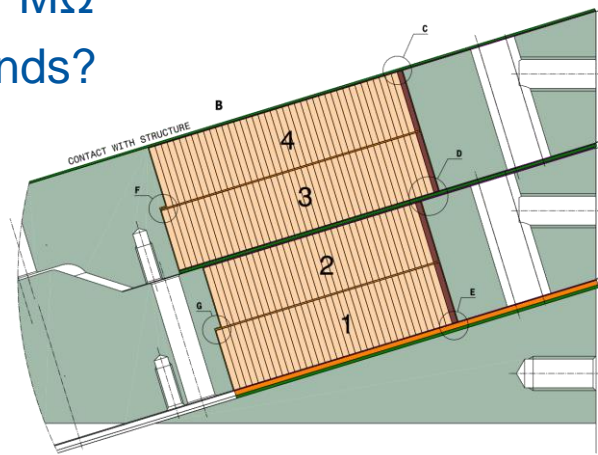

Pole-to-pole resistances:

	Test name		before imp	After imp
	U[test] [V]	time [s]	measured [GΩ]	measured [GΩ]
1201+ 3402	500	30	188.0	106.0
	1000	30	113.0	106.0
	1500	30	Brd	106.0
	2000	30	X	107.0
	2500	30	X	108.0
	3000	30	X	86.4
1202+ 3401	500	30	126.0	4.3e-6
	1000	30	82.8	X
	1500	30	Brd	X
	2000	30	X	X
	2500	30	X	X
	3000	30	X	X

# Assemblage 1201+3402

- 1201: surface supérieure bobine plus haute  
→ calage de l'espace dans le moule d'imprégnation dû à la déformation du post
- 1201+3401:  $0.9 - 0.6 - 0.3 = 0$  min. gap
- 1201+3402:  $0.9 - 0.6 - 0.2 = 0.1$  mm min. gap  
→ Plus favorable géométriquement

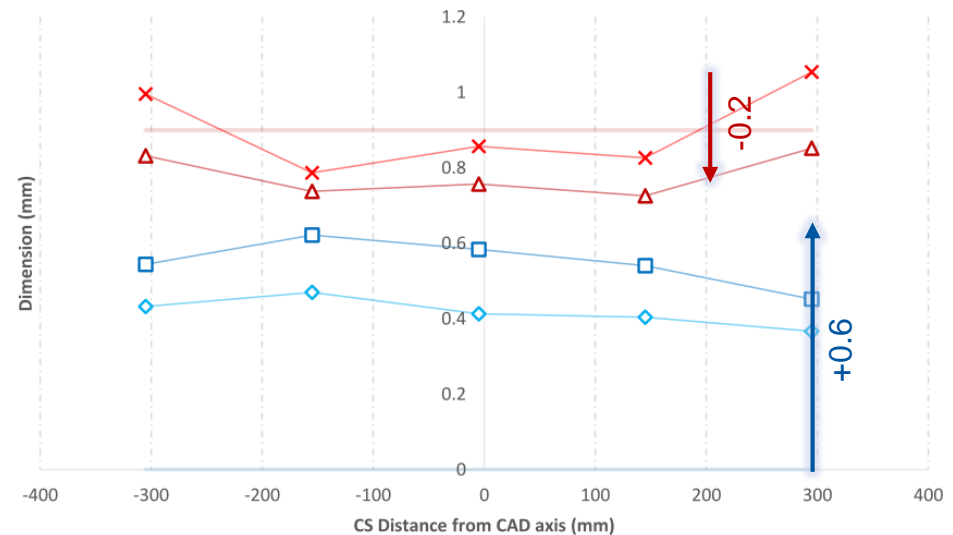
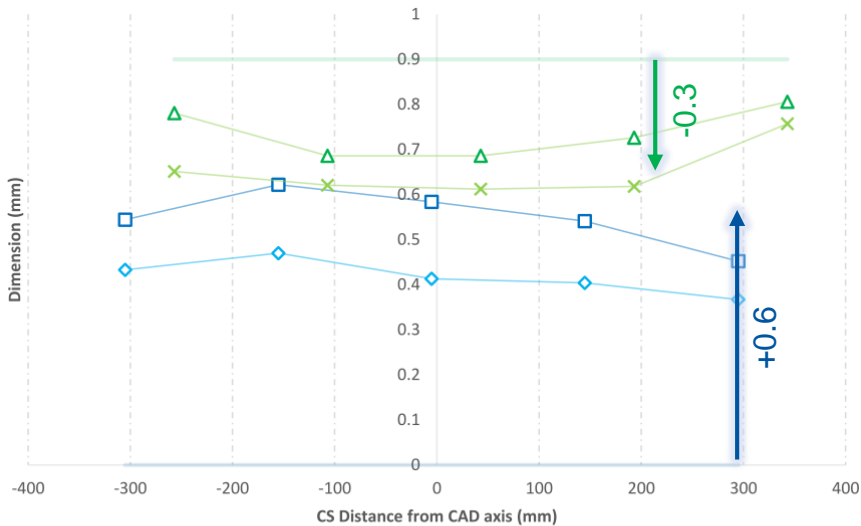
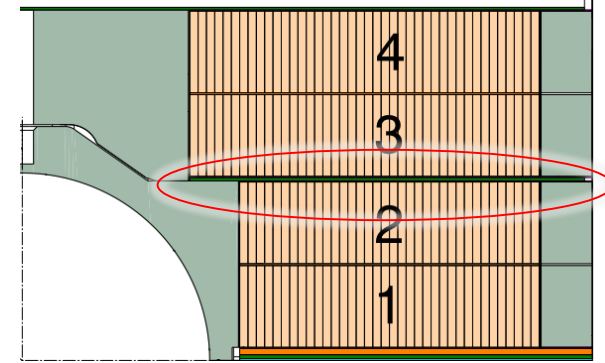

◆ 1201 Resin LJ    ■ 1201 Resin NLJ    × 3401 Resin LJ  
▲ 3401 Resin NLJ    — 1201 Nominal    — 3401 Nominal

◆ 1201 Resin LJ    ■ 1201 Resin NLJ    × 3402 Resin LJ  
▲ 3402 Resin NLJ    — 1201 Nominal    — 3402 Nominal

# Assemblage 1201+3402

- «Marche» observée entre le post central et les extrémités
    - Les posts touchent dans la partie droite des extrémités seulement
  - ~50  $\mu\text{m}$  de jeu entre les posts centraux
    - Remplis par la tailored shim
  - Gaps estimés (cales):
    - 0.3 mm moyen gauche
    - 0.6 mm moyen droite
    - 0.45 mm moyen G/D
    - +0.25 mm marge dans les têtes
    - = 0.7 mm calage dans les têtes
- Cohérent avec mesures bras Faro

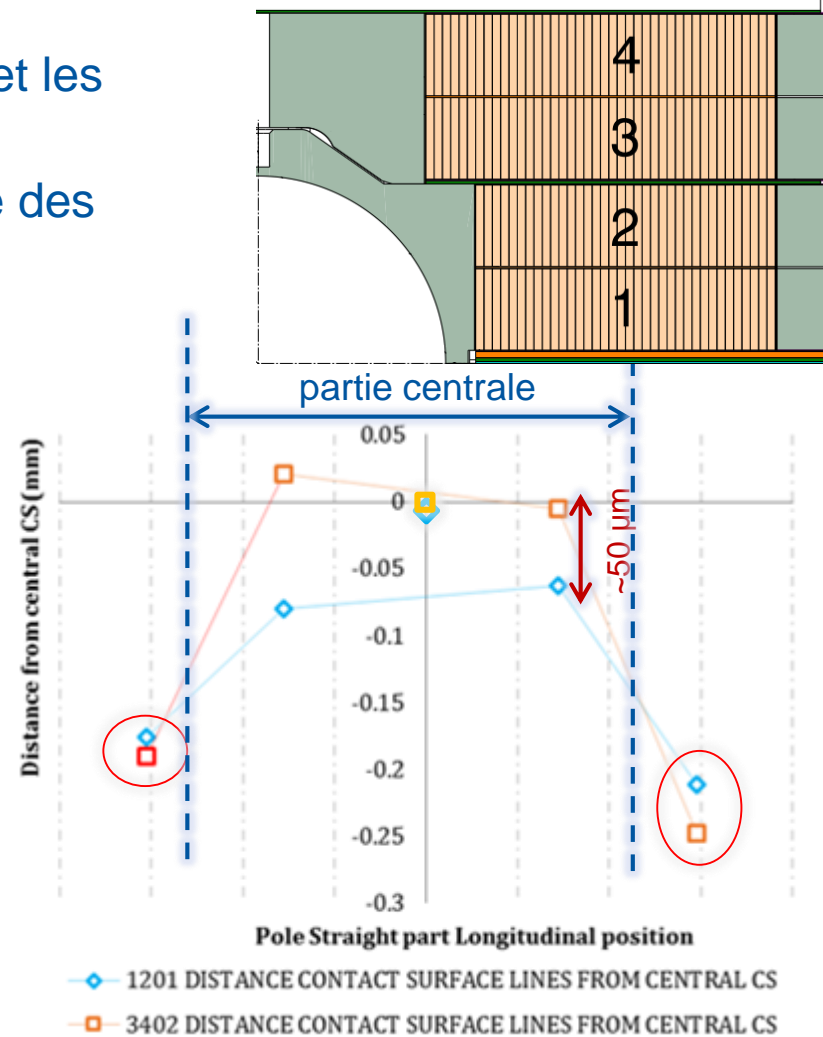



# Problème appro. wedges

- Résultat AO:
  - 1 wedge prototype puis,
  - 3 wedges sous réserve validation proto
- Entreprise en retard sur prototype (les 4 pièces demandées pour fin Sept)
  - Prototype reçu 17/10
  - endommagé pendant transport
  - En attente de métrologie
- 3 wedges restants démarrés pour gagner du temps
  - Ébauche en cours
  - Finition prévue à partir du 24/10
  - Livraison? Pas avant Mi-Nov.



# Pre-load for 15 T

Target: 20 MPa average coil-pole contact

→ **Preloads: 1.0 mm horizontal + 2 mm axial**

☑ Marginal tension and gaps

☐ Peak stress < 200 MPa during operation

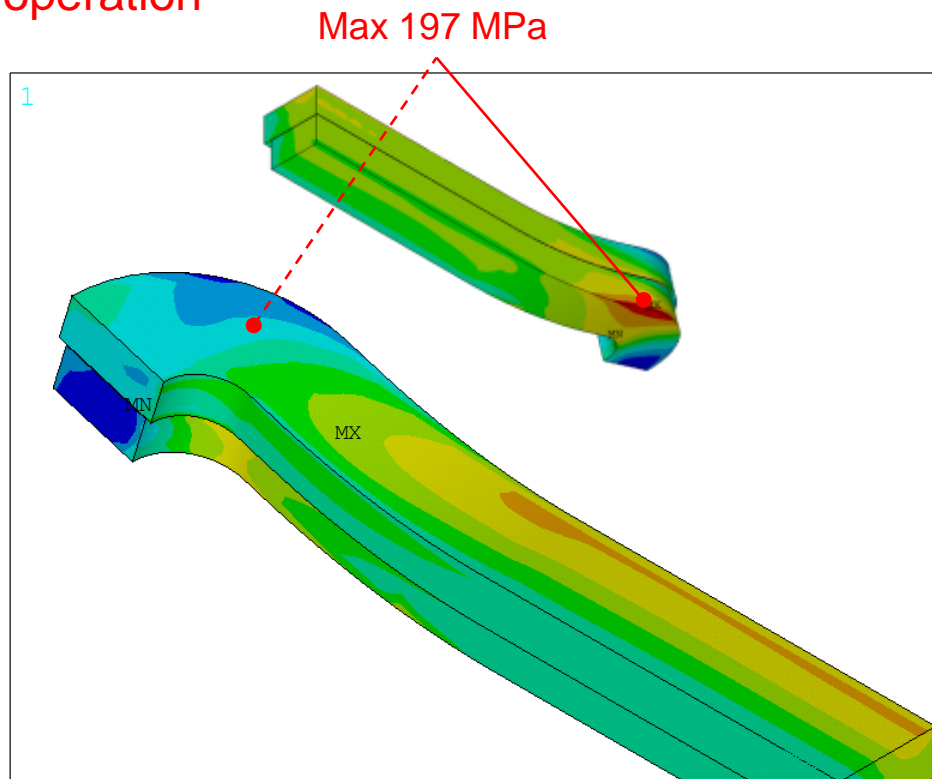
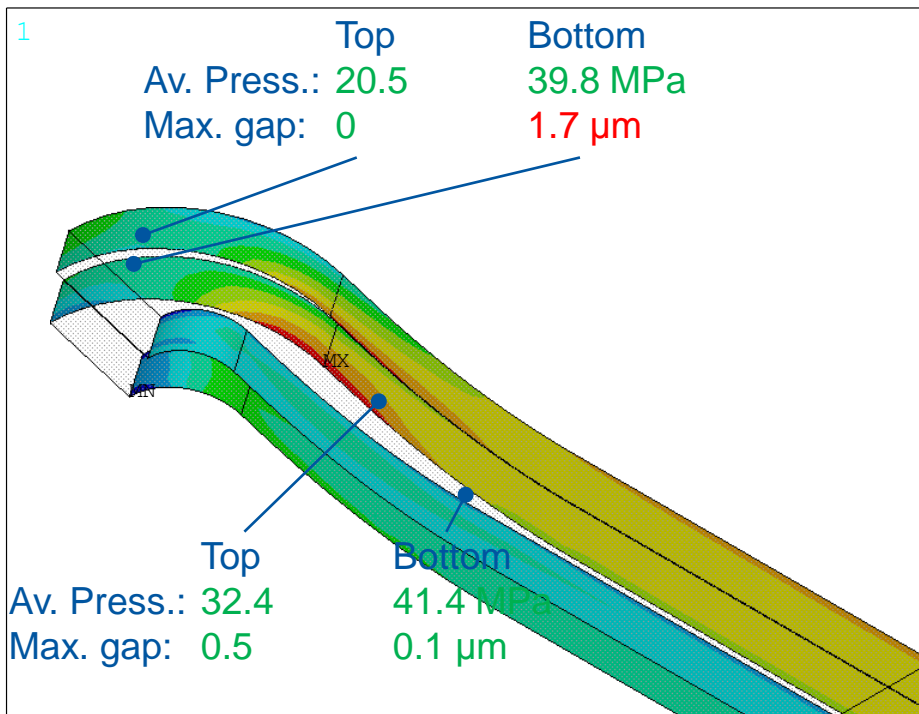

# Magnet test plan

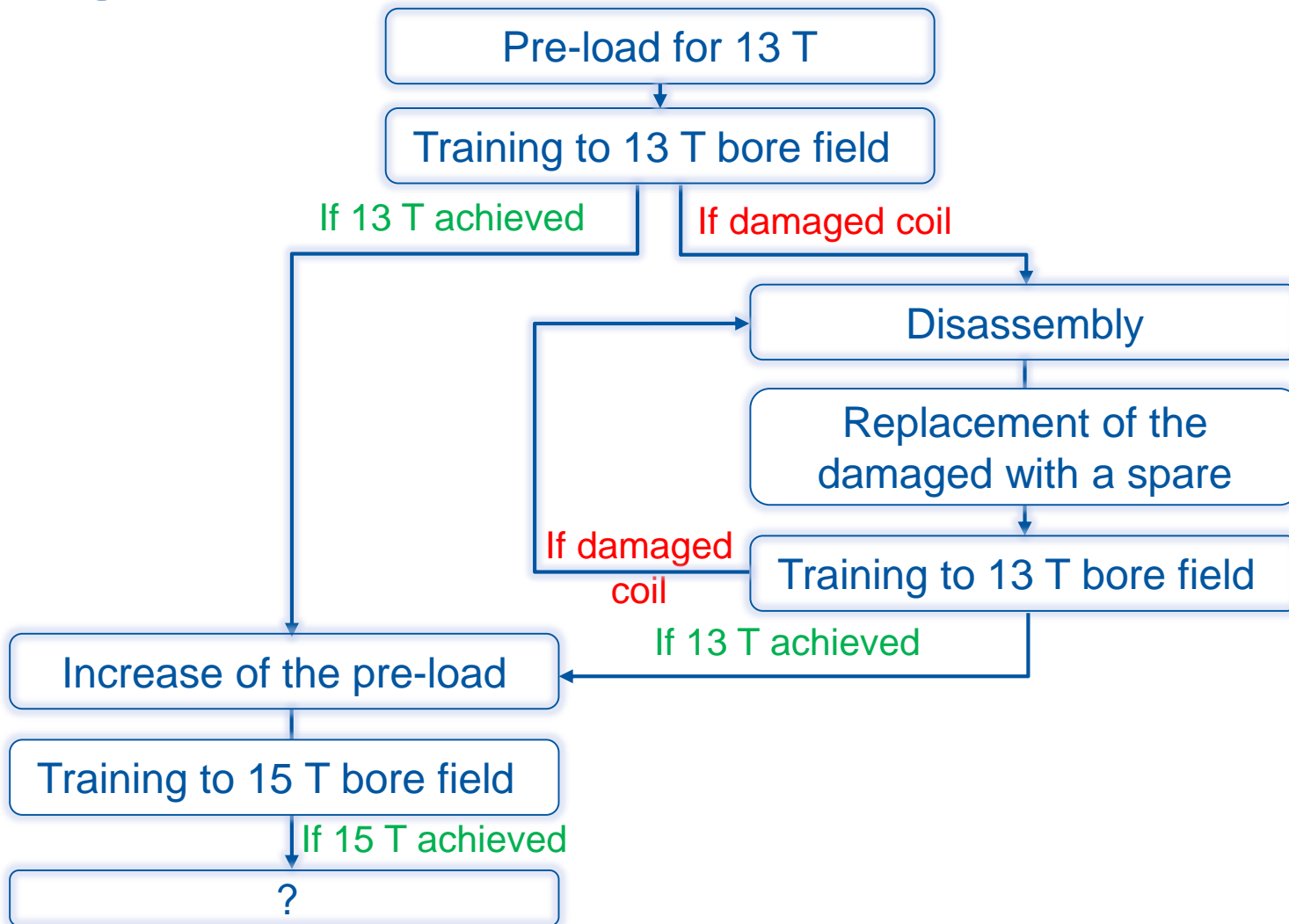

# Cooldown

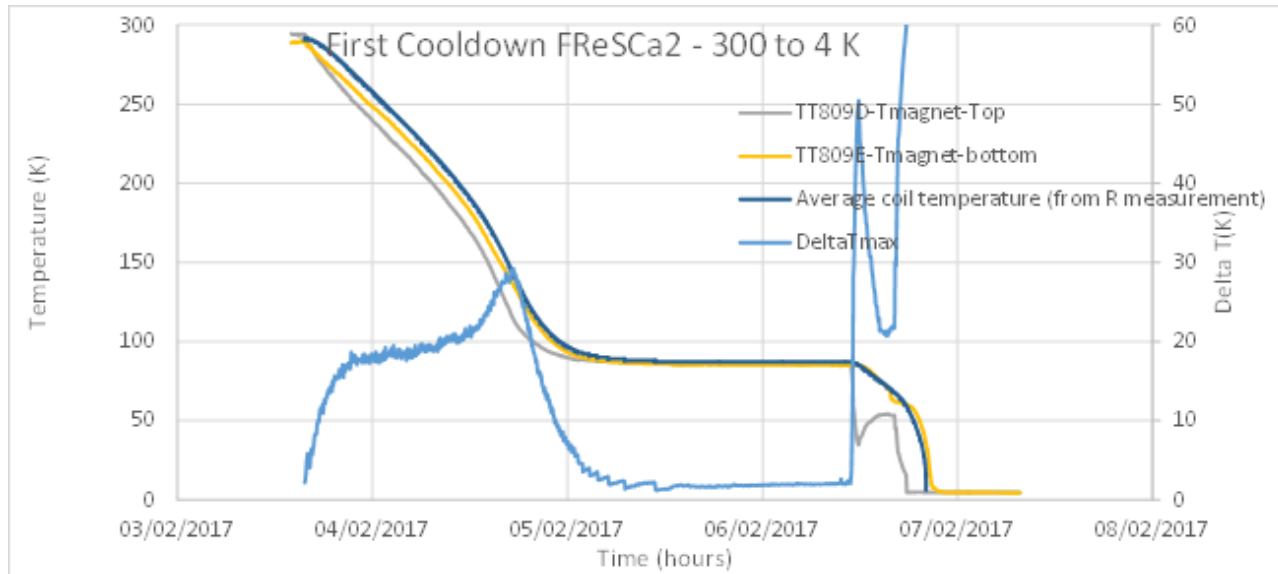

Fast cooldown with homogeneous temperatures.

Maximum 30 K temperature difference between outside of the shell and the coil.

# RRR

The resistance at transition was measured very accurately during slow warm up.

	$RRR_{293K/20K}$	$RRR_{293K/4K}$	Extracted strand average $RRR_{293/20K}$	Expected value for cable $RRR_{293K/20K}$
All coils combined	285	336		
Coil 3401	293	346	276	150
Coil 1202	243	287	224	190
Coil 1201	266	314	224	191
Coil 3402	285	336	164	164

Strand data and expected values from internal notes by B. Bordini et al.

## Reminder of RMC data:

$RRR_{280K/20K}$  was average 199 for the cable

$RRR_{293/20K}$  was between 80 and 160 for extracted strands.

For both RMC and FRESCA2 the coil RRR is higher than the extracted strand RRR.

# Flux Jumps at 4.3 K up to 4 kA

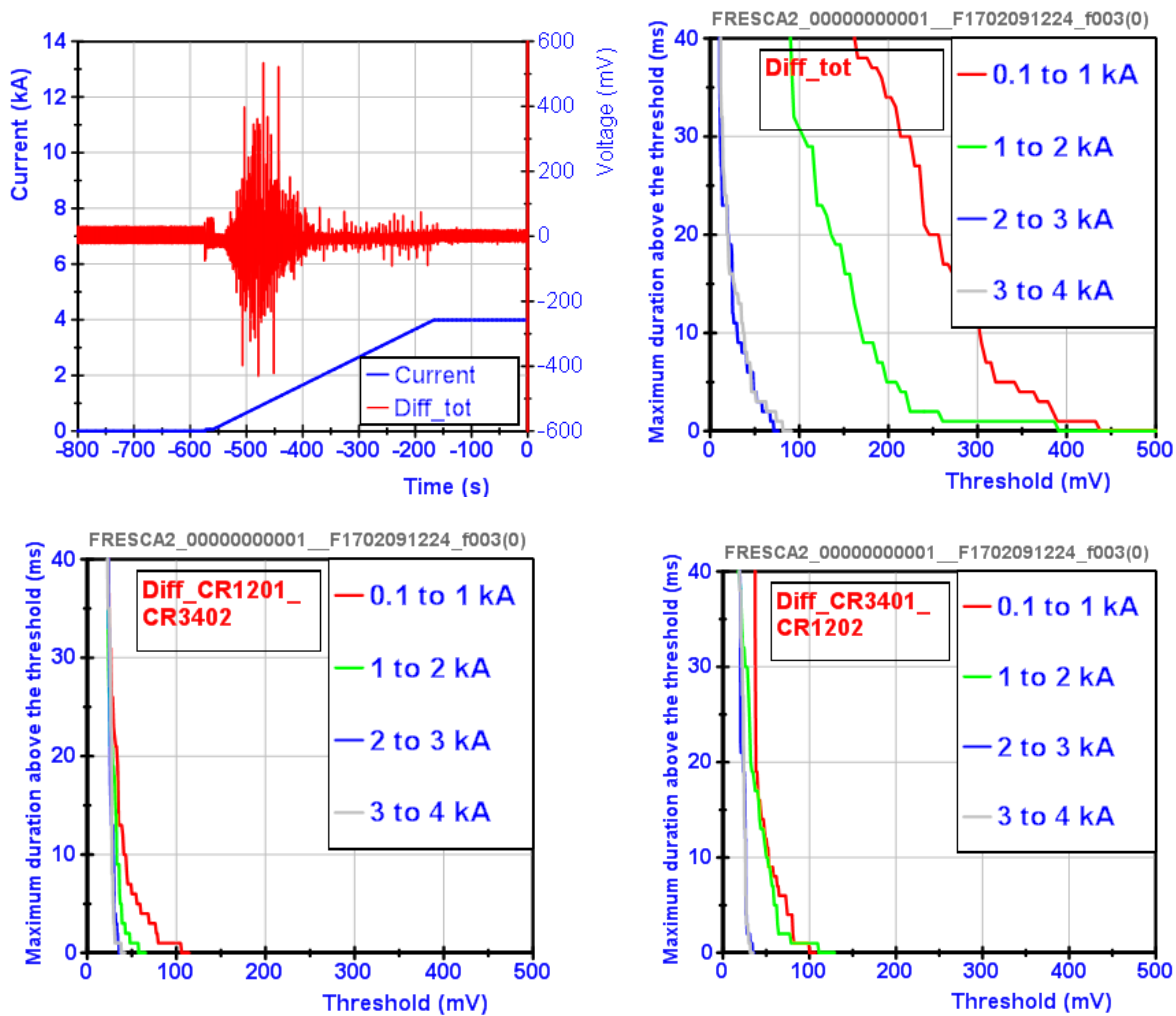

Flux jumps prevent setting the threshold

# Flux Jumps at 1.9 K up to 6 kA

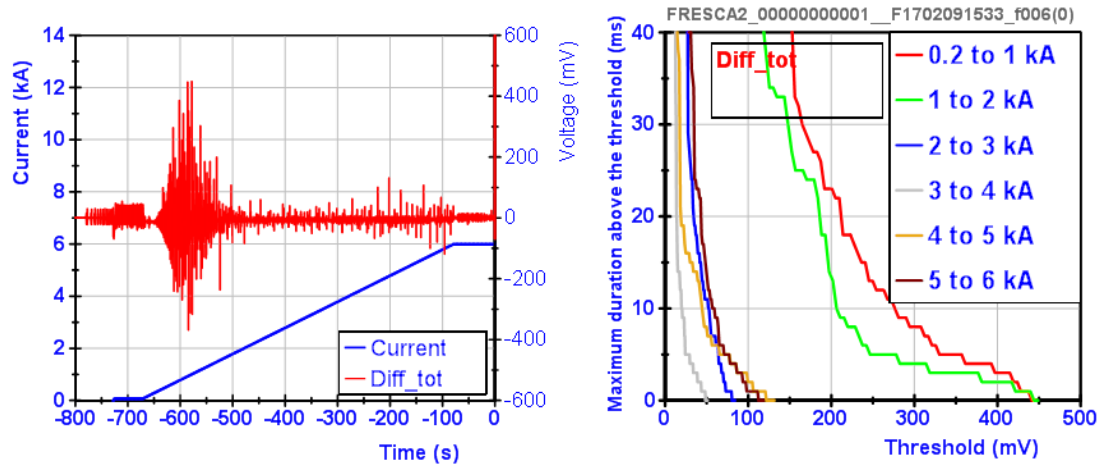

# Magnet protection

- Magnet protection is a trade off between avoiding trips and catching the quench in time. Low-current flux-jumps can trip the protection.
- Settings used:

Name	Voltage taps	Threshold (mV)	Validation time (ms)
Diff_total	1,3,5	400	15
Diff_3401-1202	1,2,3	150	10
Diff_1201-3402	3,4,5	150	10
Splices	Vtaps directly around splice	5	10

Next time: reduce threshold Diff\_total to 200 mV, increase validation time to 50 ms or use current dependent threshold

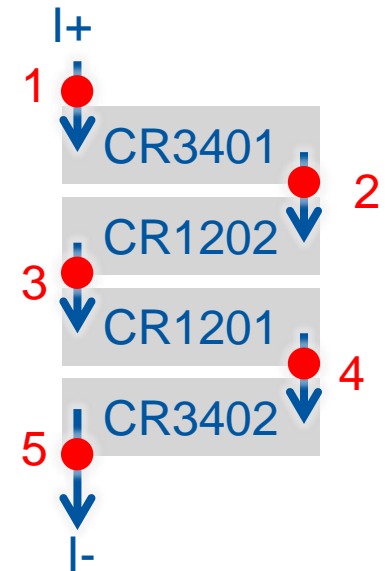

## Start of the ramp with Power Converter:

Big drop in inductance (120 mH at low current, 60 mH at high current) makes it difficult for the PC PID to give a stable current. Differential protection was de-activated up to 200 A.



# Quench heater efficiency

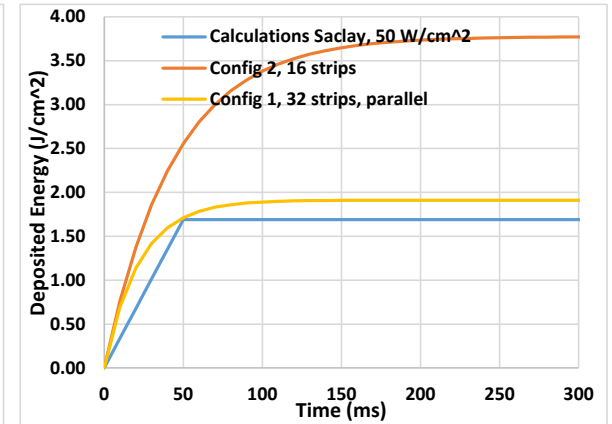
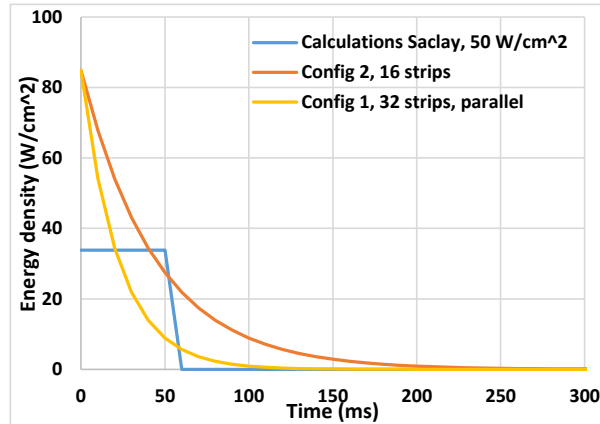
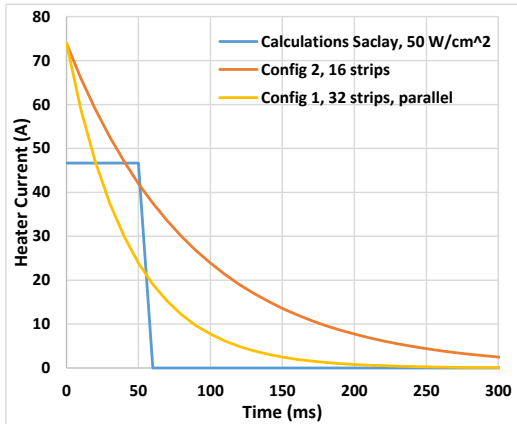

Due to limited number of 8 QH power supplies two configurations were tested at 4 kA, 4.3 K:

1. Using all 31 heater strips (same density, half the time constant, half the energy)
2. Using 16 heater strips

Configuration 2 gave already better results for low current: this was chosen for further testing.

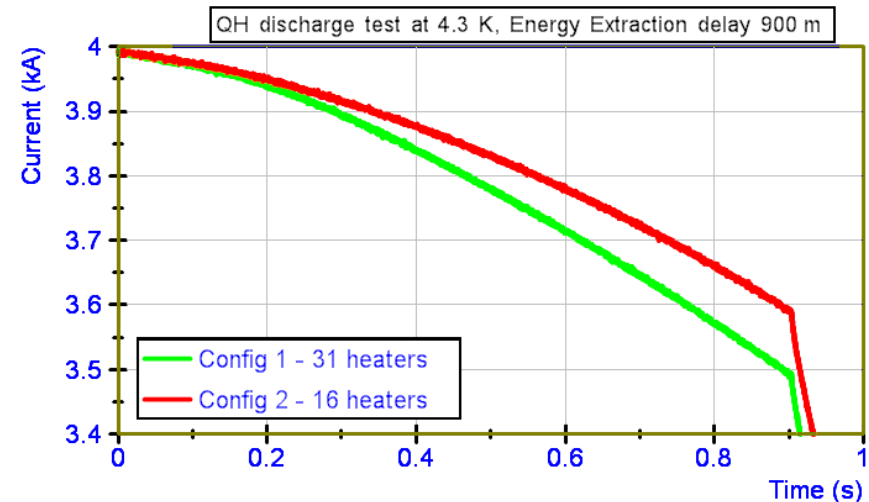

# Protection with Energy Extraction only

3 out of 32 Quench heaters failed.

Quench heaters do not show to be the most effective at 1.9 K, 9.6 kA (further studies needed).

Energy Extraction limited by 1 kV on switch:

13 T -> 10.8 kA -> limit is 92 m $\Omega$ .

15 T -> 12.8 kA -> limit is 78 m $\Omega$ .

We have fixed steps, including 60 and 80 m $\Omega$

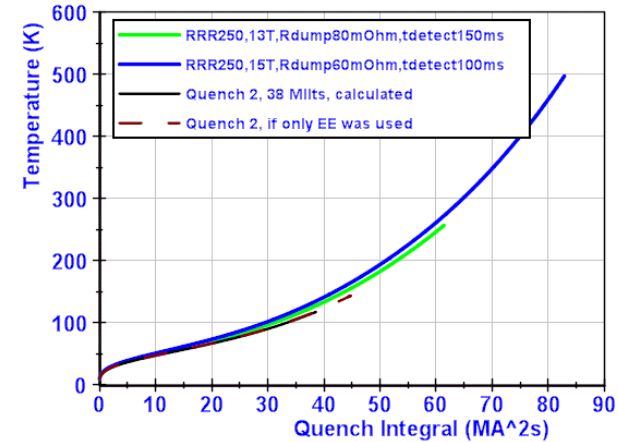
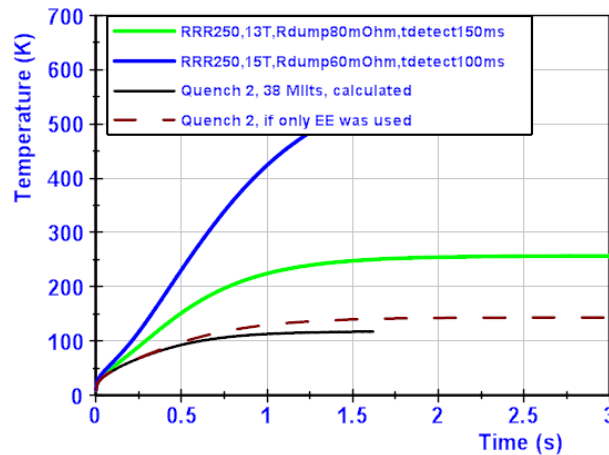
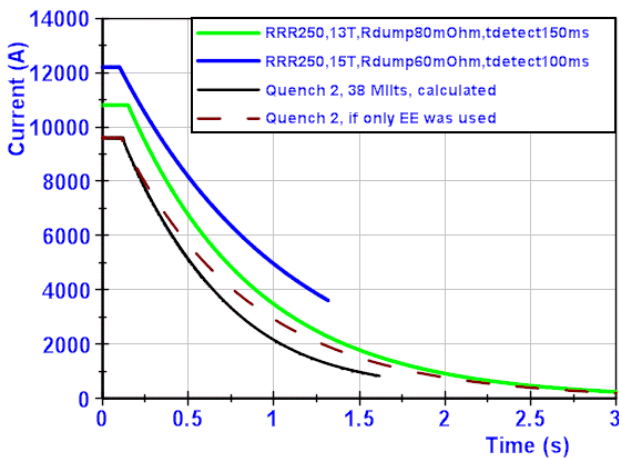

Conclusion: Operation to 13 kA could be safe without QH

Operation to 15 kA (60 m $\Omega$  dump) requires help from QH/quenchback

# Quench 2 - 6

Precursors in the 6 training quenches

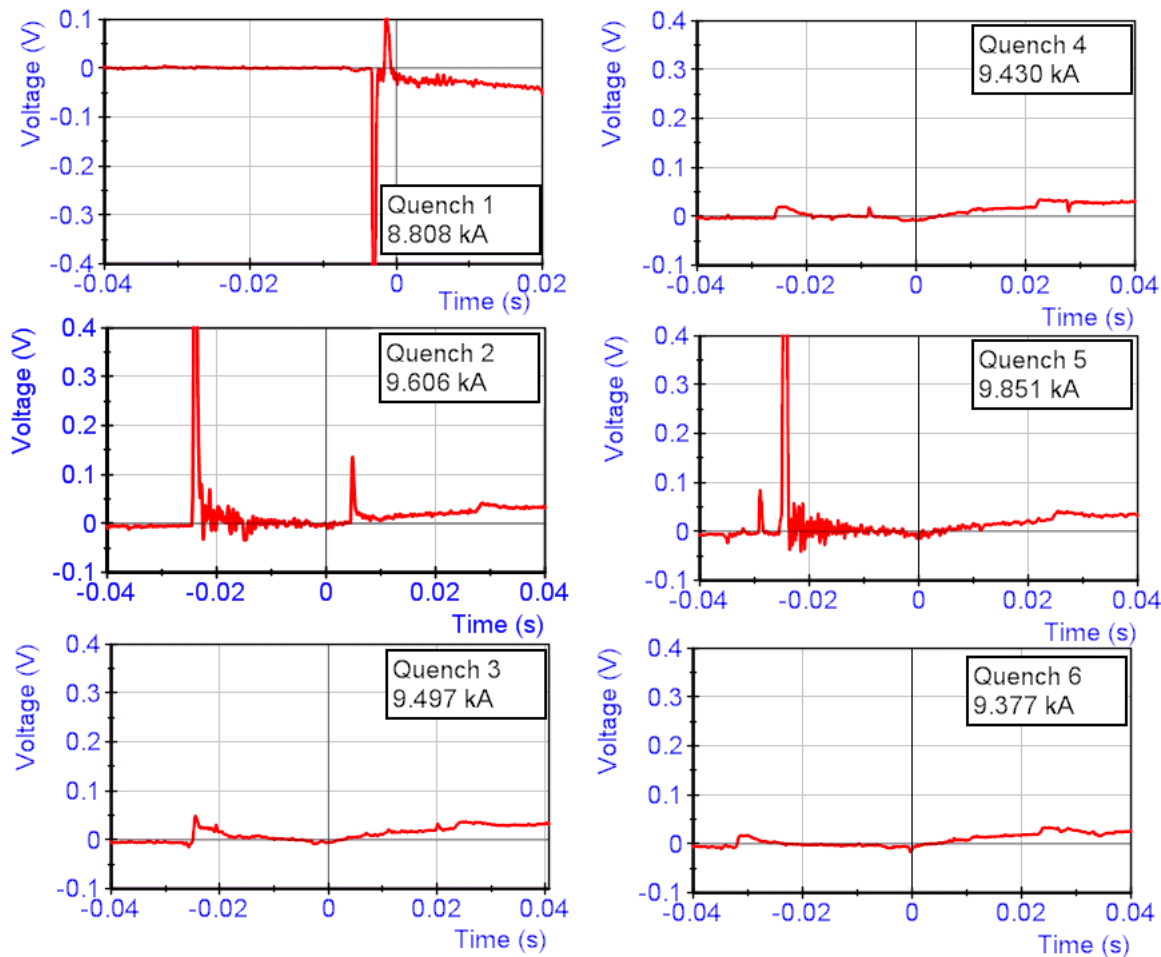

Quench 2 and 5 had the largest precursors (and highest current).  
Quench 3, 4 and 6 also had precursors.

# Failed heater circuit

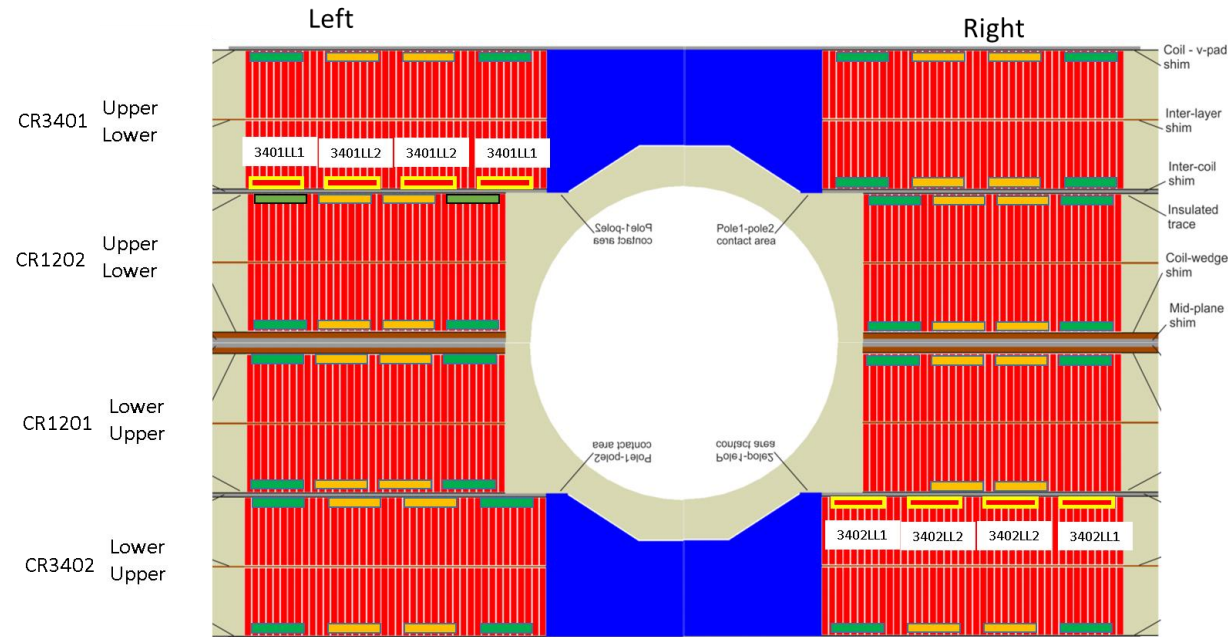

For circuit 7 :

3401LL1+3402LL1  
parallel to  
3401LL2+3402LL2



2 quench heater traces series connected inside the cryostat.

On the outside two circuits connected in parallel

# Quench heater circuit failure

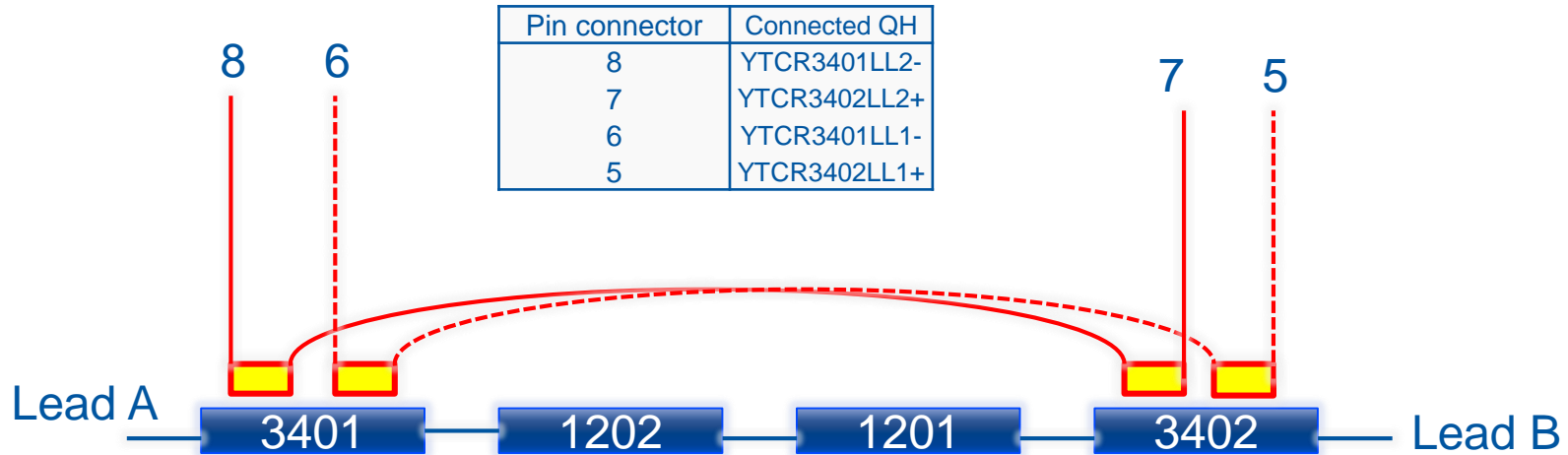

Pin - pin	Resistance measured (Ohm)
5-6	11.2
7-8	17.9
5-A	81
6-A	77.4
7-A	15.4
8-A	13.2
5-7	80.4
5-8	77.4
6-7	76.8
6-8	73.8

## Conclusions

Short to coil circuit 5-6 of 7 Ohm  
 Short to coil circuit 7-8 of 60 Ohm

Short circuit 5-6 closer to 6 than to 5  
 Short circuit 7-8 closer to 8 than to 7  
 Short likely in CR3401

High resistance of 7 and 60 Ohm are unlike loosely touching wires, more probably it is carbon contact.

Nominal strip resistance about 5.5 Ohm

# Failed heater circuit

From continuity measurement at room temperature:  
Touching at turn 22 ± 1 (counting from splice)



From Transfer Function measurements at 4 K by Mateusz Bednarek, QH is touching the coil at about 70 % of in coil inductance, seen from upper splice.

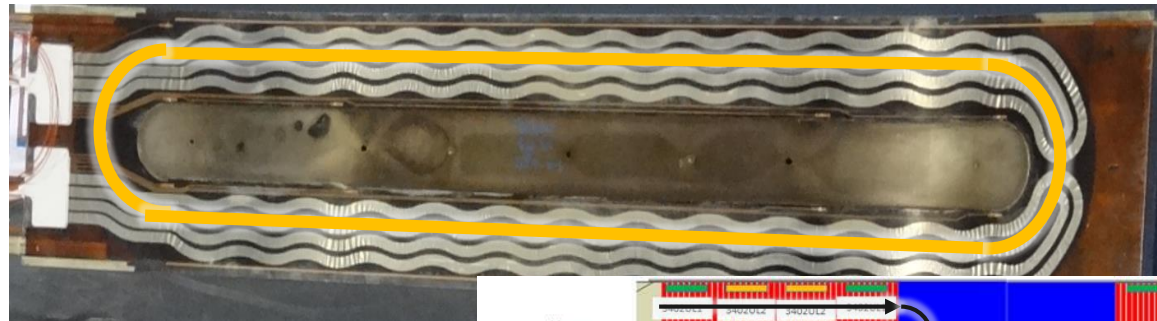

CR3401 Upper Lower



From 4 point measurements of the QH at 4 K, QH 3401LL1 is touching QH 3401LL2 at about 70 % of the strip length see from 3401LL1- or 3401LL2-



# Failed heater circuit

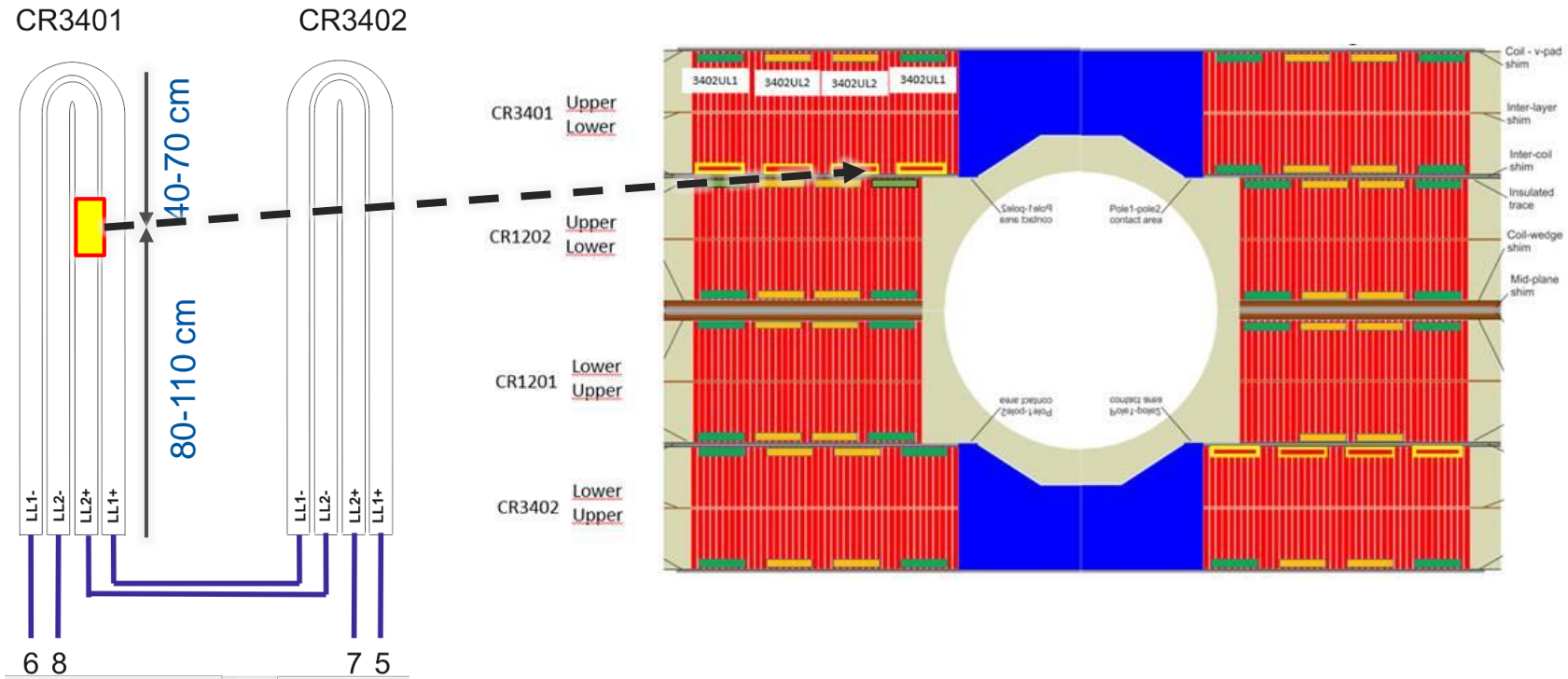

# Quench heater circuit failure

## Procedure in case of quench heater failure

- Disconnect faulty quench heaters
- HV test coil-ground is OK.
- Further analysis with transfer function and reflectometry ongoing.
- The location seems quite well understood and there seems to be clearly insulation damage.

## Unknown:

- With damage reaching to the neighboring heater strip, could there also be damage towards coil 1202?
- If insulation is damaged, how large or likely are interturn shorts?

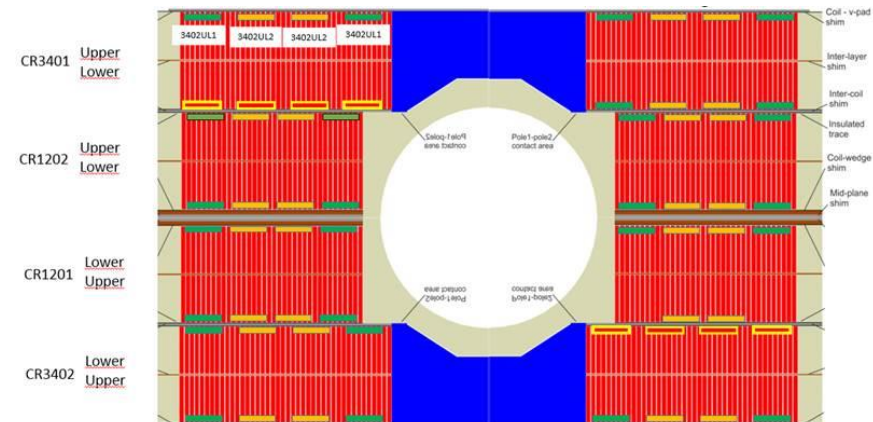
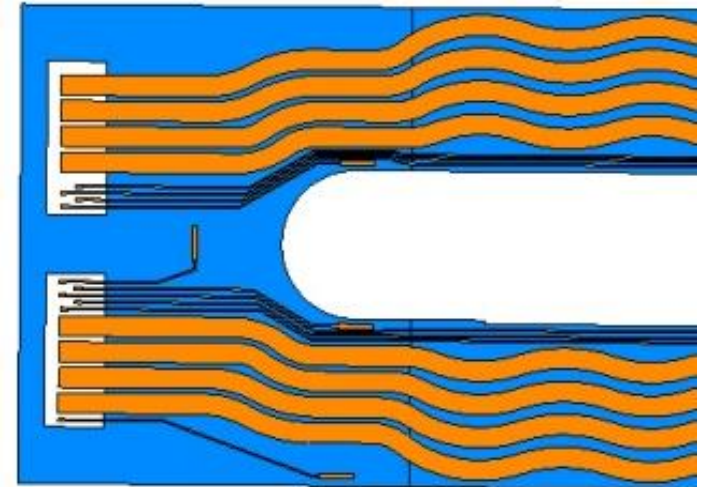



# Baseline Ansys models

- 2D model:
  - 0.2 friction everywhere, bonded inside the coils
  - Coil modulus: orthotropic, 45/52 GPa (x/y, 4.2-293 K)
  - Coil contraction: orthotropic, 3.36/3.08 mm/m (x/y, 293 to 4.2 K)
- 3D model:
  - 0.2 friction everywhere, bonded inside the coils
  - Coil modulus: isotropic, 45 GPa (4.2-293 K)
  - Coil contraction: isotropic, 3.36 mm/m (293 to 4.2 K)

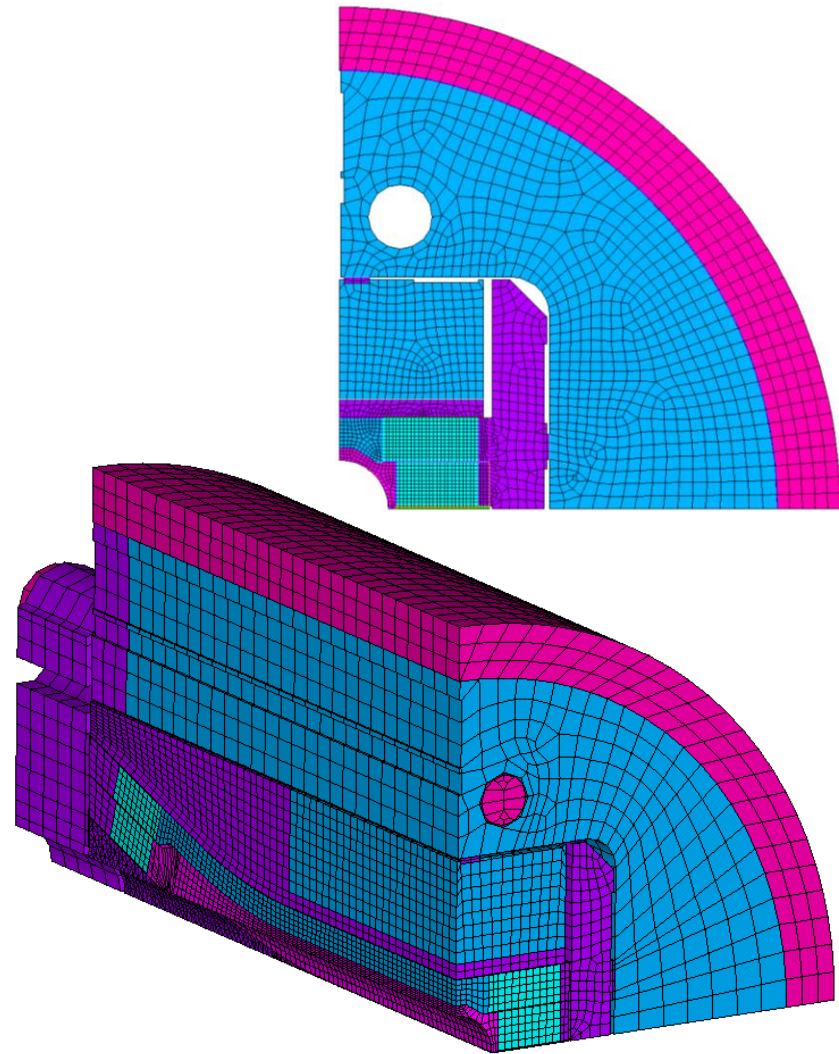

# Strain on the shell

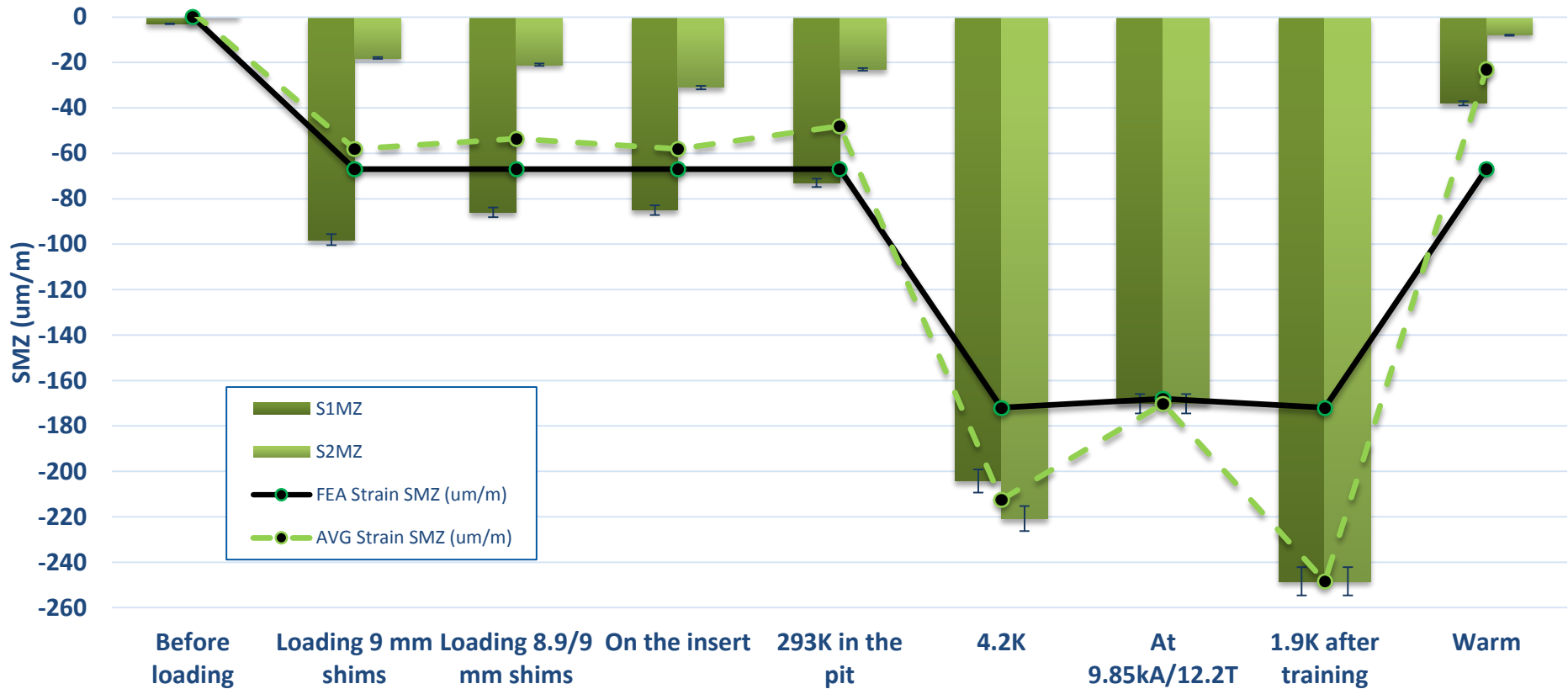

- Difference of 40  $\mu\text{str}$  during cool-down
- Loss of 25  $\mu\text{str}$  after warm-up

[P. Grosclaude, TE-MME-EDM]

# Strain on the poles

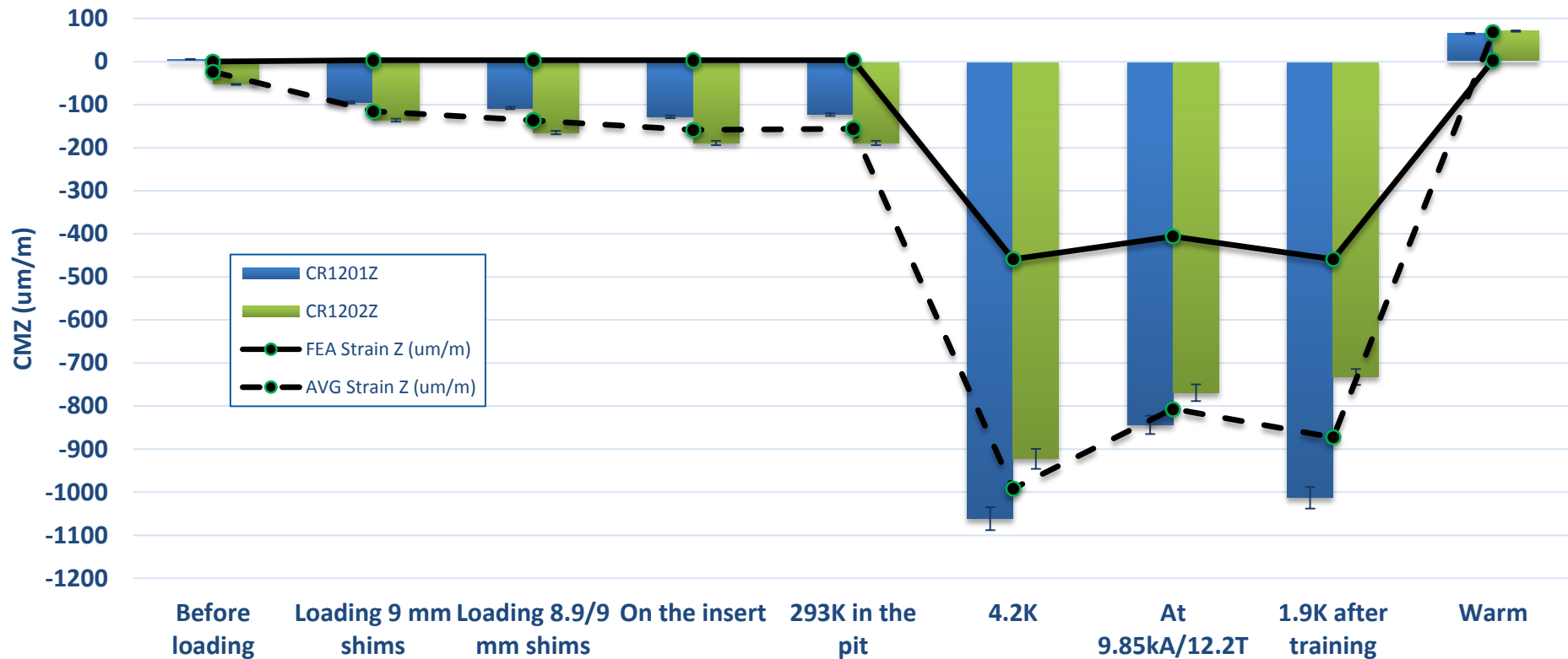

[P. Grosclaude, TE-MME-EDM]

# Strain on the shell ( $\epsilon$ Vs. $\theta$ )

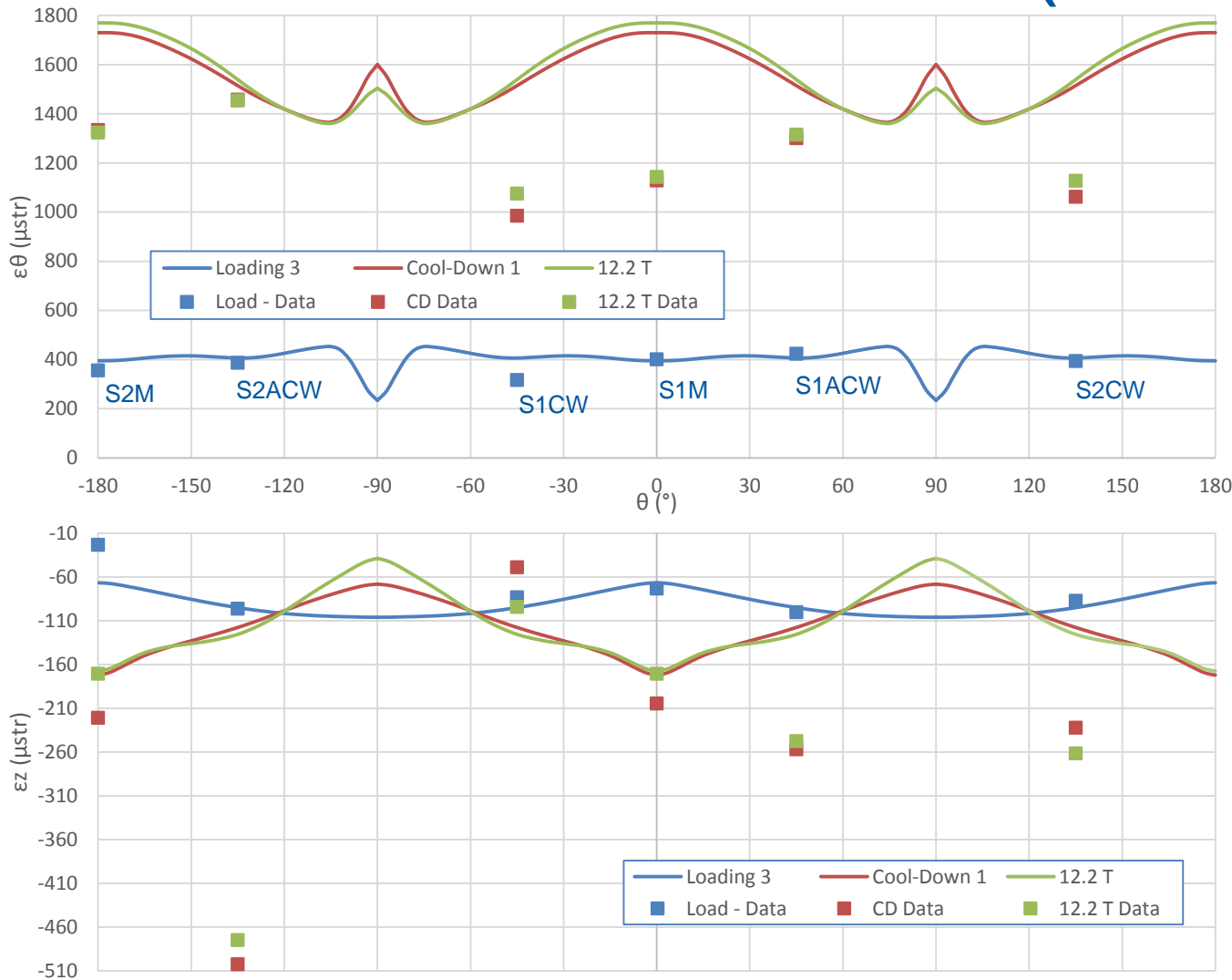

- Good agreement during loading
- After cool-down: un-balanced top/bottom (CW/ACW), same effect left/right (1/2)

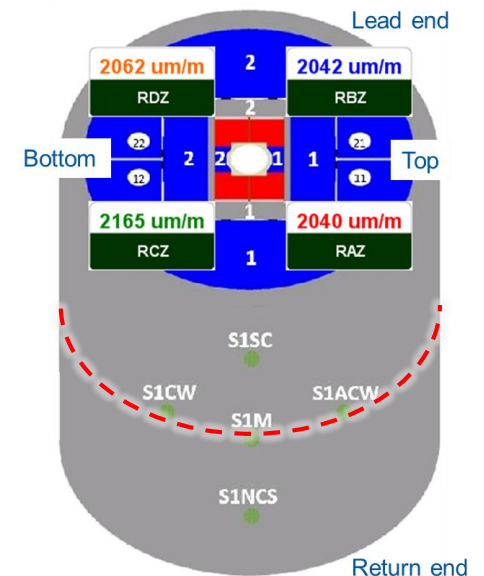

# Strain on the shell ( $\epsilon$ Vs. $z$ )

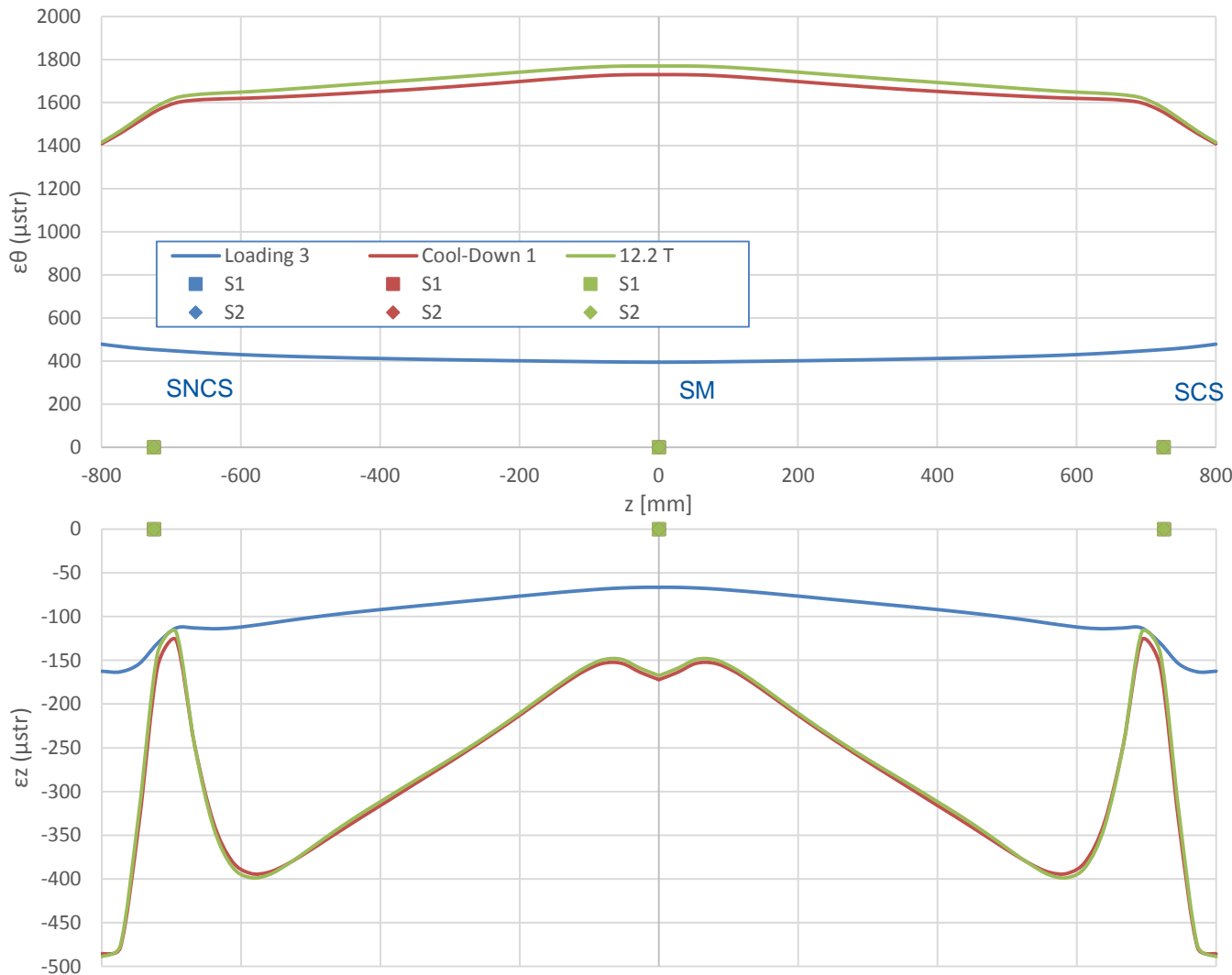

- Good agreement during loading
- After cool-down: un-balanced Return End/Lead End

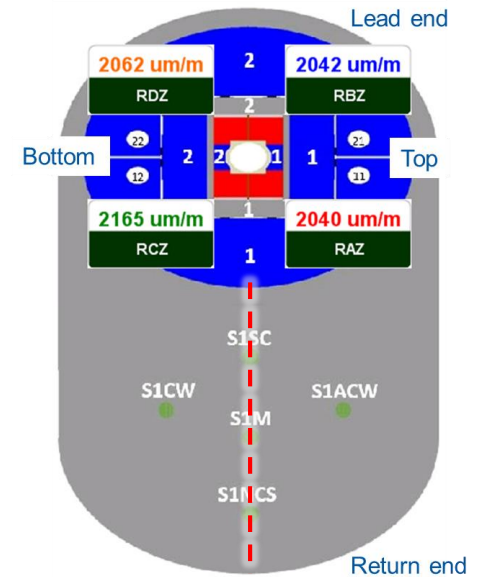

Many thanks to everybody!



29/03/2017

E. Rochepault

78