

A Facility for Hidden Sector exploration at SPS CERN

Seminar IRFU/SPP, Mar. 2, 2015



Andrey Golutvin
Imperial College London



Maxim Titov
CEA Saclay, IRFU/SPP

SHiP

Search for Hidden Particles



SHiP Collaboration as on 9th February 2015

(List of Institutes signing SHiP Technical Proposal)

¹ Sofia University, Sofia, Bulgaria

² Universidad Técnica Federico Santa María, Valparaíso, Chile

³ Niels Bohr Institute, Copenhagen University, Copenhagen, Denmark

⁴ LAL, Université Paris-Sud, CNRS/IN2P3, Orsay, France

⁵ LPNHE, Université Pierre et Marie Curie, Université Paris Diderot, CNRS/IN2P3, Paris, France

⁶ Humboldt-Universität zu Berlin, Berlin, Germany

⁷ Universität Hamburg, Hamburg, Germany

⁸ Sezione INFN di Bari, Bari, Italy

⁹ Sezione INFN di Bologna, Bologna, Italy

¹⁰ Sezione INFN di Cagliari, Cagliari, Italy

¹¹ Sezione INFN di Ferrara, Ferrara, Italy

¹² Sezione INFN di Napoli, Napoli, Italy

¹³ Laboratori Nazionali dell'INFN di Gran Sasso, Frascati, Italy

¹⁴ Laboratori Nazionali dell'INFN di Frascati, Frascati, Italy

¹⁵ Sezione INFN di Roma La Sapienza, Roma, Italy

¹⁶ Aichi University of Education, Kariya, Aichi, Japan

¹⁷ Kobe University, Kobe, Hyogo, Japan

¹⁸ Nagoya University, Chikusa-ku, Nagoya, Japan

¹⁹ Nihon University, Chiyoda, Tokyo, Japan

²⁰ Toho University, Ota, Tokyo, Japan

²¹ Joint Institute of Nuclear Research (JINR), Dubna, Russia

²² Institute of Theoretical and Experimental Physics (ITEP), Moscow, Russia

²³ Institute for Nuclear Research (INR), Moscow, Russia

²⁴ P.N. Lebedev Physical Institute (LPI), Moscow, Russia

²⁵ National Research Centre Kurchatov Institute (NRC), Moscow, Russia

²⁶ Institute for High Energy Physics (IHEP), Protvino, Russia

²⁷ Petersburg Nuclear Physics Institute (PNPI), Gatchina, Russia

²⁸ Moscow Engineering Physics Institute (MEPhI), Moscow, Russia

²⁹ Skobeltsyn Institute of Nuclear Physics of Moscow State University (SINP MSU), Moscow, Russia

³⁰ Yandex School of Data Analysis, Moscow, Russia

³¹ Stockholm University, Stockholm, Sweden

³² Uppsala University, Uppsala, Sweden

³³ European Organization for Nuclear Research (CERN), Geneva, Switzerland

³⁴ University of Geneva, Geneva, Switzerland

³⁵ Ecole Polytechnique Fédérale de Lausanne (EPFL), Lausanne, Switzerland

³⁶ Physik-Institut, Universität Zürich, Zürich, Switzerland

³⁷ Middle East Technical University (METU), Ankara, Turkey

³⁸ Ankara University, Ankara, Turkey

³⁹ H.H. Wills Physics Laboratory, University of Bristol, Bristol, United Kingdom

⁴⁰ Department of Physics, University of Warwick, Coventry, United Kingdom

⁴¹ STFC Rutherford Appleton Laboratory, Didcot, United Kingdom

⁴² Imperial College London, London, United Kingdom

⁴³ University College London, London, United Kingdom

⁴⁴ Florida University, Florida, FL, United States

^a Università di Bari, Bari, Italy

^b Università di Bologna, Bologna, Italy

^c Università di Cagliari, Cagliari, Italy

^d Università di Ferrara, Ferrara, Italy

^e Università di Roma La Sapienza, Roma, Italy

**Includes a contribution from
2 French groups signing the TP,**

**and acknowledgement to a personal
contribution from Maxim Titov**

Some history and current status

- ✓ Oct 2013: submitted our EOI: CERN-SPSC-2013-024 ; arXiv:1310.1762 ; SPSC-EOI-010
- ✓ January 2014: EOI discussed at SPSC
 - Encouraged to produce “an extended proposal with further developed physics goals, a more detailed technical design and a stronger collaboration.”*
- ✓ *Work towards Technical Proposal in full swing*
 - Extension of physics program*
 - Signal background studies and optimization*
 - Detector specification, simulation and even some detector R&D*
 - Optimization of Experimental Facility - beam line, target, and muon filter, RP, overall layout*
- ✓ *1st SHiP Workshop in Zurich in June with a 100 experimentalists and theorists*
 - 41 institutes from 14 countries expressed interest to contribute to the Technical Proposal*
- ✓ *2nd SHiP Workshop/Collaboration meeting at CERN September 24-26*
 - Revise progress in Working Groups towards Technical Proposal*
 - Extend physics for a general purpose facility: Tau neutrino, LFV and direct Dark Matter search*
- ✓ *3rd SHiP Collaboration meeting at CERN December 15*
 - Revise progress towards TP and Physics Proposal (PP). Formalize Collaboration as proposed by CERN management with 44 institutes (14 countries)*
- ✓ *4th SHiP Collaboration meeting in Naples, February 9-11*
 - Finalize contents for TP and PP*
- ✓ **First drafts of TP and PP distributed for comments, end of February**

Next steps: schedule of the SHiP facility

EUROPEAN ORGANIZATION FOR NUCLEAR RESEARCH (CERN)



CERN-SPSC-2015-XXX
23:59:59, 23 February 2015, v0.1

Technical Proposal

A Facility to Search for Hidden Particles (SHiP) at the SPS

The SHiP Collaboration¹

Abstract

A new general purpose fixed target facility is proposed at the CERN SPS accelerator which is aimed at exploring the domain of hidden particles and make measurements with tau neutrinos. Hidden particles are predicted by a large number of recently elaborated models of Hidden Sectors. The high intensity of the SPS 400 GeV/c beam allows probing a wide variety of models with light long-lived exotic particles with masses below $O(10)$ GeV/c², including feebly interacting low-energy phenomena of SUSY. Moreover, the experimental programme of the facility may be extended in the future to include direct searches for Dark Matter and Lepton Flavour Violation.

The facility is serviced by a new dedicated beam line which is branching off the splitter section in the North Area, followed by a new target station and a magnetic shield to suppress beam induced background. In the initial phase, the facility will host a detector to search for hidden particles in combination with a compact tau neutrino detector. The hidden particle detector consists of a long evacuated decay volume ending with a magnetic spectrometer, calorimeters and muon detectors to allow full reconstruction and particle identification of hidden particle decays. The neutrino detector consists of an emulsion target equipped with tracking in a magnetic field followed by a muon spectrometer.

The current SPS is capable of providing an integrated total of $2 \cdot 10^{20}$ protons on target in five years of operation in nominal conditions. This allows accessing a significant fraction of the unexplored parameter space for Hidden Sectors with sensitivities which are several orders of magnitude better than previous experiments. The associated neutrino detector allows performing a number of unique measurements with tau neutrinos, including a first experimental verification of the existence of the anti-tau neutrino.

The SHiP facility is providing a unique experimental platform for physics at the Intensity Frontier which is complementary to the searches for New Physics at the Energy Frontier.

¹Authors are listed on the following pages.

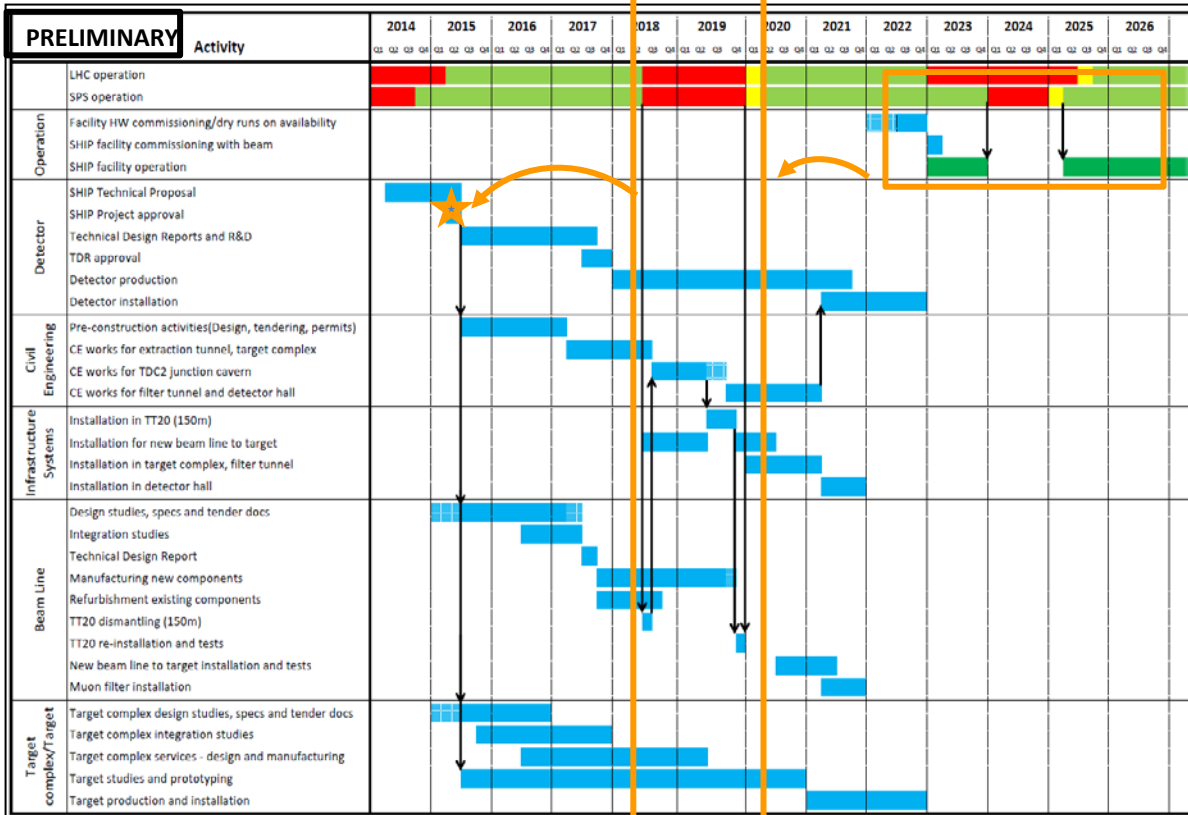

A few milestones:

- ✓ **Technical proposal** → **March 2015**
- ✓ **CERN to decide on the strategy for the SHiP beam within a year after TP submission**
- ✓ **Technical Design Report** → **2018**
- ✓ **Construction and installation** → **2018 – 2022**
- ✓ **Data taking and analysis of 2×10^{20} pot** → **2023 – 2027++**

Introduction

- ✓ SHiP is a general purpose fixed target facility to explore the domain of hidden particles (HP) with masses below $O(10)$ GeV. HP are predicted in many models explaining known shortcomings of the SM as described in Physics Proposal
- ✓ SHiP will use high intensity spills at 400 GeV similar to CNGS programme
Full exploitation of the protons available at SPS after the demands of LHC and other fixed target experiments !
- ✓ SPS beam is ideal in terms of its intensity and energy in maximizing the sensitivity reach for HP in charm decays
- ✓ Also ideal for ν_τ physics ($D_S \rightarrow \tau \nu_\tau$)
- ✓ Brief comparison with fixed target experiment at FNAL and KEK beams, and with colliding experiment at LHC running at $\sqrt{s} = 14$ TeV assuming a luminosity of 1000 fb^{-1}
- ✓ The scope of the proposed facility is wider than the physics objectives of SHiP, e.g. searches for LFV $\tau \rightarrow 3\mu$, direct search for DM require dedicated experiments

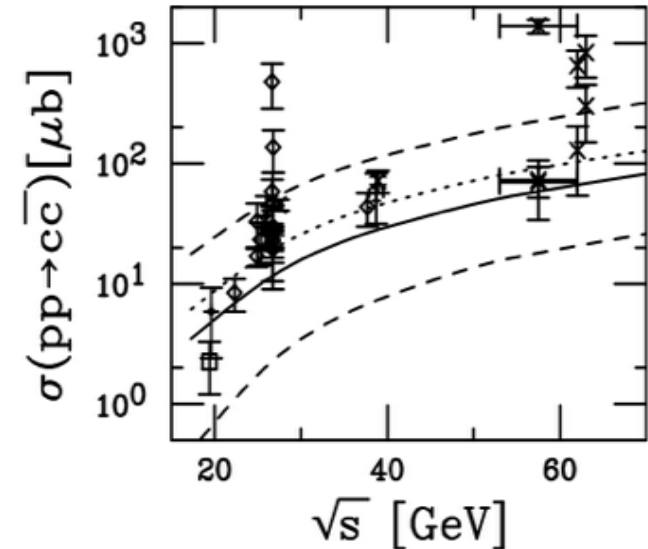

Introduction

- ✓ *SHiP is complementary to the other running or planned projects searching for NP*
 - *direct searches by ATLAS and CMS at $\sqrt{s}=14$ TeV (perhaps at FCC in pp-mode later)*
 - *indirect searches in flavour physics: LHCb, BELLE 2, NA62 (in kaon sector)*
 - *also muon anomalous magnetic moment, LFV searches, proton decay etc...*
- ✓ ***Anticipate a recommendation by the SPSC committee and a decision by CERN on the strategy for SHiP within a year of the submission of TP***
- ✓ *The remaining choices of baseline technologies will be made in time to submit Technical Design Reports by 2018*
- ✓ ***The detector construction, five years of data taking, and the data analysis of 2×10^{20} p.o.t. can be achieved in ~10 years***

Physics Motivation

SM is great but it is not a complete theory

Experimental facts of BSM physics

- *Neutrino masses & oscillations*
- *The nature of non-baryonic Dark Matter*
- *Excess of matter over antimatter in the Universe*
- *Cosmic inflation of the Universe*

Theoretical shortcomings

Gap between Fermi and Planck scales, Dark Energy, connection to gravity, resolution of the strong CP problem, the naturalness of the Higgs mass, the pattern of masses and mixings in the quark and lepton sectors, ...

No clear guidance on the scale of NP and on its coupling strength to the SM particles !

An example: See-saw generation of neutrino masses

Most general renormalisable Lagrangian of all SM particles (+3 singlets wrt the SM gauge group):

$$L_{\text{singlet}} = i\bar{N}_I \partial_\mu \gamma^\mu N_I - Y_{I\alpha} \bar{N}_I^c \tilde{H} L_\alpha^c - M_I \bar{N}_I^c N_I + \text{h.c.},$$

Yukawa term: mixing of N_I with active neutrinos to explain oscillations

Majorana term which carries no gauge charge

The scale of the active neutrino mass is given by the see-saw formula: $m_\nu \sim \frac{m_D^2}{M}$ where $m_D \sim Y_{I\alpha} v$ - typical value of the Dirac mass term

Example:

For $M \sim 1 \text{ GeV}$ and $m_\nu \sim 0.05 \text{ eV}$ it results in $m_D \sim 10 \text{ keV}$ and Yukawa coupling $\sim 10^{-7}$

Smallness of the neutrino mass hints either on very large M or very small $Y_{I\alpha}$

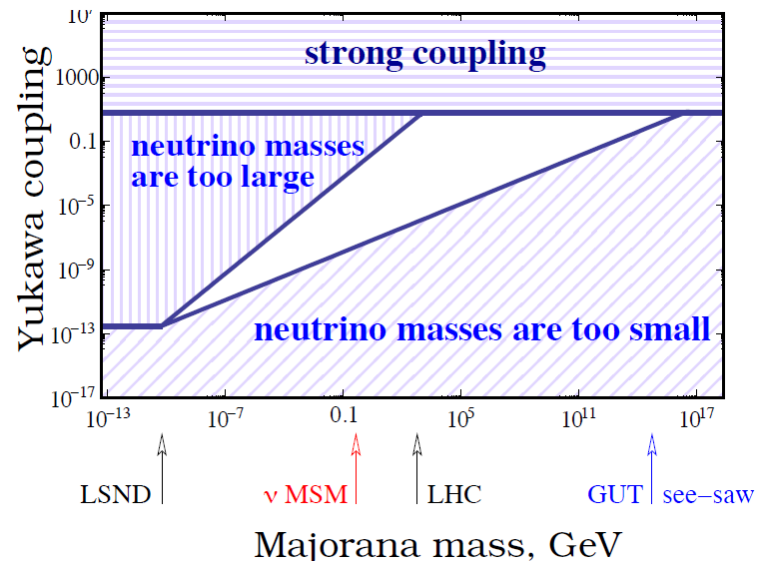

BSM theories with a new energy scale *(which may also have light particles)*

SUSY is an example

- ✓ *From naturalness expect SUSY masses comparable to the Higgs mass to avoid significant fine tuning*
- ✓ ***Could still have light NP. SUSY breaking may be accompanied by s-goldstinos (P,S) with couplings $\sim 1 / (\text{SUSY breaking scale})$
→ may have evaded detection***

e.g. $D \rightarrow \pi X$, then $X \rightarrow l^+ l^-$; [Gorbunov, 2001, LHCb: Aaij et al., 2013]
 $B_s^0 \rightarrow P S$, then $P, S \rightarrow \mu^+ \mu^-$

- ✓ *R-parity violating neutralinos in some SUSY models*

e.g., [Dedes et al., 2001]

e.g. $D \rightarrow l \tilde{\chi}$, then $\tilde{\chi} \rightarrow l^+ l^- \nu$

Models with Dark sector: impressive list of ideas in the past

(pioneered by Bjorken and Okun)

Holdom, Galison, Manohar, Arkani-Hamed, Weiner, Schuster, Essig, Pospelov, Toro, Batell, Ritz, Andreas, Goodsell, Abel, Khoze, Ringwald, Fayet, Cheung, Ruderman, Wang, Yavin, Morrissey, Poland, Zurek, Reece, Wang, ...

- ✓ *Hidden particles are singlets with respect to the SM gauge group*
- ✓ *Very weak interactions with the SM particles through portals described by various operators with vector, Higgs, neutrino and axion forms*
- ✓ *Isolated Dark sector naturally provides DM candidates*
- ✓ ***Dark Sector may have a rich structure of light hidden messengers between Dark sector and SM particles***
- ✓ ***No theoretical input on the Dark Sector mass scale → may well happen to be accessible at future experiments***

Mirror matter: to restore P , C and CP

Vector portal

Okun, Voloshin, Ellis, Schwarz, Tyupkin, Kolb, Seckel, Turner, Georgi, Ginsparg, Glashow, Foot, Volkas, Blinnikov, Khlopov, Gninenko, Ignatiev, Berezhiani,...

Dim 2: Hypercharge $U(1)$ field, $B_{\mu\nu}$

New particle – massive vector photon (paraphoton, secluded photon, ...)

renormalisable coupling – kinetic mixing $\rightarrow \varepsilon B_{\mu\nu} F'^{\mu\nu}$

Production: through a virtual photon: electron or proton fixed-target experiments, e^+e^- and hadron colliders, $\sigma \propto \varepsilon^2$. Decay due to the mixing with photon to the pair of charged particles:

e^+e^- , $\mu^+\mu^-$, $\pi^+\pi^-$, etc, etc or to invisible particles from the dark sector.

Constraints are coming from:

- SLAC and Fermilab beam dump experiments E137, E141, E774
- electron and muon anomalous magnetic moments
- KLOE, BaBar
- PS191, NOMAD, CHARM (CERN)

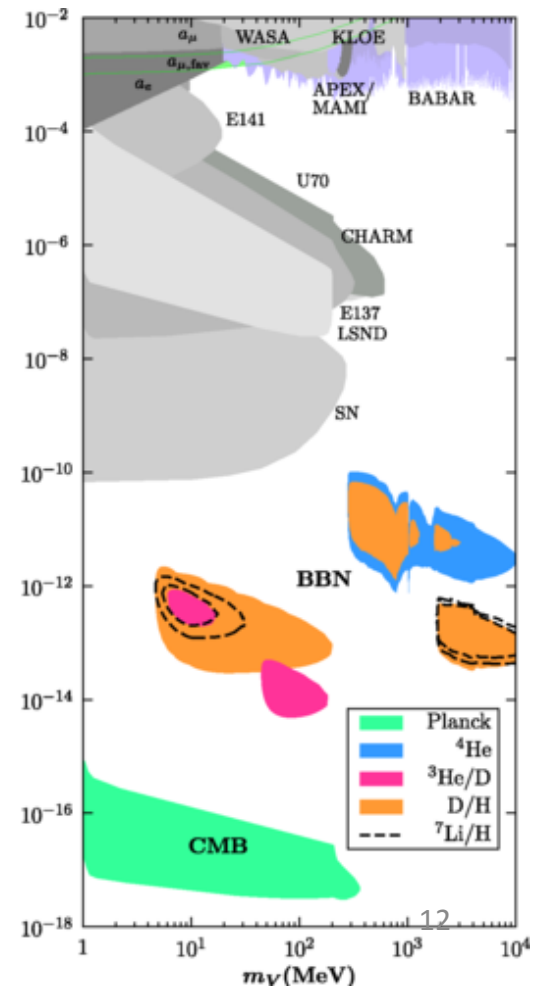

Higgs portal

Patt, Wilczek, Schabinger, Wells, No, Ramsey-Musolf, Walker, Khoze, Ro, Choi, Englert, Zerwas, Lebedev, Mambrini, Lee, Jaeckel, Everett, Djouadi, Falkowski, Schwetz, Zupan, Tytgat, Pospelov, Batell, Ritz, Bezrukov, Gorbunov, Gunion, Haber, Kane, Dawson, ...

Dim 2: Higgs field $H^\dagger H$

New particle – hidden (dark) scalar with renormalisable coupling

$$(\mu\chi + \lambda\chi^2)H^\dagger H$$

$$\begin{pmatrix} H \\ h \end{pmatrix} = \begin{pmatrix} \cos \rho & -\sin \rho \\ \sin \rho & \cos \rho \end{pmatrix} \begin{pmatrix} \phi'_0 \\ S' \end{pmatrix}$$

- ✓ Convenient parameterization of an extended Higgs sector: two Higgs doublets, SUSY (e.g. light s-goldstino, scalar singlets, Higgs triplets, ...)
- ✓ Extra scalars may help in solving hierarchy problem, flavour problem, baryogenesis, Dark Matter, neutrino masses, inflaton, etc
- ✓ Production

- direct: $p + \text{target} \rightarrow \chi X$
- in flavour decays: $B \rightarrow \chi K^*$
- $\tau H \sin^2 \rho$

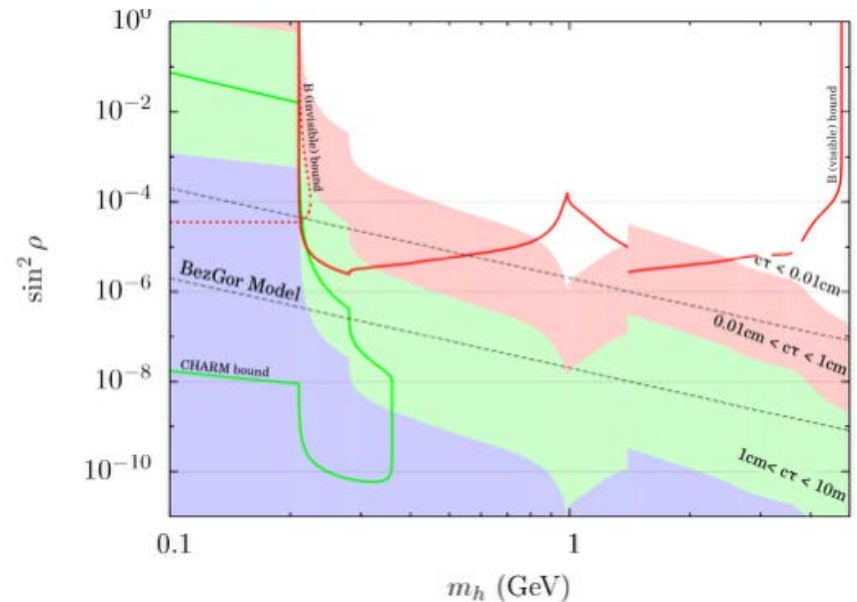
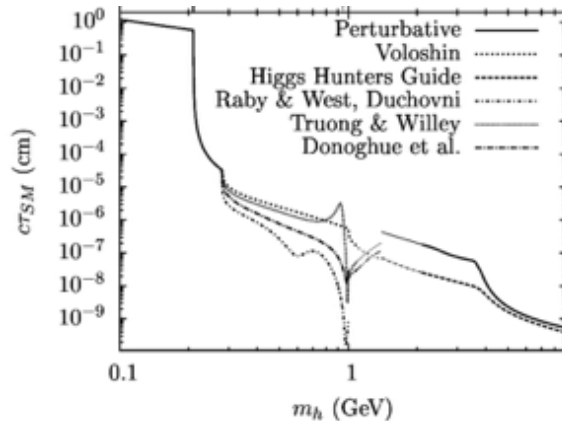

Neutrino portal

Minkowski, Yanagida, Gell-Mann, Ramond, Slansky, Glashow, Mohapatra, G. Senjanovic + too many names to write, the whole domain of neutrino physics

Dim 5/2 Higgs-lepton $H^T L$
renormalisable coupling $\rightarrow Y H^T \bar{N} L$

To set the scene (summary of the past results) :

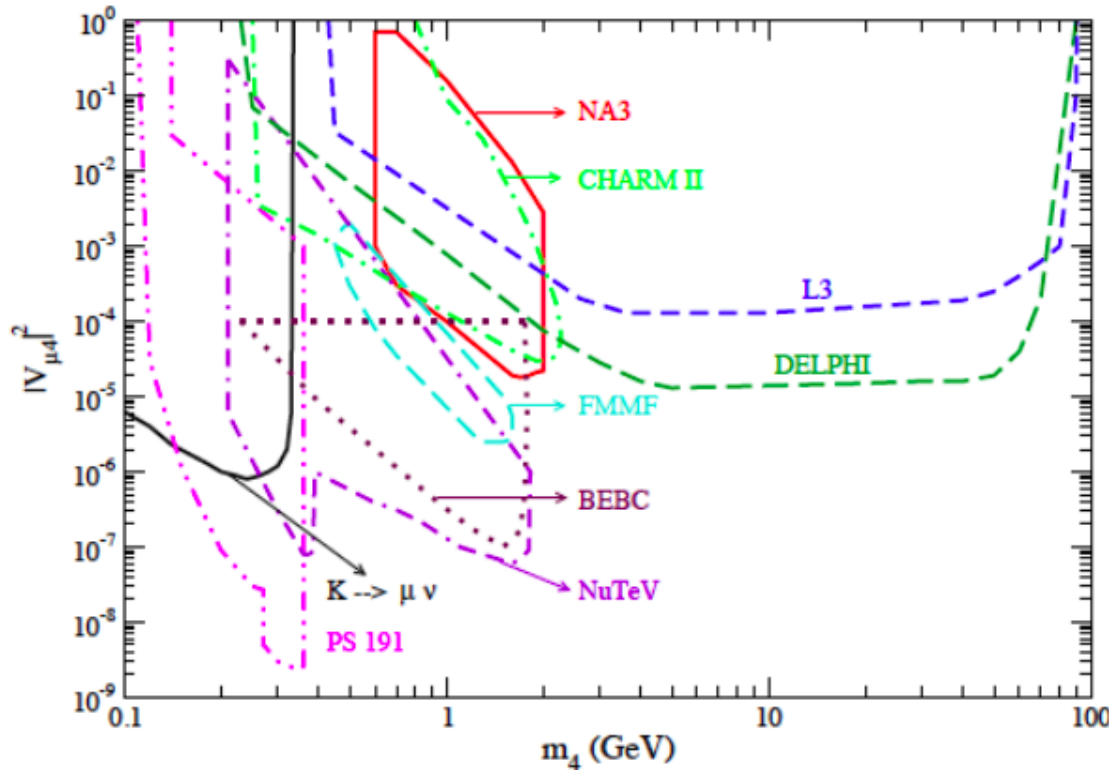

- ✓ Coupling strength to active neutrinos is U^2 , where $U^2 = U_\theta^2 + U_\mu^2 + U_\tau^2$ ($V_{\mu 4}^2 = U_\mu^2$, etc...)
- ✓ Stringent constraints on the light M_N below kaon mass
- ✓ The mass range above charm is relatively poor explored

from Atre et. al. (0901.3589)

Axion portal

Weinberg, Wilczek, Witten, Conlon, Arvanitaki, Dimopoulos, Dubovsky, Kaloper, March-Russell, Cicoli, Goodsell, Ringwald, Lazarides, Shafi, Choi, Essig, Harnik, Kaplan, Toro, Gorbunov,...

Dim 4: Axion-like Particles, pseudoscalars

Non-renormalisable couplings $\rightarrow \frac{a}{F} G_{\mu\nu} \tilde{G}^{\mu\nu}, \quad \frac{\partial_\mu a}{F} \bar{\psi} \gamma_\mu \gamma_5 \psi$

- ✓ Axions \rightarrow to solve strong CP-problem, string theory, extra dimensions
- ✓ Axion-Like Particles (or pseudo-Nambu-Goldstone bosons) \rightarrow dark matter, SUSY ...

Similar to the Higgs portal, from arXiv:1008.0636, Essig et al

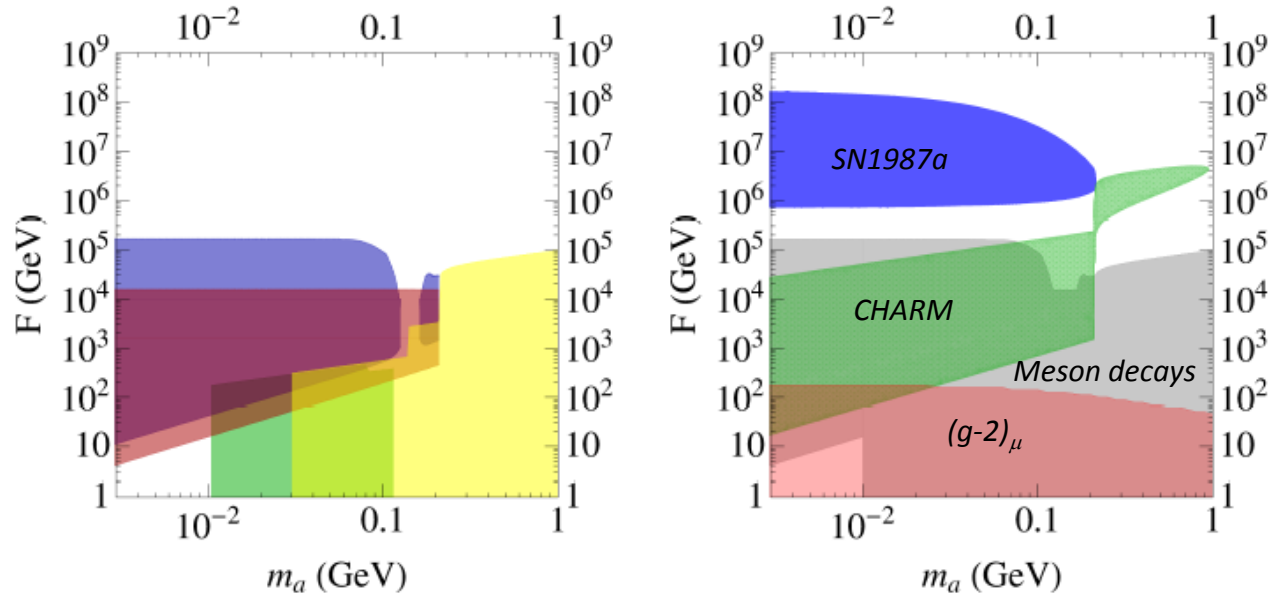

Left: $K^+ \rightarrow \text{anything} + e^+e^-$ (green); $K^+ \rightarrow \pi^+ + \text{invisible}$ (blue);
 $B^+ \rightarrow K^+ l^+ l^-$ (yellow) ($l = e, \mu$); $B^+ \rightarrow K^+ + \text{invisible}$ (red).

Right: Gray: the combined exclusion region from meson decays; green: CHARM;
blue: supernova SN 1987a; red: muon anomalous magnetic moment.

BSM theories with no NP between Fermi and Planck scales (minimalistic approach)

ν MSM (T.Asaka, M.Shaposhnikov PL B620 (2005) 17) explains all experimental shortcomings of the SM at once by adding 3 HNL: N_1, N_2 and N_3

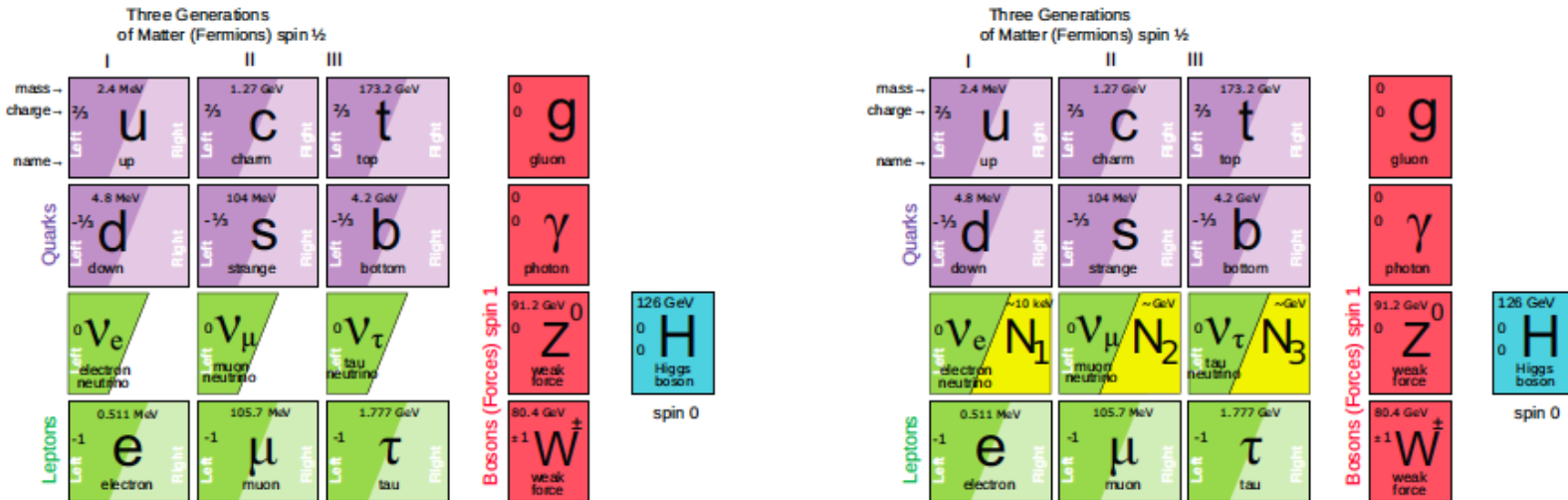

N = Heavy Neutral Lepton - HNL

Role of N_1 with mass in keV region: dark matter

Role of N_2, N_3 with mass in 100 MeV – GeV region: “give” masses to neutrinos and produce baryon asymmetry of the Universe

Role of the Higgs: give masses to quarks, leptons, Z and W and inflate the Universe.

Experimental and cosmological constraints

- ✓ **Recent progress in cosmology**
- ✓ *The sensitivity of previous experiments did not probe the interesting region for HNL masses above the kaon mass*
- ✓ **Use heavy flavour and W,Z decays to extend mass sensitivity reach**

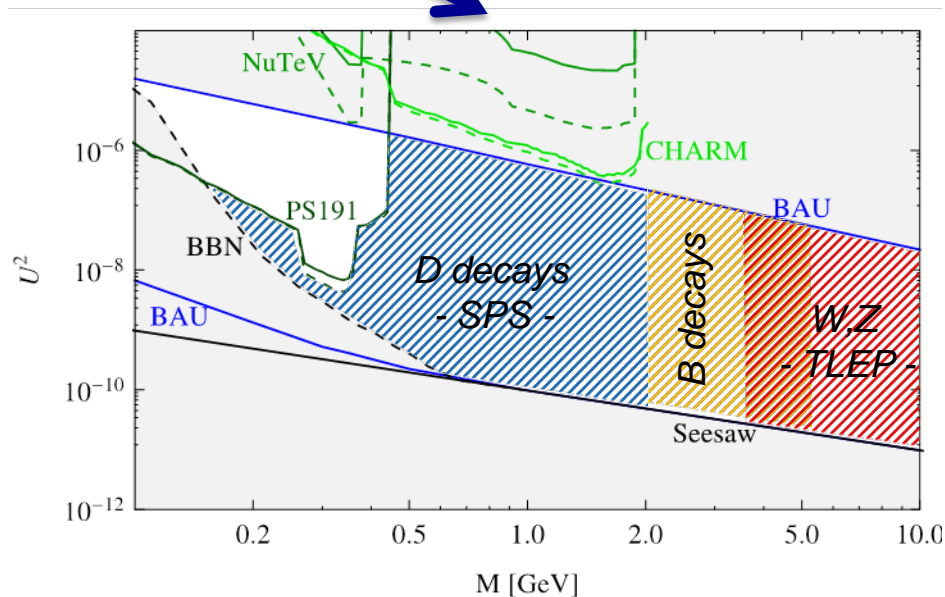
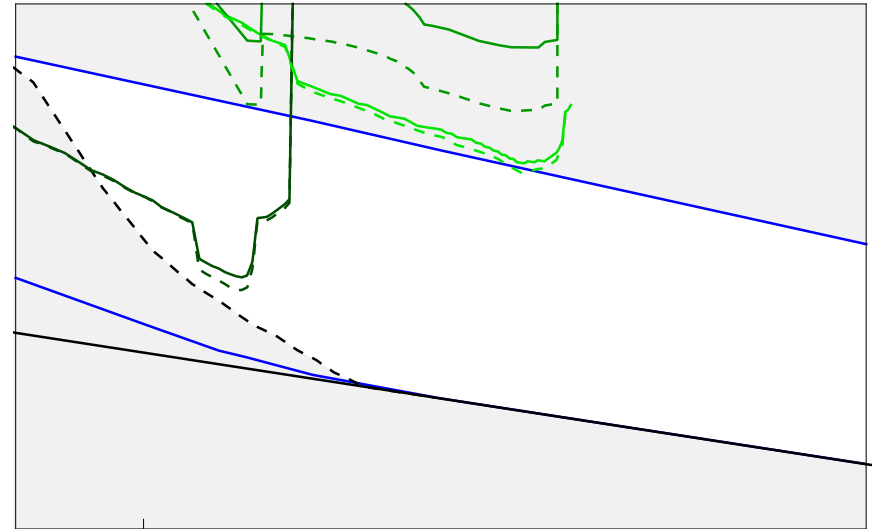

Main goal of current and near future experiments: exploration of the Fermi scale (and a bit beyond)

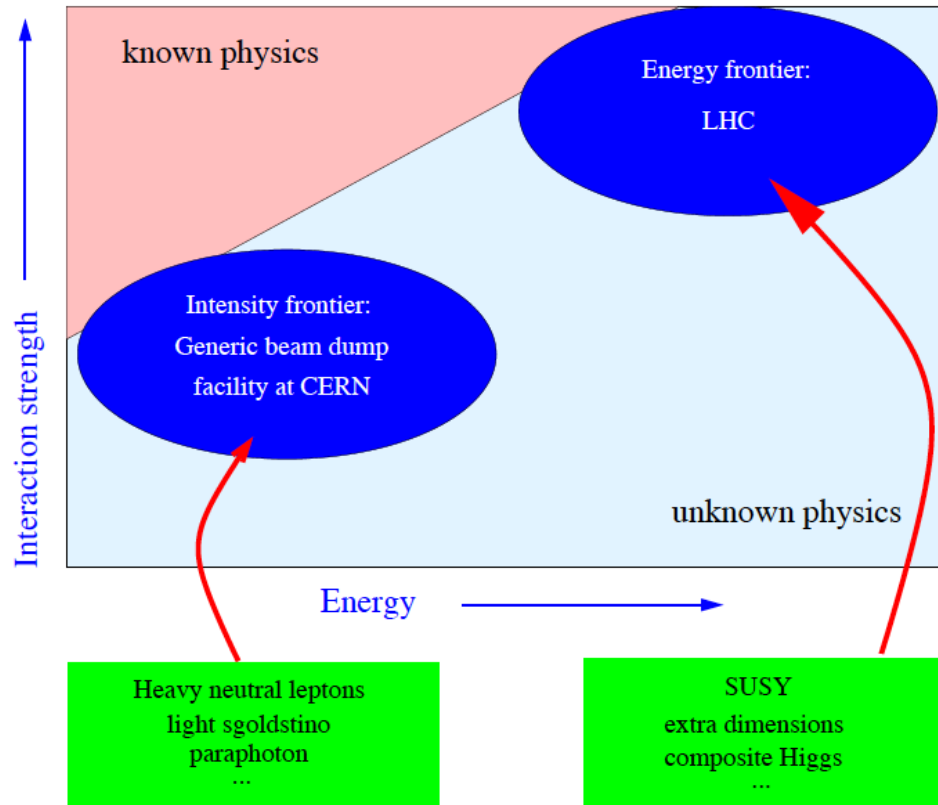

**Experiments at the both
energy and intensity
frontiers are essential !**

hidden sector:

HNL: baryon asymmetry of the Universe, dark matter, neutrino masses

sgoldstino, light neutralino: SUSY

paraphoton: mirror matter, dark matter

Energy Frontier: No sign of New Physics yet ! (or what has yet not been found)

ATLAS SUSY Searches* - 95% CL Lower Limits

Status: ICHEP 2014

ATLAS Preliminary

$\sqrt{s} = 7, 8 \text{ TeV}$

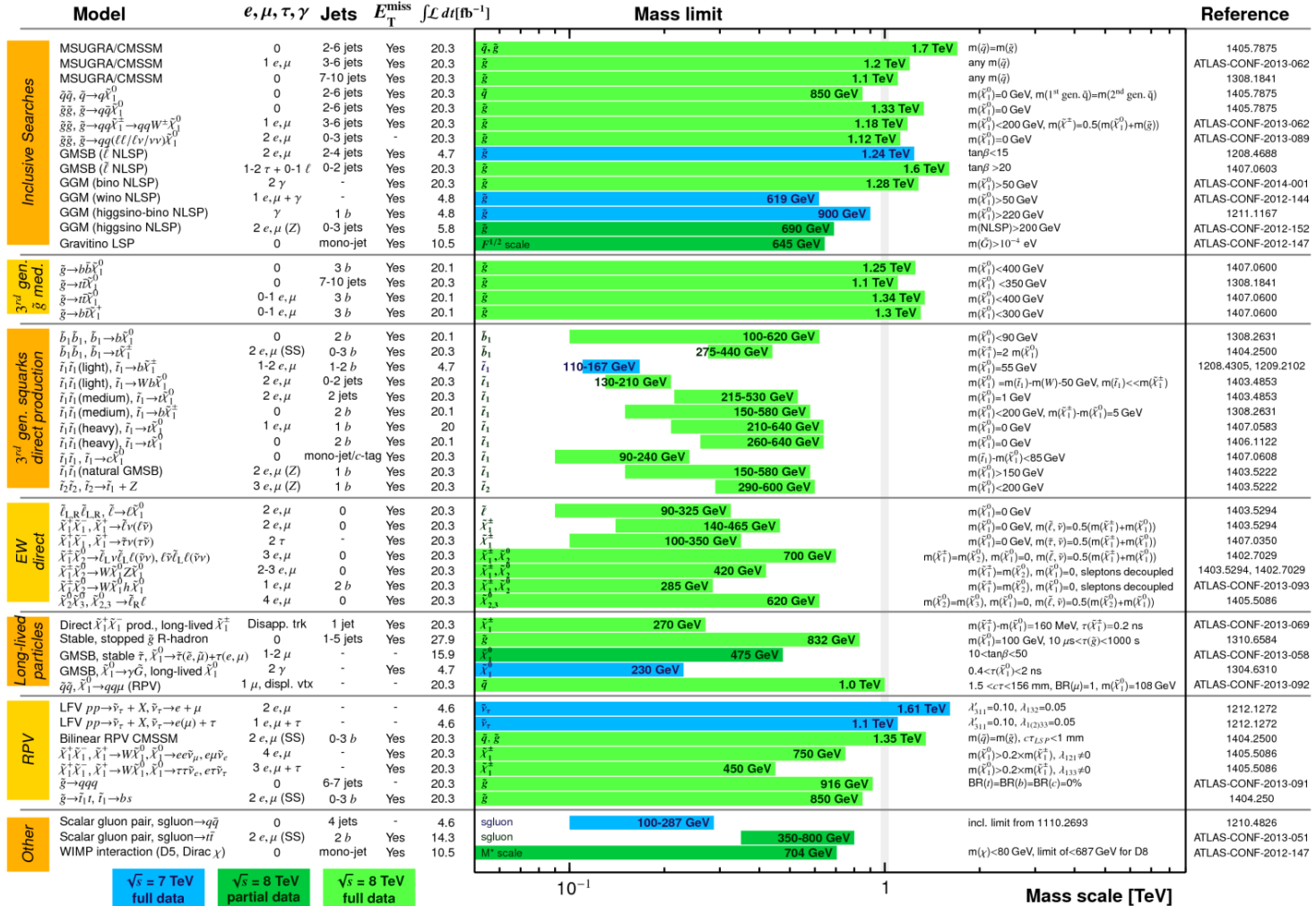

$\sqrt{s} = 7 \text{ TeV}$ full data
 $\sqrt{s} = 8 \text{ TeV}$ partial data
 $\sqrt{s} = 8 \text{ TeV}$ full data

*Only a selection of the available mass limits on new states or phenomena is shown. All limits quoted are observed minus 1 σ theoretical signal cross section uncertainty.

Wait for new LHC data at $\sqrt{s} = 13 \text{ TeV}$

Indirect bounds on the scale of New Physics

Most stringent limits come from observables in K^0 & B^0 mixing

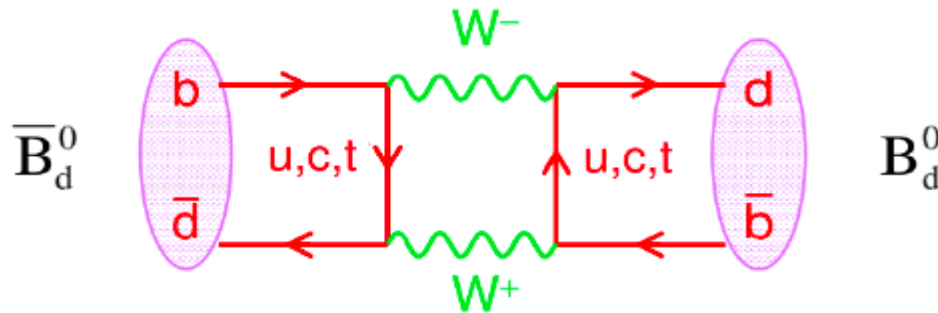

$$M(B_d^0 - \bar{B}_d^0) \sim \frac{(y_t^2 V_{tb}^* V_{td})^2}{16\pi^2 m_t^2} + c_{NP} \frac{1}{\Lambda^2}$$

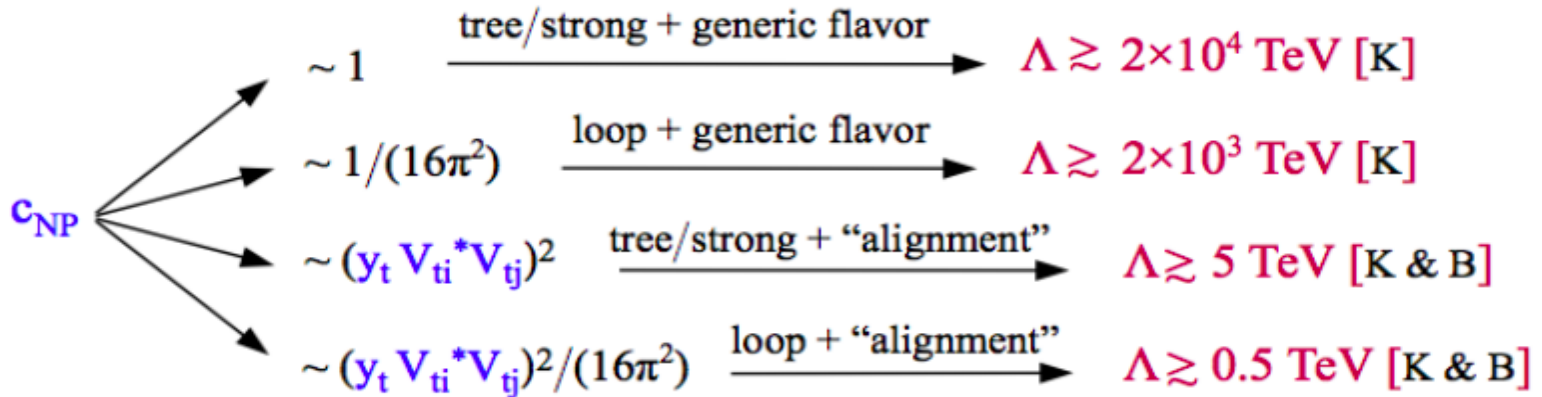
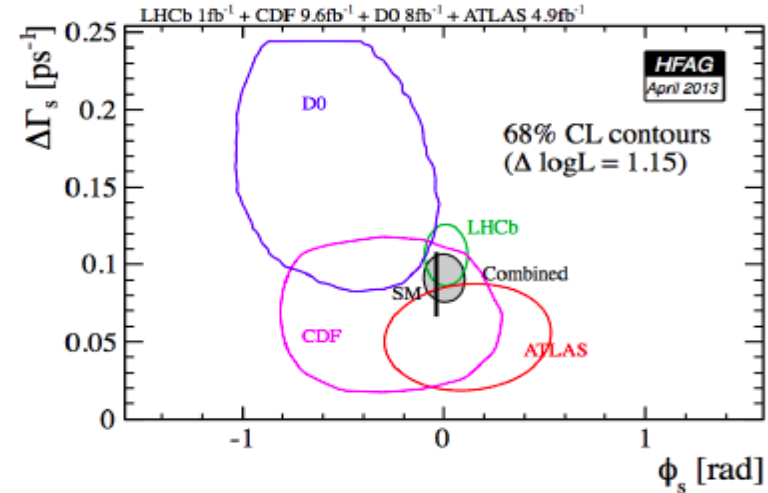

Wait for new data from LHCb, NA-62 and later from BELLE-2 and LHCb Upgrade

Search for Heavy Majorana Neutral Leptons at accelerators (recent results and future perspectives)

*M. Shaposhnikov NP B763 (2007) 45-59
A. Pilaftsis et.al. PR D72 (2005) 113001*

From cosmology: $M_N < M_W$ or $M_N \geq \approx 300$ GeV

(Sakharov condition \rightarrow CP has to be violated out of thermo-equilibrium)

✓ $M_N < M_K$

Impressive limits exist from PS-191

Will soon be validated by NA62

✓ $M_N < M_{\text{heavy flavour}}$

LHCb, BELLE

New beam-dump experiment at the SPS (SHIP) has the best sensitivity reach

✓ $M_N < M_Z$

Can be best explored at Future Circular Collider in e^+e^- mode

✓ $M_N > M_Z$

Prerogative of the ATLAS / CMS in the high luminosity phase of LHC

Intensity frontier: New fixed target facility is very timely to explore Hidden Sector and to search for HNL

Common experimental features:

✓ *Production through meson decays (π , K , D , B , proton bremsstrahlung, ...)*

✓ *Decays*

<i>Final states</i>	<i>Models tested</i>
$\pi l, Kl, \rho l, l = (e, \mu, \nu)$	ν portal, HNL, SUSY neutralino
$e^+e^-, \mu^+\mu^-$	V, S and A portals, SUSY s-goldstino
$\pi^+\pi^-, K^+K^-$	V, S and A portals, SUSY s-goldstino
$l^+l^-\nu$	HNL, SUSY neutralino

✓ *Full reconstruction and PID are essential to minimize model dependence*

✓ *Production and decay rates are strongly suppressed relative to SM*

- *Production branching ratios $O(10^{-10})$*

- *Long-lived objects*

- *Travel unperturbed through ordinary matter*

✓ ***Challenge is background suppression → requires $O(0.01)$ carefully estimated***

Physics objectives of SHiP

- ✓ *SHiP will directly search for weakly interacting New Physics*
Will exceed the sensitivity of previous experiments by a few orders of magnitude in the mass range $O(10 \text{ GeV})$

For example, probe HNL couplings close to the ultimate see-saw limit

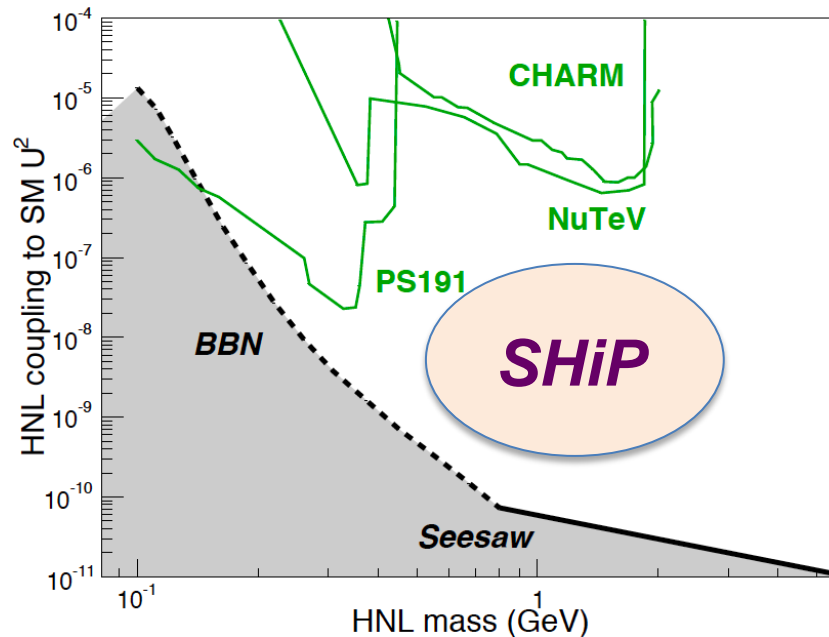

- ✓ *Unique potential to explore physics of tau neutrinos*
 - *Observe $\bar{\nu}_\tau$ for the first time*
 - *Extract F_4 and F_5 structure functions never measured so far*



- ❖ General Purpose Fixed-Target SHIP Experimental Facility
- ❖ SHIP Sensitivities to Selected Physics Channels

The Fixed-Target SHIP Facility at the SPS

Preveessin North Area Site:

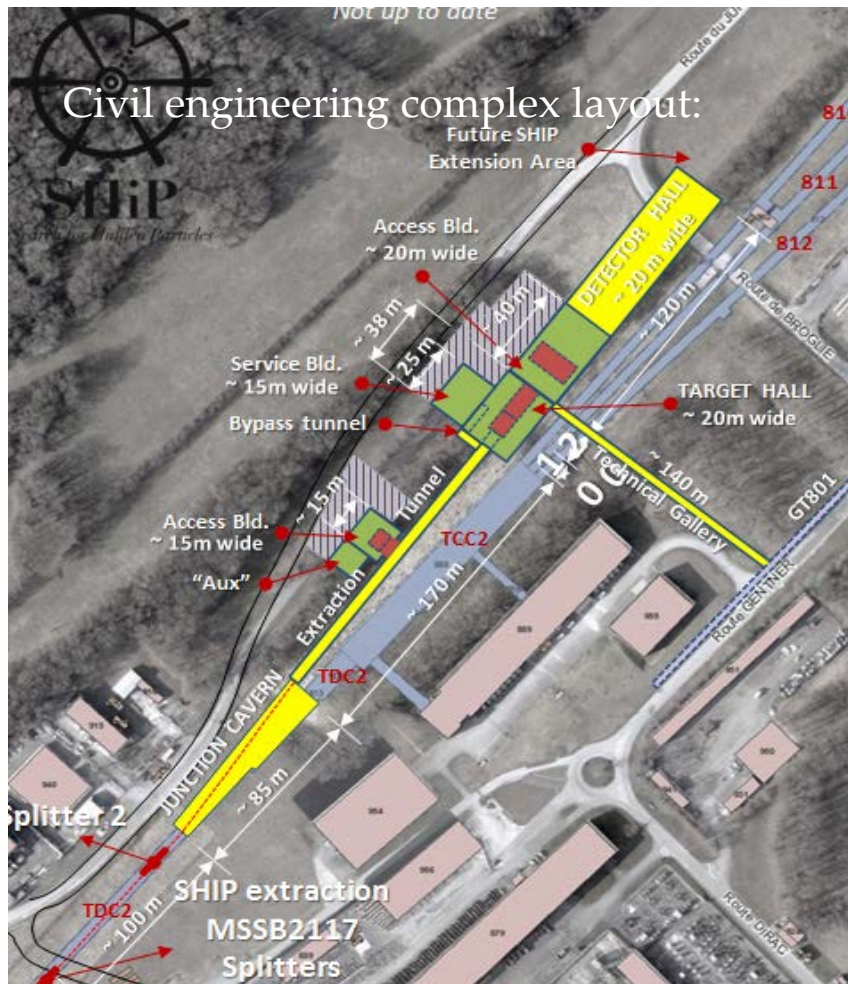

- ❖ 85m long Junction cavern in the TDC2 line
- ❖ 170 m long machine Extraction Tunnel (4 m wide by 4m high similar to TDC2)
- ❖ 15 m long by 15 m wide Access building incl. a shaft to reach the Extraction Tunnel line

Proposed location by CERN beams and support departments (TT20 transfer line):

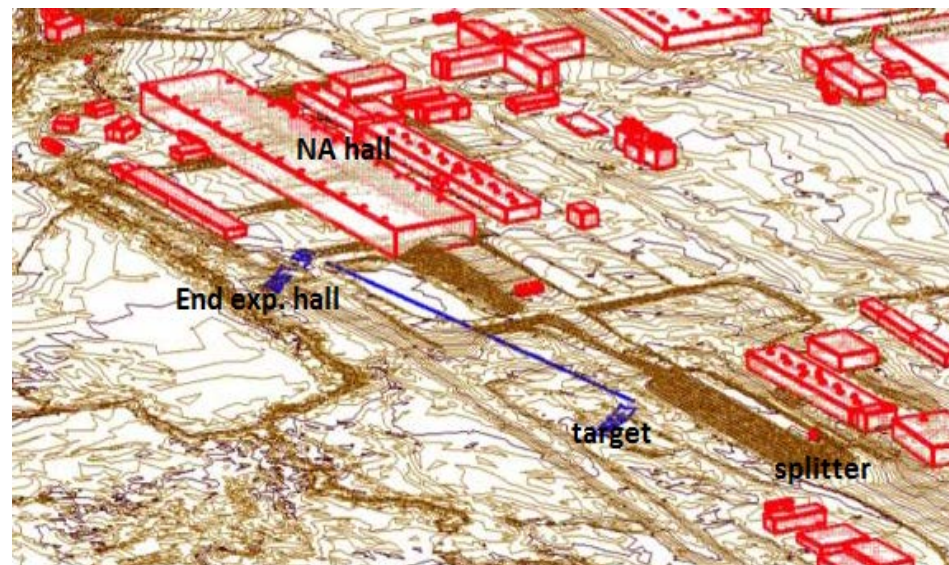
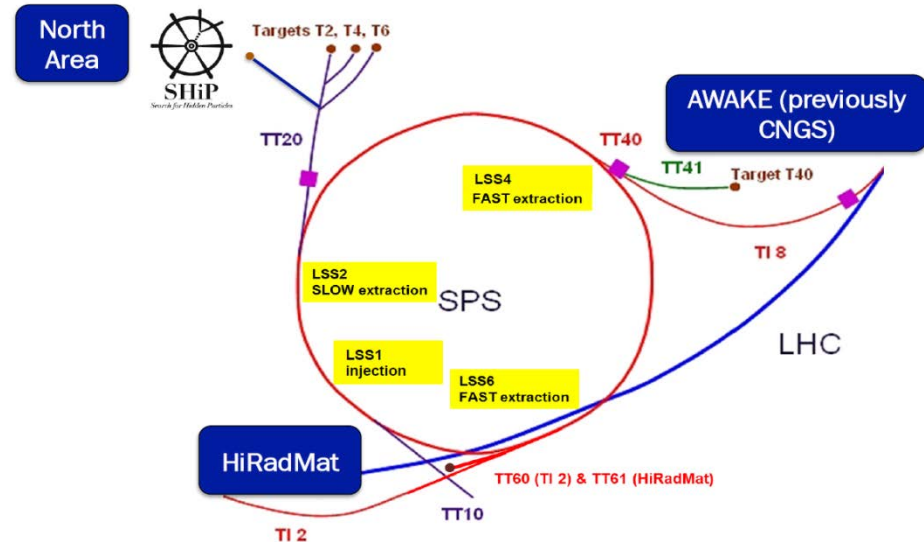

New Beam-Dump Experiment at the CERN SPS

New Intensity Frontier (SHIP Facility) at the SPS/CERN

→ Fixed-target (“beam-dump”) is an ideal instrument to search for weakly interacting Hidden Particles (HP) in Heavy Flavor Decays

SPS can provide 2×10^{20} protons on target (p.o.t.) in 5 years assuming the same operation as demonstrated during CNGS run

→ Large charm production cross section
 SPS: 4×10^{13} / 7s @ 400 GeV ($\sqrt{s} = 27$ GeV)
 → data sample of $> 10^{17}$ D-mesons

→ Side benefit: Optimizing for heavy meson decays also optimizes facility for ν_τ (ν_e, ν_μ) physics: $Br(D_s \rightarrow \tau + \nu_\tau) \sim 5.6\%$
 → data sample of $\sim 10^{15}$ τ -leptons

Comparison of SHIP with other projects:

- LHC ($\sqrt{s} = 14$ TeV): $\sim 500 \times \sigma_{cc}$ and 1 ab^{-1} (i.e. 3-4 years):
 $\sim 2 \times 10^{16}$ c-hadrons in 4π → yield factor < 100 smaller (acceptance)
- FNAL 120 GeV pot: $10 \times$ smaller σ_{cc} , $10 \times$ pot by 2025 for LBNE (?)
 HNL operation not compatible with neutrino physics

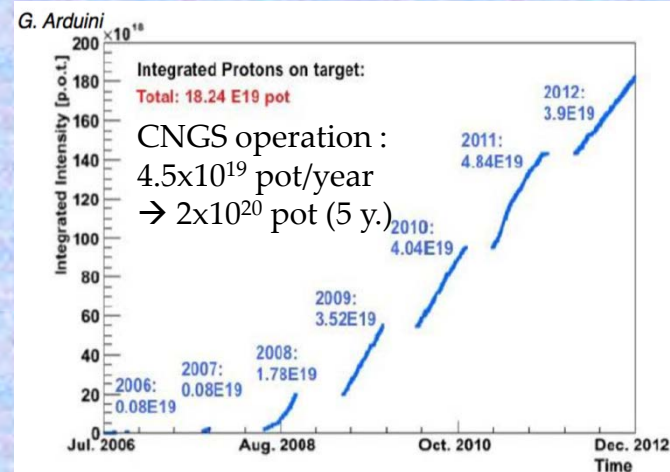
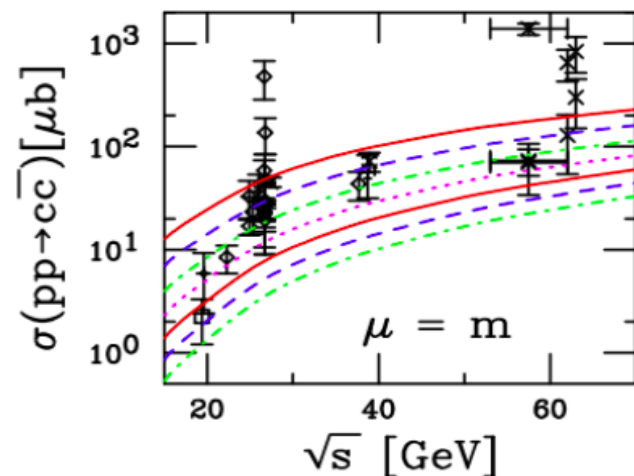

❖ Incompatible with conventional neutrino facility

❖ SHIP is a very powerful general-purpose facility for TODAY and FUTURE !

→ Full exploitation and consolidation of the SPS complex after CNGS termination

❖ Complementary physics program to searches for new physics by LHC !

SHIP Experimental Requirements / Challenges

Use of neutrino and vector portals for development of experimental facility / sensitivity studies:

- ❖ HNLs produced in charm decays have significant $P_T \rightarrow$ large detector acceptance due to boost $\tau_{N,2,3} \propto U^{-2}$, i.e. $ct \propto \mathbf{O}(\text{km})$
- Search for HNL from D-decays, i.e. $M < 2 \text{ GeV}$
- B-decays: 20-100 smaller σ ; $B \rightarrow D\mu\nu$, i.e. limited to $M \sim 5 \text{ GeV}$

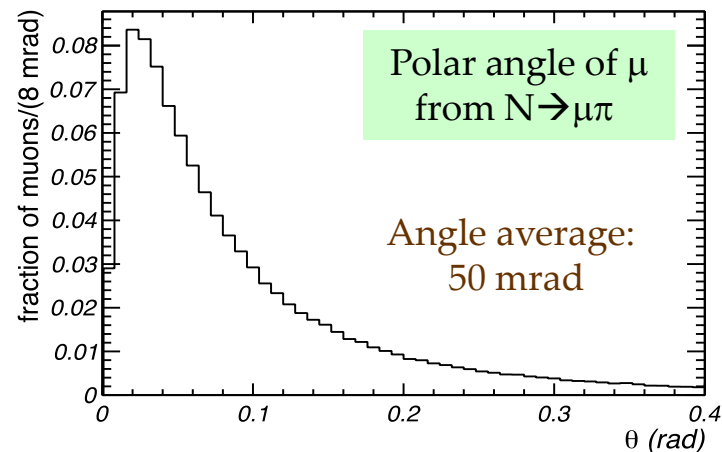
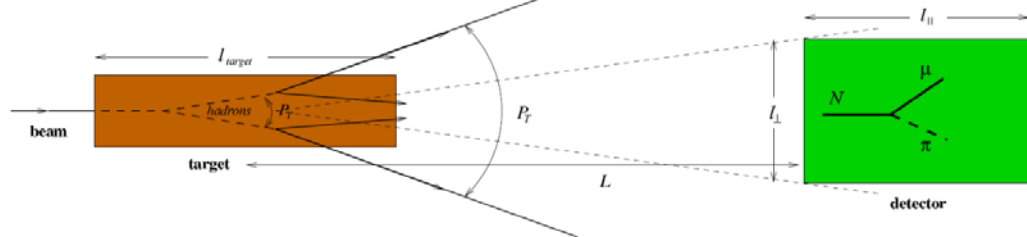

- ❖ Place detector as close as possible to target (as background allows) to maximize geometrical acceptance \rightarrow compromise between HP lifetime and production angle
- ❖ “Effective muon shield” (huge μ -flux of 5×10^9 / spill) to reduce muon-induced bkg. from short-lived resonances accompanying charm production below neutrino-background; acceptable rate $\sim 10^5 \mu$ / spill
- ❖ Decay vessel: “vacuum in detector volume” to reduce ν -interactions
- ❖ Away from cavern walls to reduce ν -interactions in detector proximity
- ❖ Magnetic spectrometer to reconstruct HNL mass.

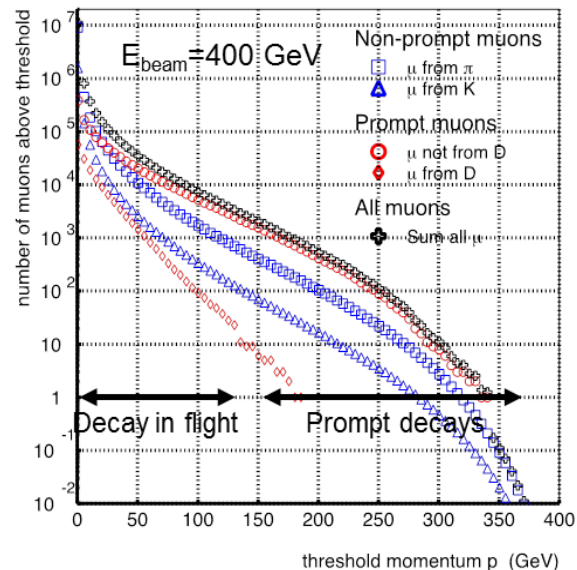

Low-p: from π/K -decay
High-p: Ω/ρ decays to $\mu\mu$

SHIP Experimental Facility: Physics Objectives

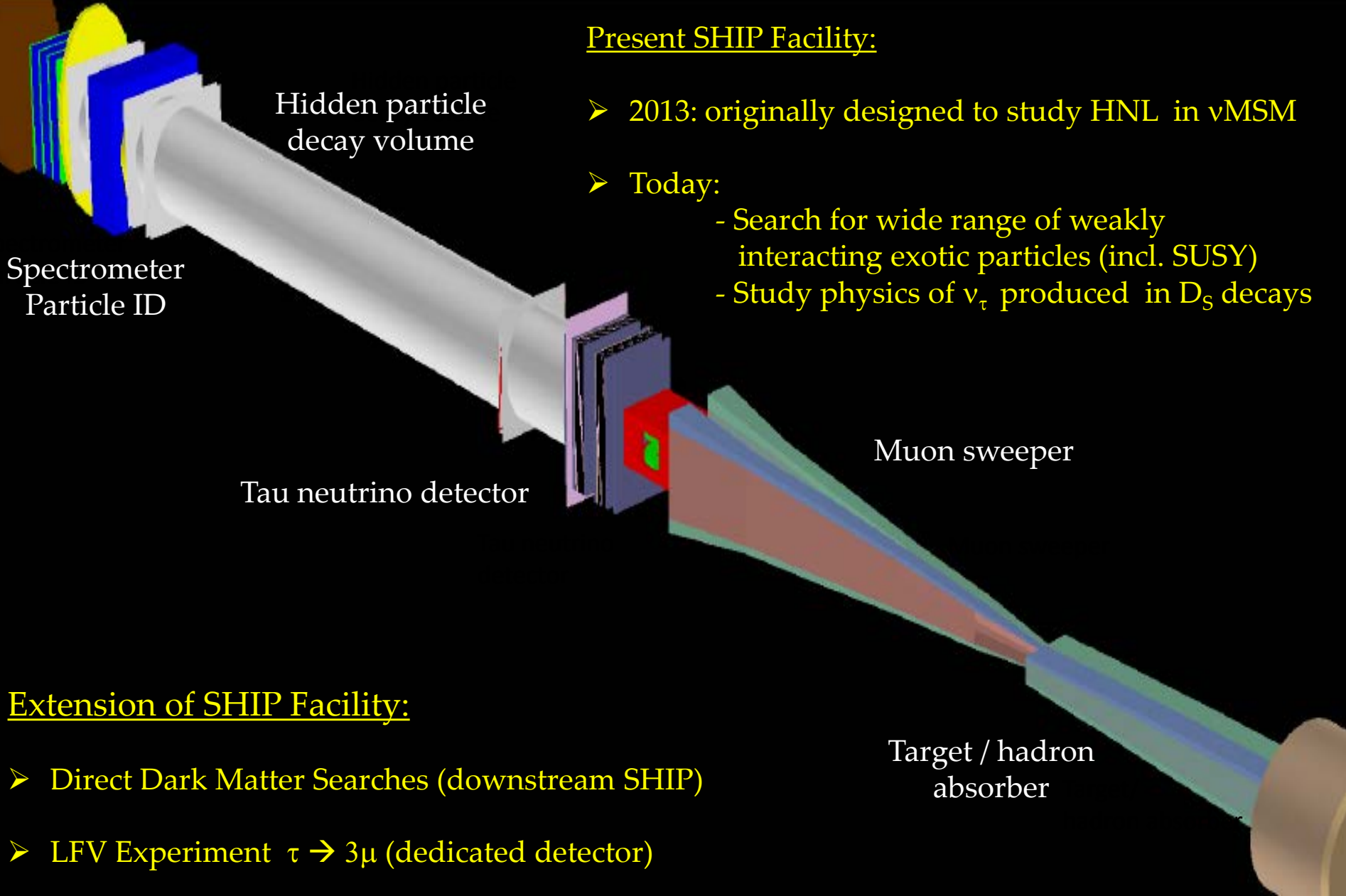

Present SHIP Facility:

- 2013: originally designed to study HNL in ν MSM
- Today:
 - Search for wide range of weakly interacting exotic particles (incl. SUSY)
 - Study physics of ν_τ produced in D_S decays

Extension of SHIP Facility:

- Direct Dark Matter Searches (downstream SHIP)
- LFV Experiment $\tau \rightarrow 3\mu$ (dedicated detector)

CERN Task Force

Initiated by CERN Management after SPSC encouragement of the SHIP in January 2014

Detailed investigation aimed at overall feasibility, identifying options/issues & resource estimate:

- Physics motivation and requirements
- Experimental Area
- SPS configuration and beam time
- SPS beam extraction and delivery
- Target station
- Civil engineering
- Radioprotection

Document completed on July 2, 2014:

- Detailed cost estimate, manpower and schedule
- Compatible with commissioning runs in 2022, data taking 2023

CERN EN Working group responsible for providing design of facility for the SHIP TP



CERN
CH1211 Geneva 23
Switzerland



Engineering Department

EDMS NO. 1369559	REV. 1.0	VALIDITY RELEASED
----------------------------	--------------------	-----------------------------

REFERENCE EN-DH-2014-007

Date : 2014-07-02

Report

A new Experiment to Search for Hidden Particles (SHIP) at the SPS North Area

Preliminary Project and Cost Estimate

The scope of the recently proposed experiment Search for Heavy Neutral Leptons, EOI-010, includes a general Search for Hidden Particles (SHIP) as well as some aspects of neutrino physics. This report describes the implications of such an experiment for CERN.

DOCUMENT PREPARED BY:
G.Arduini, M.Calviani,
K.Cornelis, L.Gatignon,
B.Goddard, A.Golutvin,
R.Jacobsson, J. Osborne,
S.Roesler, T.Ruf, H.Vincke,
H.Vincke

DOCUMENT CHECKED BY:
S.Baird, O.Brüning, J-P.Burnet,
E.Cennini, P.Chiggiato, F.Duval,
D.Forkel-Wirth,
R.Jones, M.Lamont, R.Losito,
D.Missiaen,
M.Nonis, L.Scibile,
D.Tommasini,

DOCUMENT APPROVED BY:
F.Bordry, P.Collier,
M.J.Jimenez, L.Miralles,
R.Saban, R.Trant

Schematic Principle of the SHIP Experimental Facility

Initial reduction of beam induced backgrounds:

- ❖ Heavy material target to stop pions/kaons before they decay (to minimize neutrinos from $\pi/K \rightarrow \mu\nu$)
→ blow up beam to dilute energy on target
- ❖ Slow (and uniform) beam extraction → reduce occupancy / combinatorial background
- ❖ Hadron Absorber
- ❖ Active Muon Filter → muon flux limit is driven by emulsion based neutrino detector and HP background
- ❖ Vacuum decay volume followed by a Hidden Sector detector measuring the HNL decay products

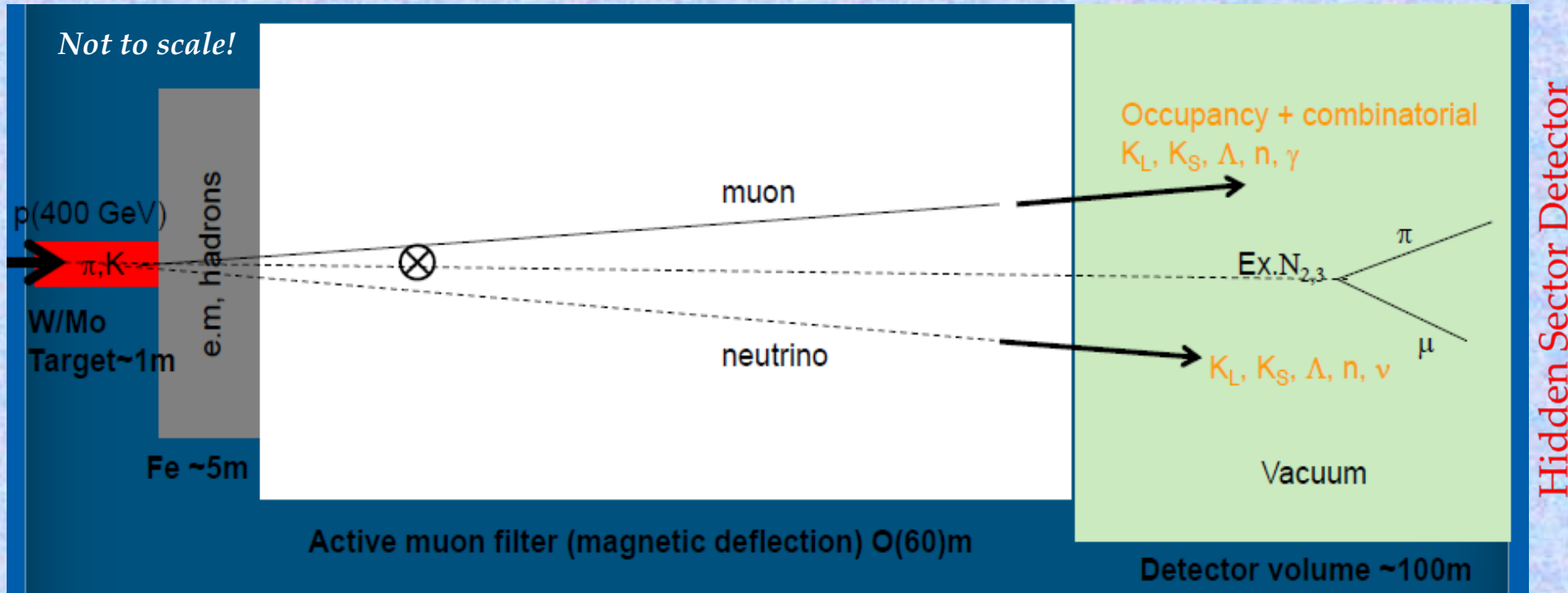

Hidden Sector detector optimization: beam energy / intensity, detector acceptance, background studies with full detector simulation → design virtually background free experiment O (0.1 event)

SHIP Target and Target Complex

Design consideration: 4×10^{13} p / 7s \rightarrow ~ 350 kW

- ❖ Longitudinally segmented hybrid target (1.2 m length, 0.3×0.3 m² transverse) with H₂O cooling
- ❖ High T / Compressive stresses (400 MPa)
- ❖ Erosion / Corrosion
- ❖ Material properties as a function of irradiation
- ❖ Remote handling (Initial dose rate of 50 Sv/h...)

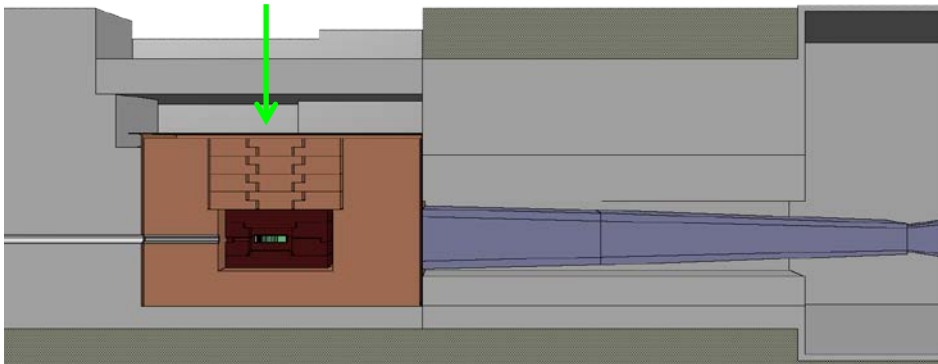

	DONUT *	CHARM **	SHIP
Target material	W-alloy	Cu (variable ρ)	TZM + pure W
Momentum (GeV/c)	800	400	400
Intensity	0.8×10^{13}	1.3×10^{13}	4×10^{13}
Pulse length (s)	20	23×10^{-6}	1
Rep. rate (s)	60	~ 10	7.2
Beam energy (kJ)	1020	830	2560
Avg. beam power (spill) (kW)	51	3.4×10^7 (fast)	2560
Avg. beam power (SC) (kW)	17	69	355
POT	Few 10^{17}	Few 10^{18}	2×10^{20}

Target Complex:

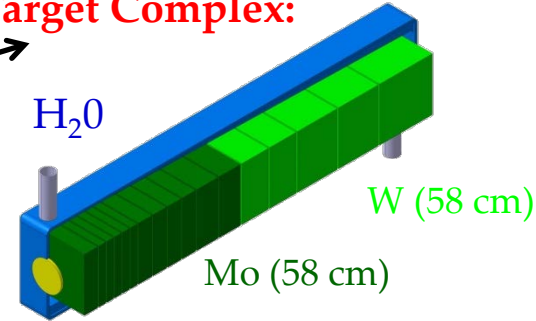

Energy density per spill:

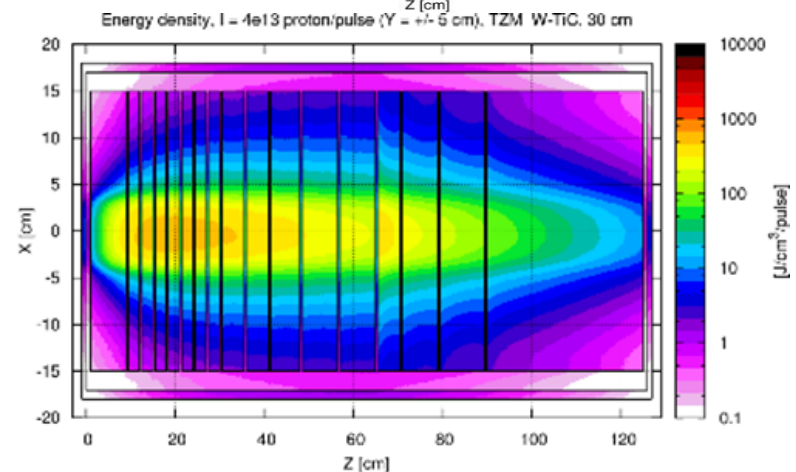
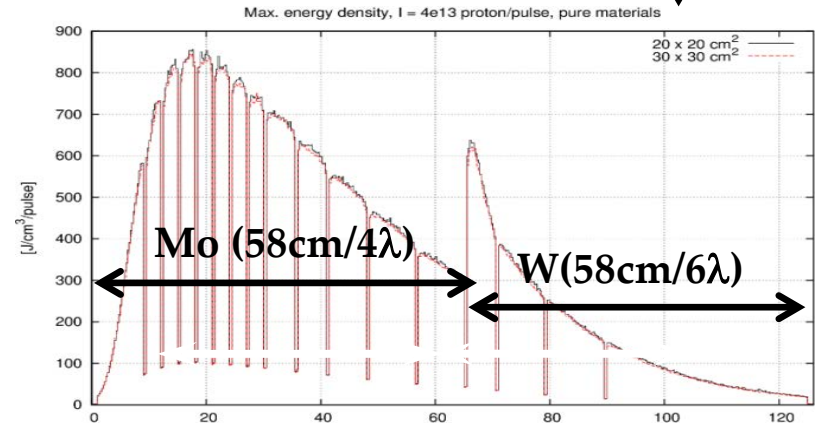

Active Muon Shield

Baseline: Active muon shield based entirely on magnet sweeper / passive absorber

Conceptual design:

- ❖ Need around 40 Tm of field to bend out the highest momenta muons ($E_\mu \sim 350$ GeV)
- ❖ Return field of the magnets tends to bend low-energy muons back towards the detector
- ❖ Critical idea – use a first magnet to separate μ^+ and μ^- away from z-axis and then place the return field there \rightarrow “wings” critical to design

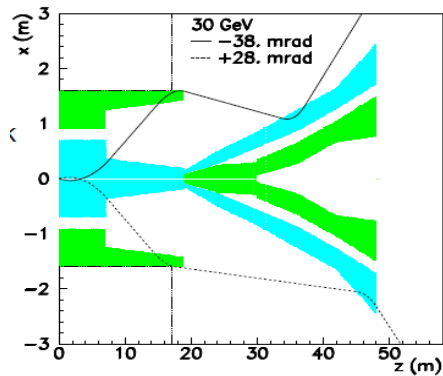

Field, +ive B_y , 1.8 T
Return field, -ive B_y , 1.8 T

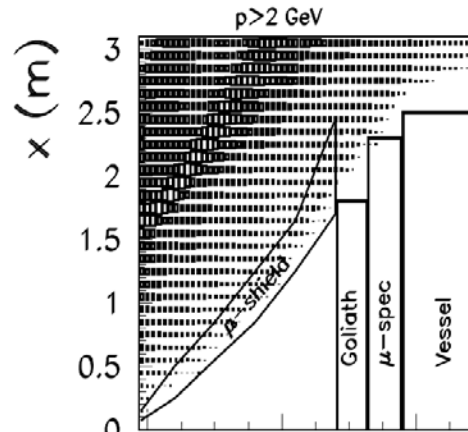

- ❖ Realistic design of sweeper magnets in progress. \rightarrow Challenges: flux leakage, constant field profile, modelling magnet shape

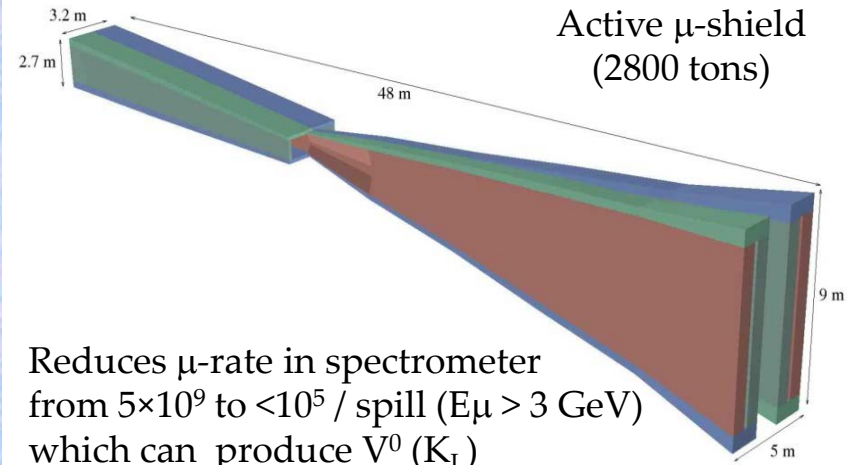

Reduces μ -rate in spectrometer from 5×10^9 to $< 10^5$ / spill ($E_\mu > 3$ GeV) which can produce V^0 (K_L)

Prompt dose rates in the experimental hall 4x13 p.o.t. / 7s

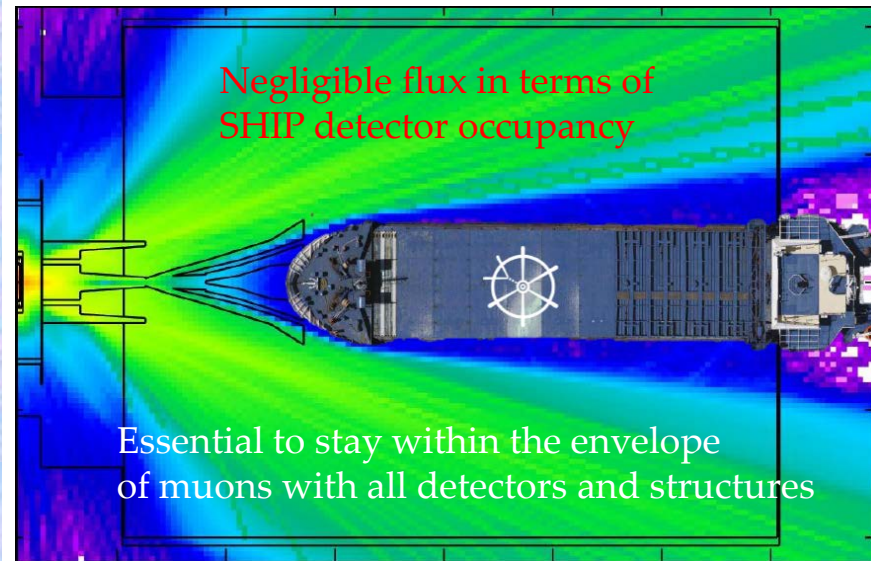

Essential to stay within the envelope of muons with all detectors and structures

SHIP Experimental Facility: Main Parameters

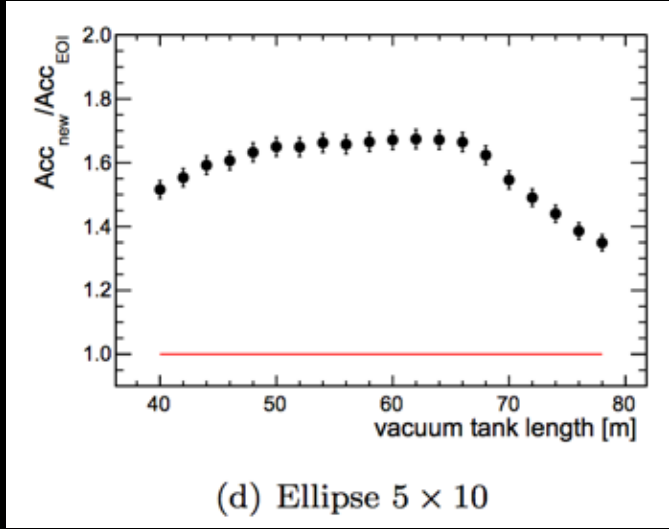
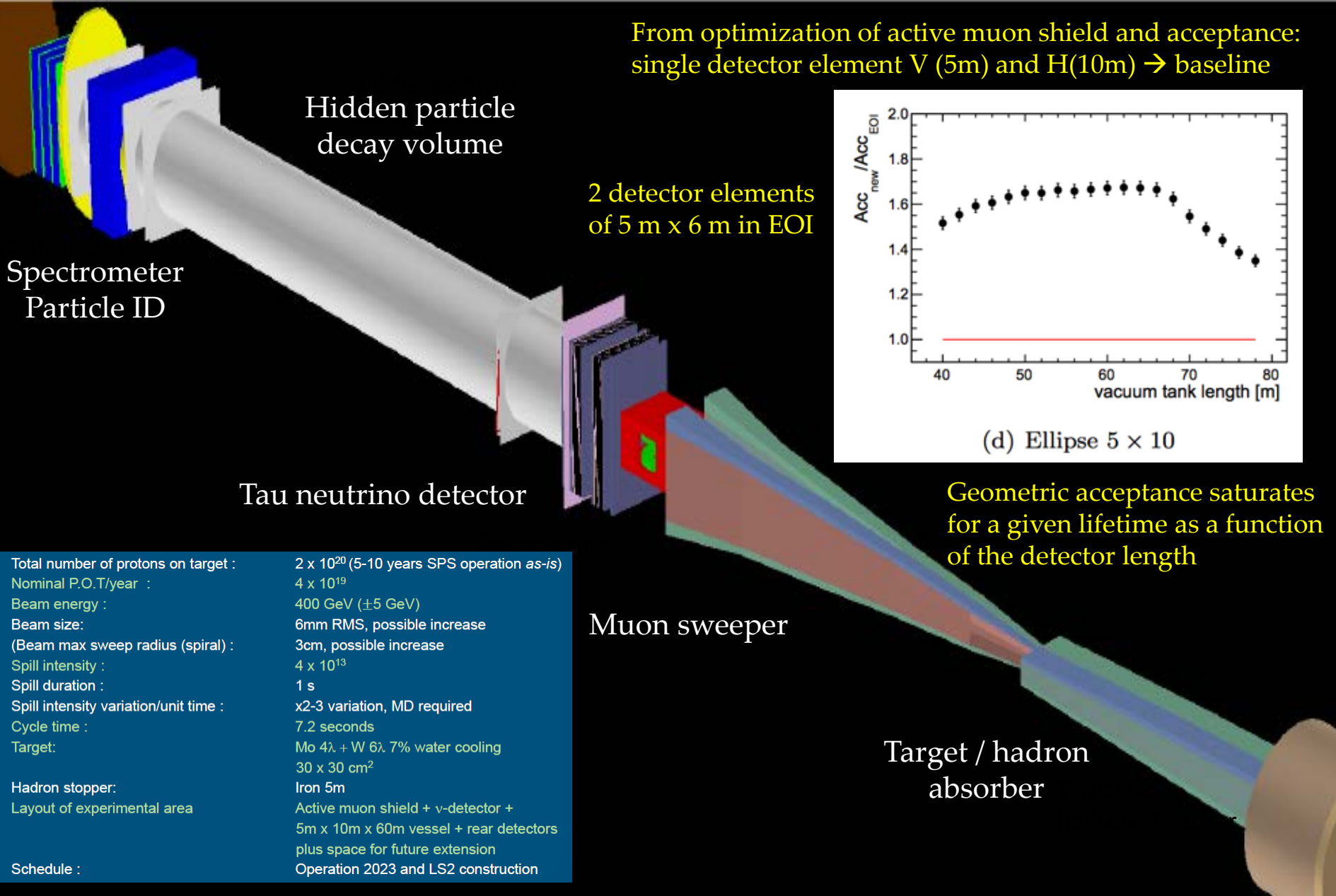

• Total number of protons on target :	2×10^{20} (5-10 years SPS operation <i>as-is</i>)
• Nominal P.O.T/year :	4×10^{19}
• Beam energy :	400 GeV (± 5 GeV)
• Beam size:	6mm RMS, possible increase
• (Beam max sweep radius (spiral) :	3cm, possible increase
• Spill intensity :	4×10^{13}
• Spill duration :	1 s
• Spill intensity variation/unit time :	x2-3 variation, MD required
• Cycle time :	7.2 seconds
• Target:	Mo 4λ + W 6λ 7% water cooling 30 x 30 cm ²
• Hadron stopper:	Iron 5m
• Layout of experimental area	Active muon shield + ν-detector + 5m x 10m x 60m vessel + rear detectors plus space for future extension
• Schedule :	Operation 2023 and LS2 construction

Hidden Sector Detector: Objectives and Requirements

Direct detection of Hidden Sector Portals:

→ Full reconstruction / tracking and particle identification of final states with e, μ, π^\pm, γ (π^0, ρ^\pm), (ν), and decays in flight

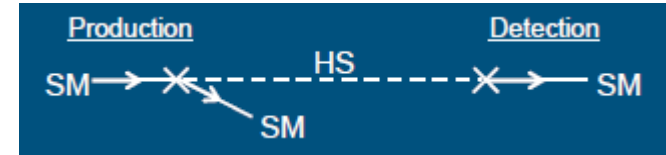

Cosmologically interesting and experimentally accessible $m_{HS} \sim 100 \text{ MeV} - 10 \text{ GeV}$:

- Sensitivity to as many modes as possible – model independence
- Ultimately distinguish between models

Models tested	Final states
Neutrino portal, SUSY neutralino	$l\pi, lK, l\rho \quad l = (e, \mu, \nu)$
Vector, scalar, axion portals, SUSY sgoldstino	$e^+e^-, \mu^+\mu^-$
Vector, scalar, axion portals, SUSY sgoldstino	$\pi^+\pi^-, K^+K^-$
Neutrino portal, SUSY neutralino, axino	$l^+l^-\nu$
Axion portal, SUSY sgoldstino	$\gamma\gamma$
Axino	$\gamma \dots$
SUSY sgoldstino	$\pi^0\pi^0$

Residual backgrounds sources:

- ❖ Neutrino inelastic scattering (e.g. $\nu/\mu + p \rightarrow X + K_L \rightarrow \mu p \nu$) → detector under vacuum, accompanying charged particles (tagging, timing), topological
- ❖ Muon inelastic scattering → accompanying charged particles (tagging, timing), topological
- ❖ Muon combinatorial (e.g. $\mu\mu$ with μ mis-ID) → Tagging, timing and topological
- ❖ Neutrons → Tagging, topological
- ❖ Cosmics → Tagging, timing and topological

X refers to fragmentation products which may help to tag these interactions:

Background source	Decay modes
ν or $\mu + \text{nucleon} \rightarrow X + K_L$	$K_L \rightarrow \pi e \nu, \pi \mu \nu, \pi^+\pi^-, \pi^+\pi^-\pi^0$
ν or $\mu + \text{nucleon} \rightarrow X + K_S$	$K_S \rightarrow \pi^0\pi^0, \pi^+\pi^-$
ν or $\mu + \text{nucleon} \rightarrow X + n$	$n \rightarrow pe^-\bar{\nu}_e$
ν or $\mu + \text{nucleon} \rightarrow X + \lambda$	$\lambda \rightarrow p\pi^-$
n or $p + \text{nucleon} \rightarrow X + K_L$, etc	As above

Fraction of particles entering the vacuum vessel

Per ν_μ CC interaction:

Particle	Fraction _{Entering}
Neutron	1.98
Λ	3.6×10^{-6}
K_S^0	3.6×10^{-6}
K_L^0	0.5%

Combination of light and highly efficient taggers surrounding vacuum vessel (both the sides and the front face) are required

Vacuum Vessel ("Decay Volume")

- ✓ Estimated requirement for vacuum: 10^{-2} mbar
 - Based on ν -flux: 2×10^4 ν -interactions per 2×10^{20} p.o.t. at $p_{\text{atm.}}$. Negligible at 0.001 mbar
 - Design with factor 10 flexibility and factor 10 safety margin: 10^{-4} mbar

- ✓ Vacuum vessel ("double-wall structure"):
 - 10 m (vertical) x 5 m (horizontal) x 62 m (length);
 - Walls thickness: 8 mm (Al) / 30 mm (SS);
 - Walls separation: 100 mm;
 - Liquid scintillator volume: ~ 120 m³;
 - 1500 WOMs (8 cm x \varnothing 8 cm Wavelength Shifting Optical Modules + PMTs);
 - Metal weight (stainless steel, no support): ~ 480 t.

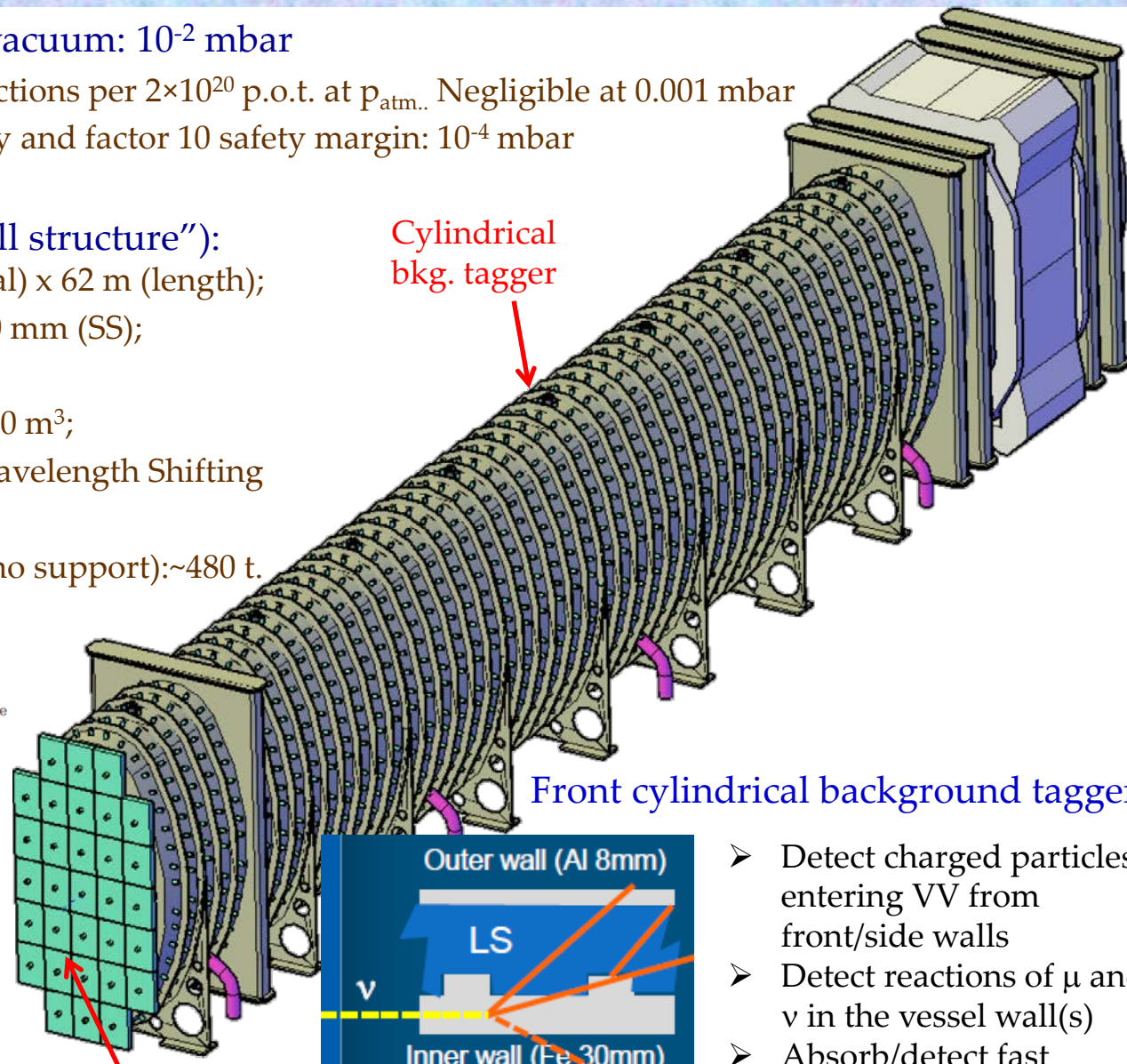

LS cell with WOMs ("ICECUBE Technique):

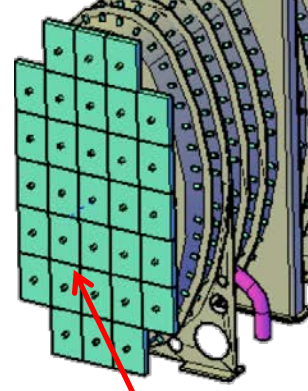
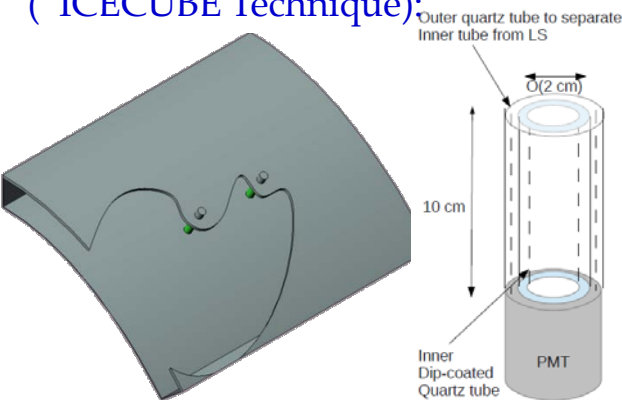

Front bkg. tagger

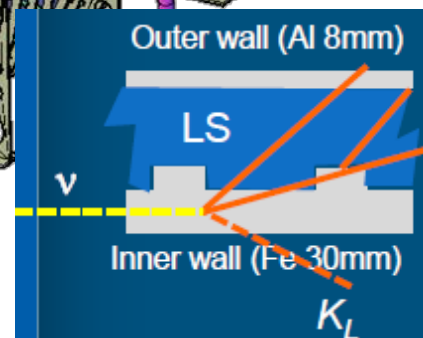

Front cylindrical background tagger:

- Detect charged particles entering VV from front/side walls
- Detect reactions of μ and ν in the vessel wall(s)
- Absorb/detect fast neutrons before entering the VV

LAB (Linear alkyl benzene)	-
2.5 diphenyl oxazole (PPO)(C ₁₅ H ₁₁ NO)	3g/l

Hidden Sector Detector Concept (based on existing technologies)

Reconstruction of HP decays in various final states:

- ✓ 50 m long decay volume ("vacuum vessel") → background from active ν -interactions negligible at 10^{-3} mbar
- ✓ 10 m long magnetic spectrometer with 0.5 Tm dipole magnet and 4 low material tracking chambers (straws in vacuum)
- ✓ ECAL/HCAL and MUON systems outside vacuum with infrastructure walls away to reduce ν - μ interactions in proximity of detector

Background Suppression (under study):

- ✓ Cylinder bkg tagger → double wall with liquid-scintillator housed in between vacuum vessel
- ✓ Front bkg tagger → front window with liquid/plastic scintillator
- ✓ Downstream high resolution timing detector based on MIP calorimeters
- ✓ (Upstream in-vacuum veto chamber) aimed at high efficiency of $> 99\%$ and 1 ns time resolution
- ✓ (Muon System of neutrino detector)

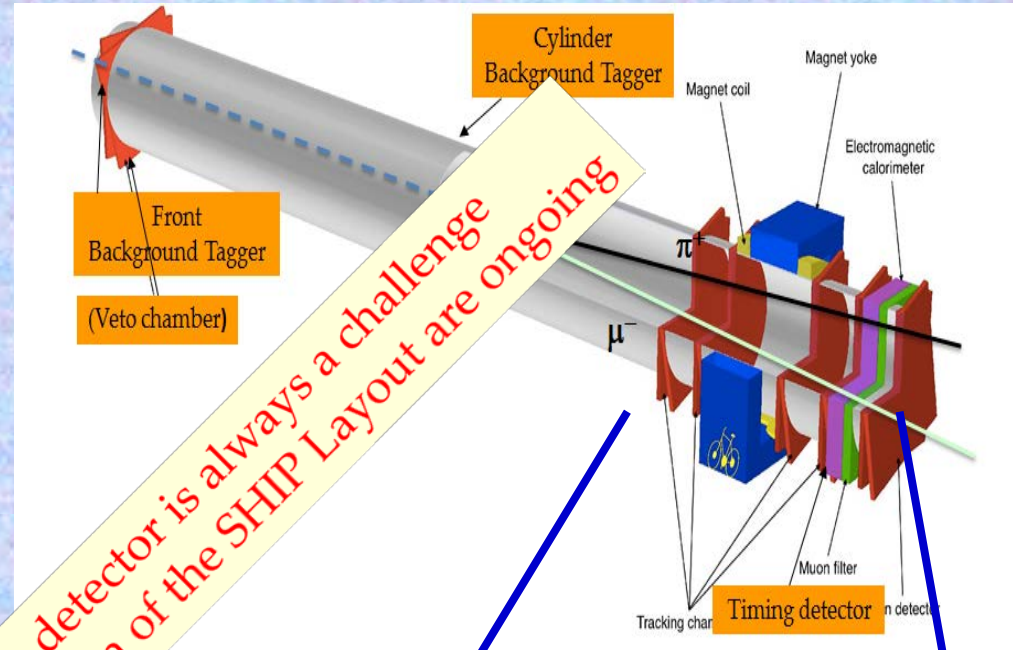

Designing background-free detector is always a challenge
 Full simulation and optimization of the SHIP Layout are ongoing

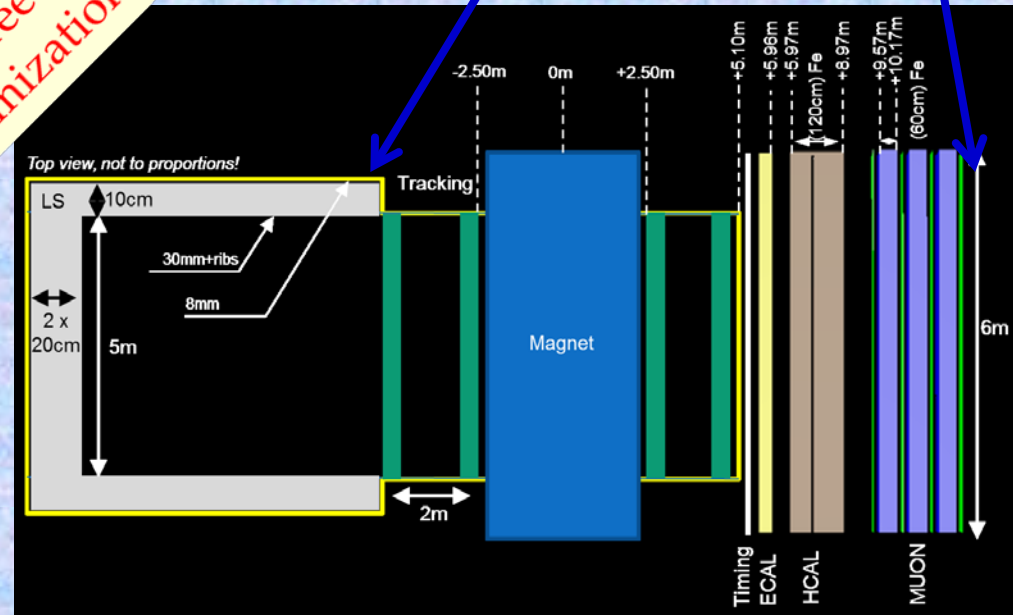

Hidden Sector Detector Layout : Overview of Technologies

TRACKER: NA62-like straw chambers in vacuum (10^{-3} mbar), 120 μm spatial resolution, 0.5% X/X_0 for 4 stations



Magnetic spectrometer

- emphasize on lower power < 1 MW
- design for modest 0.5 Tm with upgrade up to 1 Tm

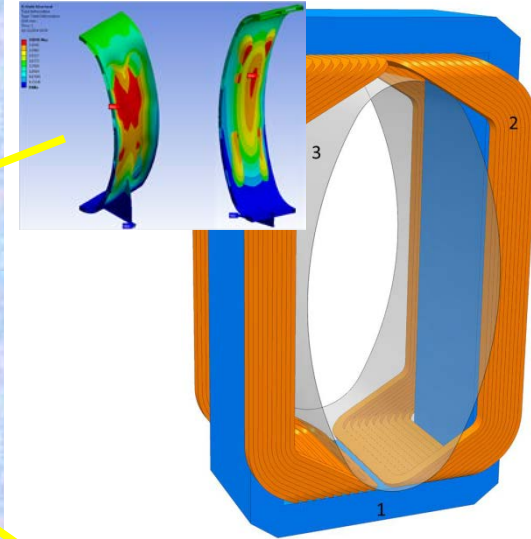

Timing Detector: < 100 ps resolution MPRC or Sci. bars with WLS-SiPM (ALICE, NA61, MINOS)

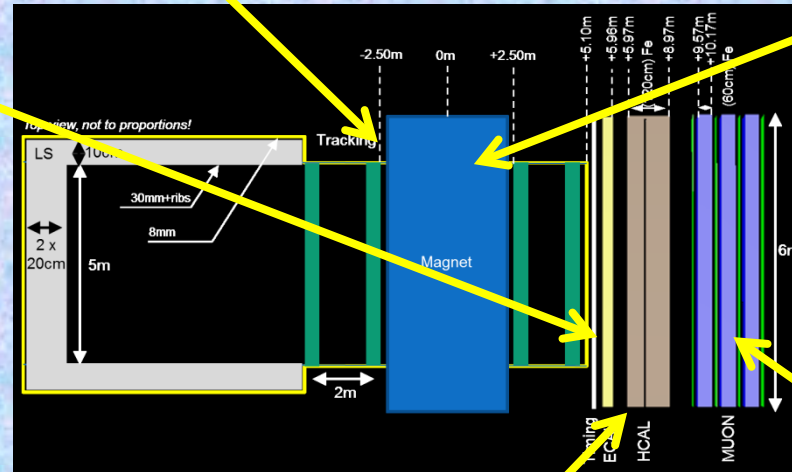
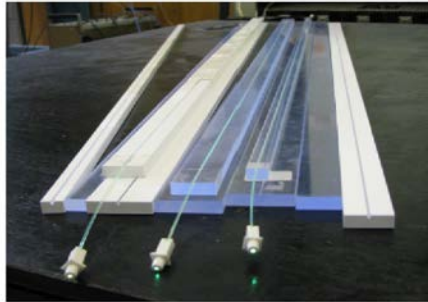

ECAL/HCAL: spiral shashlik CALO (HERA-B, LHCb)

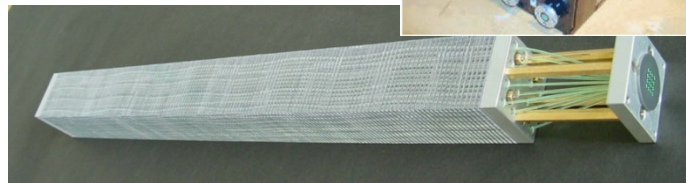

MUON: Sci. bars / WLS fibres (e.g. MINOS) and SiPMs readout

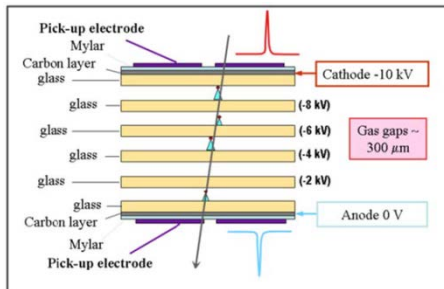
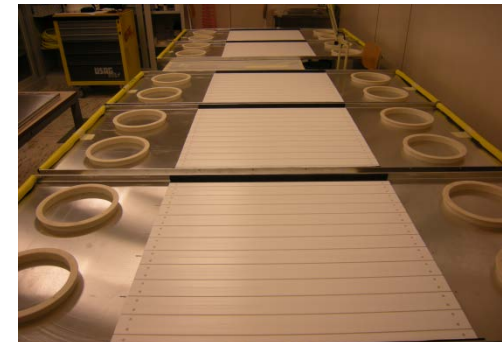

SAMPIC Chip for the ECAL Calorimeter and Timing Detector

Collaborative effort between CEA and LAL:

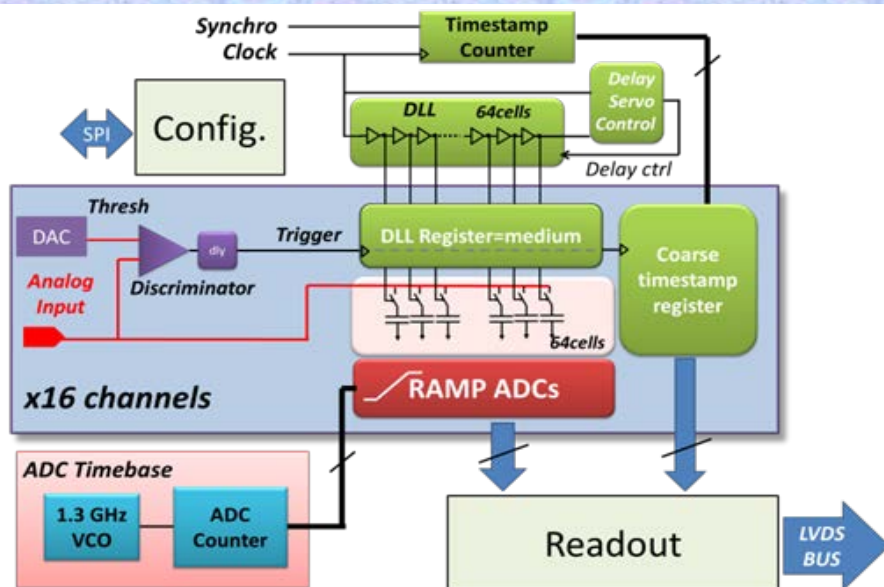

SAMPIC chip can be used for:

- The TIMING detector requires ~ 50 ps resolution \rightarrow corresponds exactly to the initial target of SAMPIC. The expected rate is several orders of magnitude smaller than the limit of SAMPIC.
- The ECAL calorimeter using scintillators read by PMT \rightarrow SAMPIC can be used in the low-speed mode with a timing resolution far better < 0.5 ns required and allowing to fully capture pulses as long as 60 ns. Some optimization to the current SAMPIC chip for bi-gain operation is mandatory.

Potential interests of the French groups:

- ❖ Electronics developments: SAMPIC or others (Irfu, LAL, LPNHE)
- ❖ Micromegas detector for Tau Neutrino target tracker (Irfu)
- ❖ VETO photodetector (LPNHE)



Schematic Principle of the Experimental Facility

Initial reduction of beam induced backgrounds:

- ❖ Heavy material target to stop pions/kaons before they decay (to minimize neutrinos from $\pi/K \rightarrow \mu\nu$)
→ blow up beam to dilute energy on target
- ❖ Slow (and uniform) beam extraction → reduce occupancy / combinatorial background
- ❖ Hadron Absorber
- ❖ Active Muon Filter → muon flux limit is driven by emulsion based neutrino detector and HP background
- ❖ Tau neutrino detector located immediately downstream of active muon shield

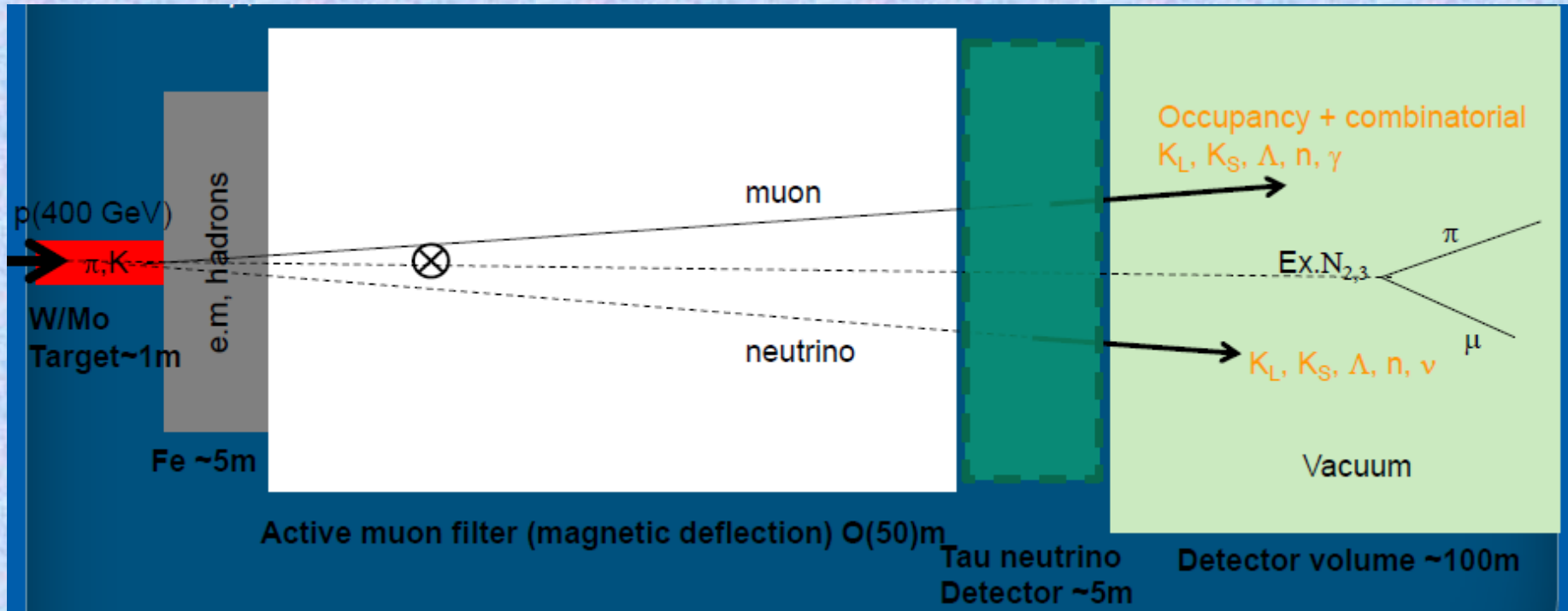

Tau neutrino detector optimization: negligible occupancy, emulsion limit of 10^4 particles /mm², ideally suited for studying interactions of ν_τ , observation of the production and decay of charm

Tau Neutrino Detector Layout

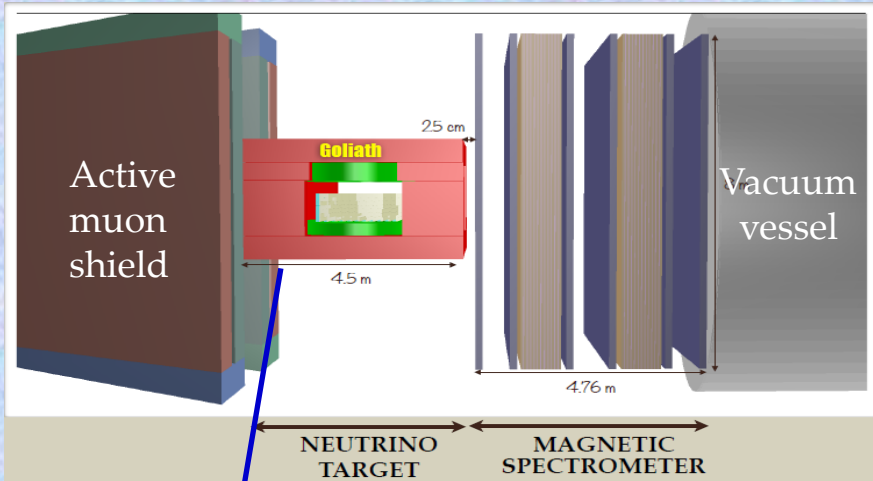

- ❖ High spatial resolution to observe the τ decay ($\sim 1\mu\text{m}$)
→ **EMULSION FILMS**
- ❖ Electronic detectors to give “time” resolution to emulsions
→ **ELECTRONIC TARGET TRACKER PLANES**
- ❖ Magnetized target to measure charge of τ -products
→ **GOLIATH MAGNET**
- ❖ Magnetic spectrometer to perform muon identification and measure its charge and momentum
→ **MUON SPECTROMETER**

B-field in emulsion and muon-filters in μ -spectrometer: distinguish ν_τ / from anti- ν_τ

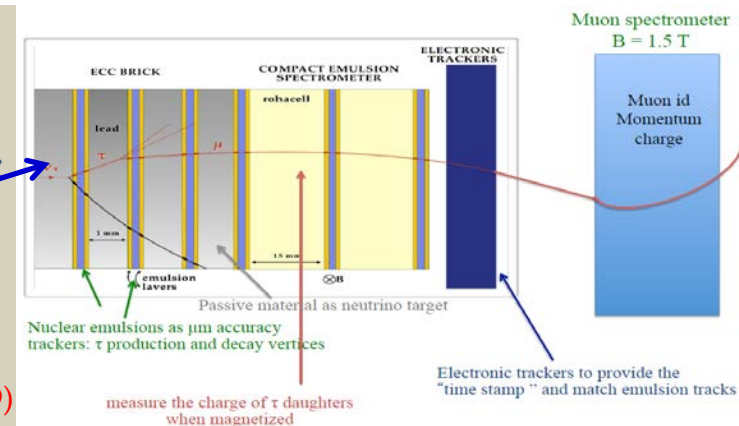
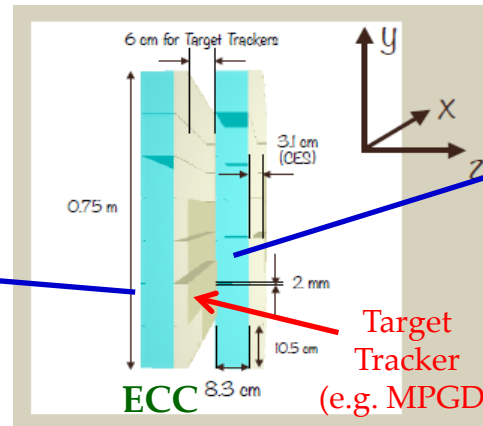
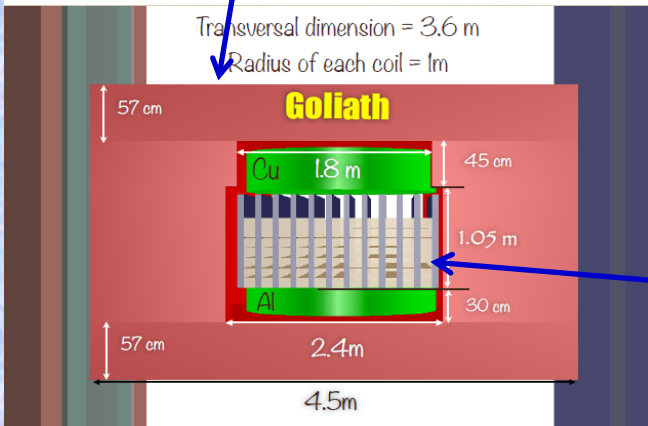

Neutrino target:

- 1155 ECC bricks to be replaced 10 times
- 260 n-interactions integrated in 1 ECC brick (during 6 months exposure)
- Total emulsion surface: 8700 m² (5% OPERA)

- ❖ **Emulsion Cloud Chamber (ECC)**
→ Passive material (Lead 1mm) - 56 layers
→ High resolution (Nuclear emulsions) - 57 films
- ❖ **Compact Emulsion Spectrometer:**
→ 3 OPERA-like emulsion films
→ 2 Rohacell spacers (low density material)

Electronic Target Tracker for the Tau Neutrino Detector

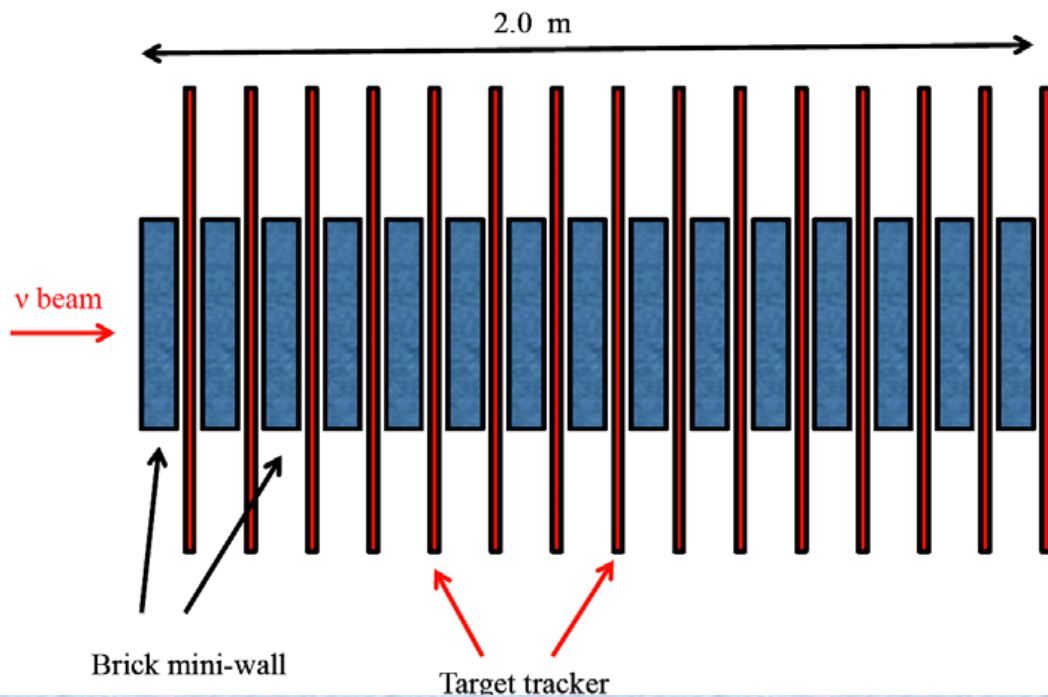

Target Tracker Requirements:

- Maximum thickness of the plane is 5-6 cm with small dead space (< 1 mm)
- Spatial resolution ($\sim 100\mu\text{m}$) and its angular dependence
- Capability of measuring the angle in each plane (efficiency versus the track angle: up to $\text{tg}(\theta) = 1$)
- Performance in magnetic field (RD51 is currently using GOLIATH magnet in the test-beam area);

Target Tracker Layout:

- 12 planes with $2 \times 1 \text{ m}^2$ surface
- Provide time stamp of the neutrino interaction in the brick"
- Matching between the electronic detectors and the emulsion tracker

Three possible technologies:

- ❖ Scintillating fiber tracker (250 μm scintillating fibres readout by SiPMs)
- ❖ GEM / Micromegas tracker

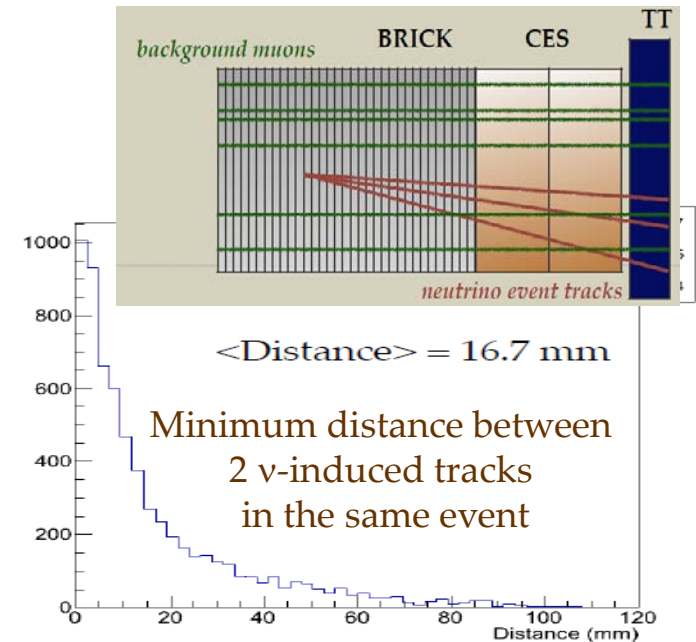

- Min distance $< 200 \mu\text{m} = 0.5\%$

all electrons / positrons

Micromegas for Target Tracker (based on ATLAS NSW Experience)

~2x1 m² MM can be built as a single module with min. dead space : ~ 1-strip pitch (300 μ m) on each PCB

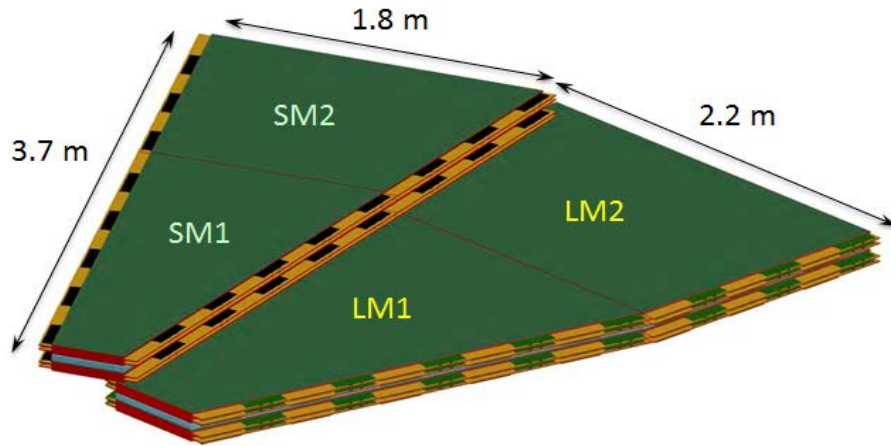

4-plet thickness total budget (ATLAS NSW -7.8 cm \rightarrow to be reduced by 20-30% or use 3-plet of MM chambers)

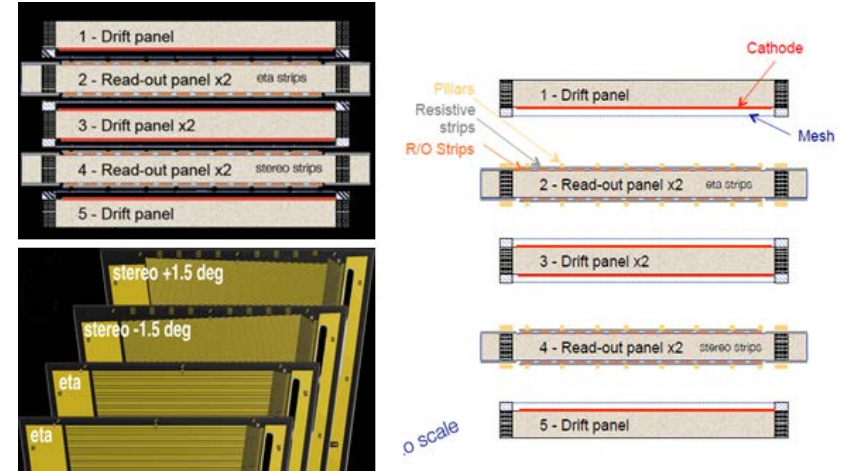

Measuring the arrival time of the signals opens a new dimension; in this case the MM functions like a TPC \Rightarrow Track vectors/plane for inclined tracks

$\sigma < 100 \mu$ m independently of track incident angle!

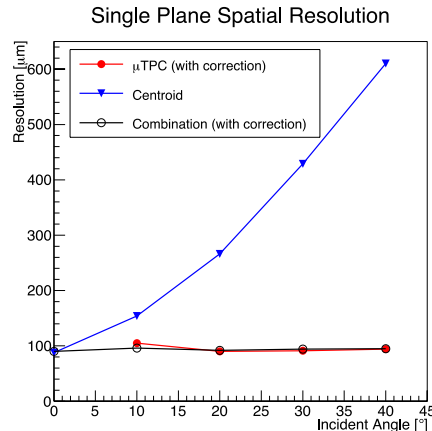
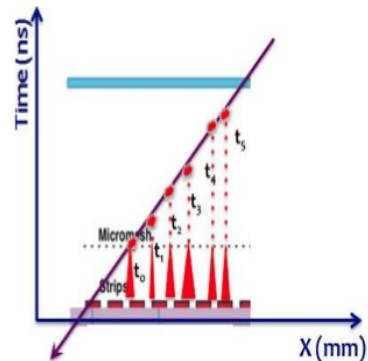

Cost Effective Solution (compared to fiber tracker):
~40 kEUR for one MM module (i.e. for 4 layers of ~3 m² MM plane within a module) without electronics

MM spatial resolution:
Strip pitch ~ 400-450 μ m
Strip width ~ 300 μ m

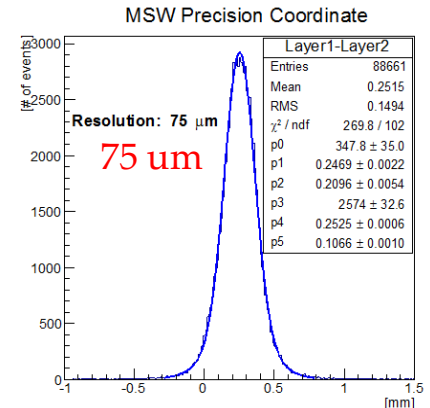
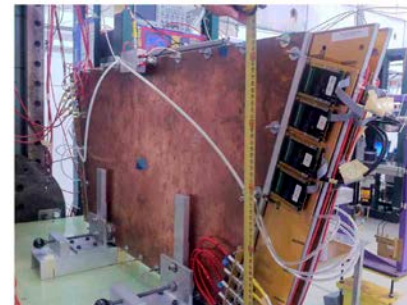

SM Physics with SHIP: ν_τ -Factory With Lowest Background

✓ Expect $O(10000) \nu_\tau / \bar{\nu}_\tau$ interactions in 6 tons emulsion target with 2×10^{20} pot

Prospects for ν_τ (ν_e, ν_μ) Physics :

- First observation of anti- ν_τ
- Unique opportunity to measure ν_τ / anti- ν_τ cross-sections differentially
- Extraction of F_4, F_5 structure functions from CC-neutrino nucleon scattering (not accessible with lighter neutrinos)
- Charm physics with ν and anti- $\nu \rightarrow$ anti- ν highly sensitive to the s-quark (improve understanding of the strange quark content of nucleons)
- Study of ν_e at high energies ($E > 20$ GeV)
- Exotic states searches (e.g. multi-quark)
- Measurement of the ν_e production in charmed decays \rightarrow normalization for long-lived hidden particle searches

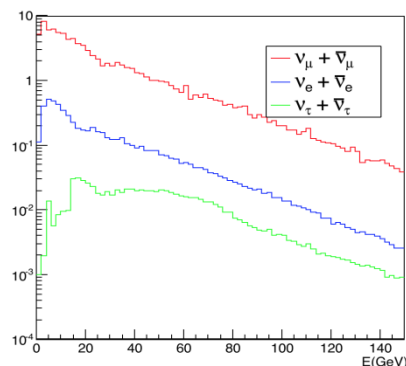

CC interacting ν -fluxes and spectra:

	$\langle E \rangle$ (GeV)	# interactions
ν_μ	29	3.4×10^6
ν_e	33	2.3×10^5
ν_τ	48	2.4×10^4
$\bar{\nu}_\mu$	23	1.1×10^6
$\bar{\nu}_e$	33	8.5×10^4
$\bar{\nu}_\tau$	48	1.2×10^4

Neutrino-induced charm production:

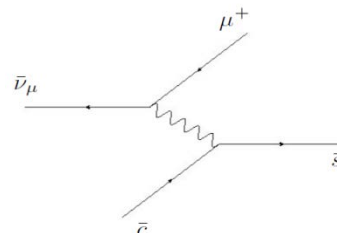

	$\langle E \rangle$ (GeV)	# interactions
ν_μ	30.3	7.2×10^4
ν_e	42.5	3.3×10^4
anti- ν_μ	26.7	2.4×10^4
anti- ν_e	33.6	2.9×10^4

Separate contributions of valence (absent in anti- ν case) and sea quarks: 30-2000 \times CHORUS statistics

Exotic state searches (e.g. pentaquark)

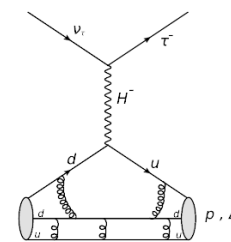
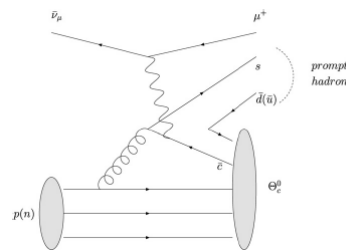

SHIP Sensitivities for selected physics channels

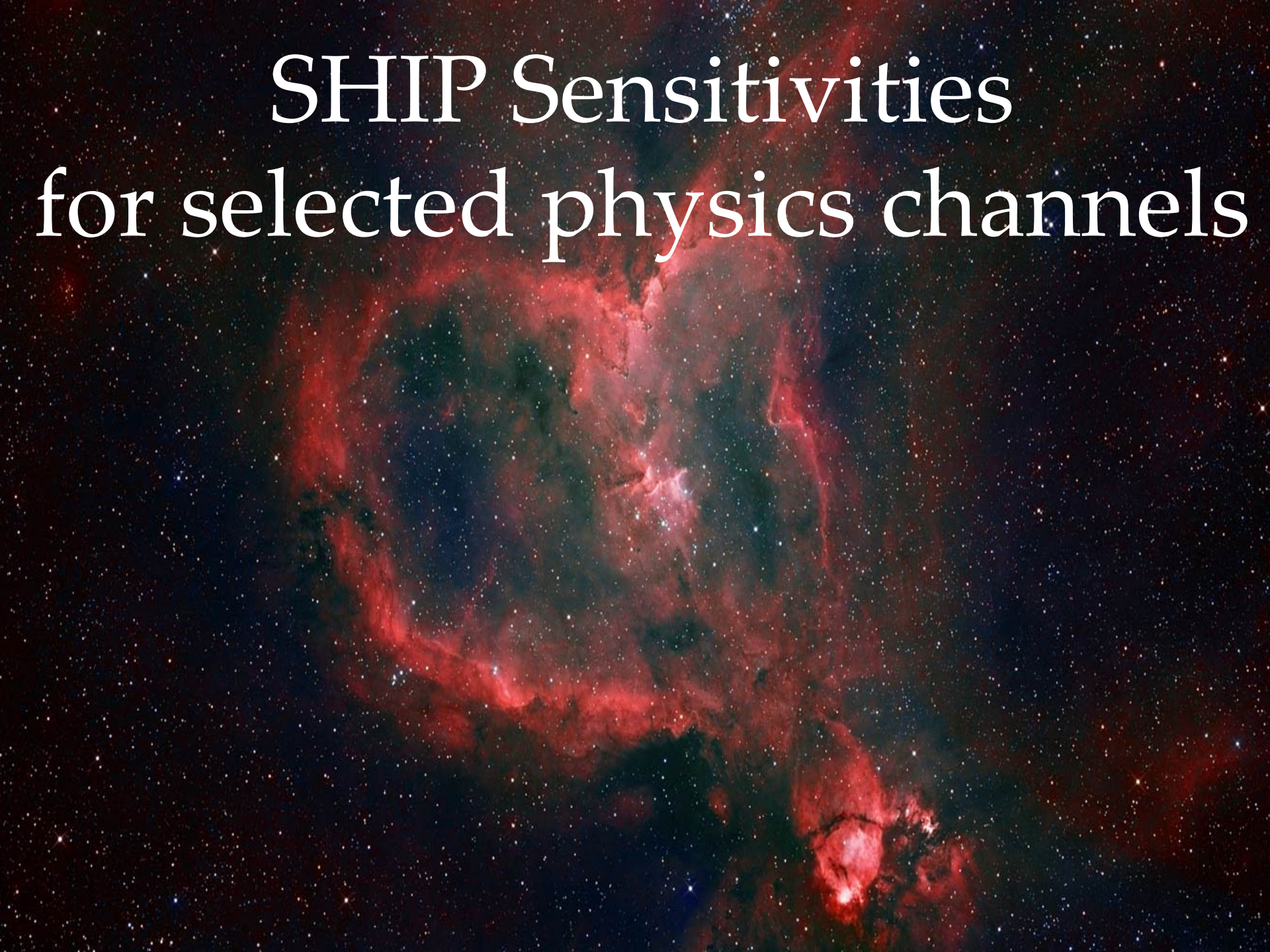

Physics Case for the General Beam Dump Facility

Different portals to Hidden sectors:

Portal	Particles	Operator(s)
“Vector”	Dark photons	$-\frac{\epsilon}{2\cos\theta_W} B_{\mu\nu} F'^{\mu\nu}$
“Axion”	Pseudoscalars	$\frac{a}{f_a} F_{\mu\nu} \tilde{F}^{\mu\nu}, \frac{a}{f_a} G_{i\mu\nu} \tilde{G}^{\mu\nu}, \frac{\partial_\mu a}{f_a} \bar{\psi} \gamma^\mu \gamma^5 \psi$
“Higgs”	Dark scalars	$(\mu S + \lambda S^2) H^\dagger H$
“Neutrino”	Sterile neutrinos	$y_N L H N$

Long lived weakly interacting particles:

- ❖ Heavy masses, O(100 GeV): ATLAS and CMS via missing ET
- ❖ Small masses, O(1-10 GeV): LHC-b, B-factories, direct observ., large couplings = short lifetimes
- ❖ **Small masses, O(1 GeV), small couplings = long lifetimes: SHiP**

Neutrino Portal: Sensitivity to Heavy Neutral Leptons ($N_{2,3}$) in ν MSM

Sensitivity based on current SPS with 2×10^{20} *p.o.t.* (~ 5 years of CNGS-like operation)
 (Visible decays = at least two tracks crossing the spectrometer)

SHiP will scan most of the cosmologically allowed region below the charm mass:

Benchmark scenario (II):

$\rightarrow \sim 120$ events for $M_{N_{2,3}} = 1$ GeV in cosmologically favoured region: $U_\mu^2 = 10^{-8}$ and $\tau_N = 180 \mu\text{s}$

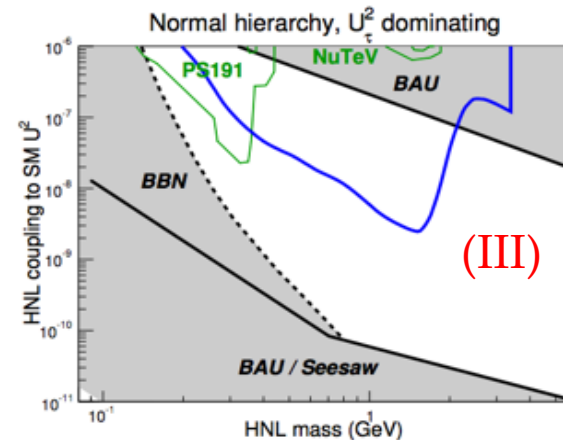
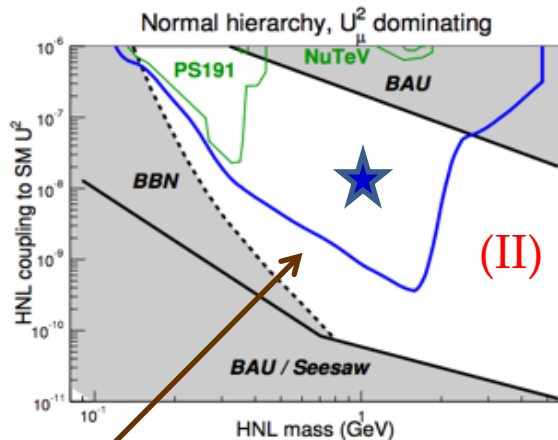
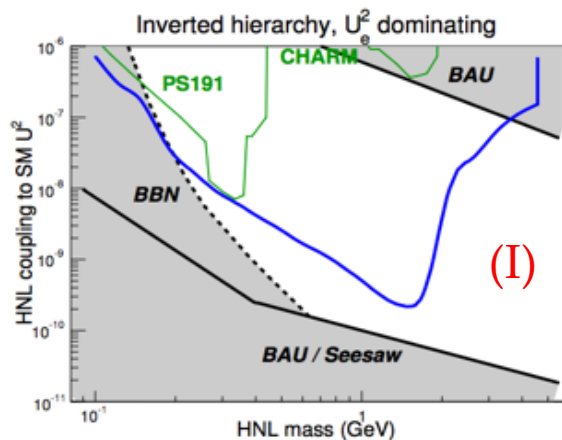
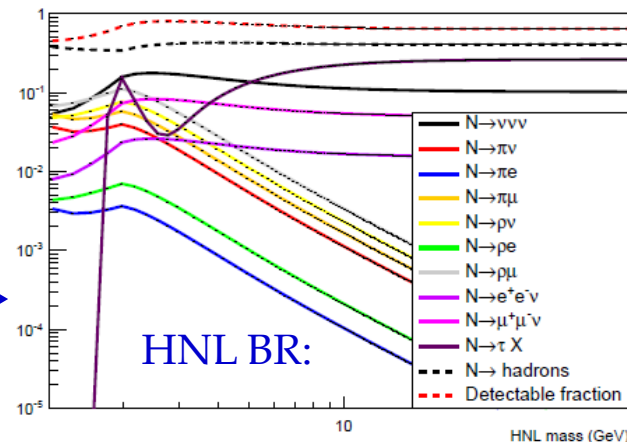

For $M_N = 1$ GeV:

U_μ^2	τ_N	$\mu\pi$ events
10^{-7}	1.8×10^{-5} s	12000
10^{-8}	1.8×10^{-4} s	120
10^{-9}	1.8×10^{-3} s	1

Assuming a level of background of 0.1 ev., curves can be interpreted as 3σ evidence

- I $U_e^2 : U_\mu^2 : U_\tau^2 \approx 52 : 1 : 1$, inverted hierarchy
- II $U_e^2 : U_\mu^2 : U_\tau^2 \approx 1 : 16 : 3.8$, normal hierarchy
- III $U_e^2 : U_\mu^2 : U_\tau^2 \approx 0.061 : 1 : 4.3$, normal hierarchy

❖ Ultimate see-saw limit is almost in reach \rightarrow still would require increase of the SPS intensity by an order of magnitude (does not currently seem to be realistic)

Neutrino Portal: HNL Sensitivities in Collider Experiments

SHIP complementarity: Colliders are not very sensitive with low mass / long lifetimes:

- BELLE-2 using $B \rightarrow X l N$, where $N \rightarrow l \pi$ may go well below 10^{-4} in $0.5 < M_N < 5$ GeV
- TLEP using $Z \rightarrow N \nu$ with $N \rightarrow \text{lepton} + 2 \text{ jets}$

Summary of past searches for HNL:

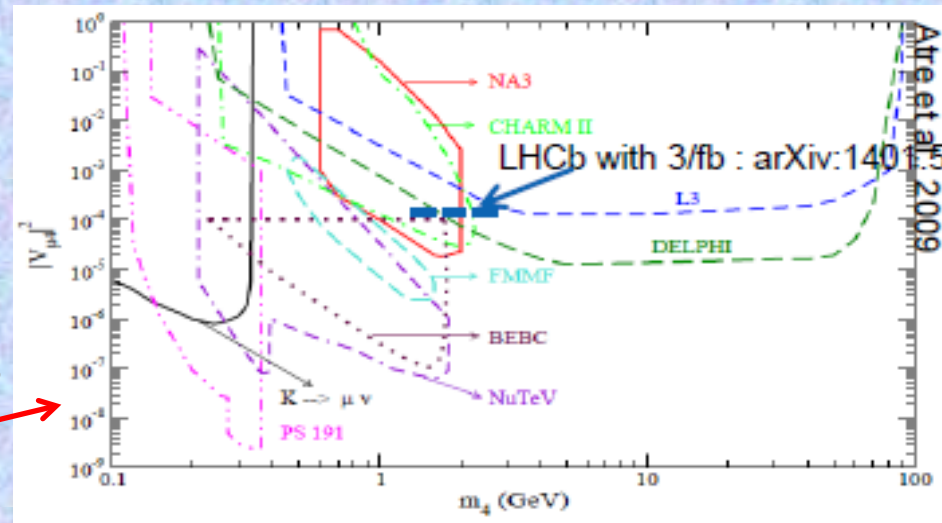

Depends on HNL decay length and efficiency:

❖ $W \rightarrow \ell N$ at LHC: extremely large BG, difficult triggering/analysis.

❖ $Z \rightarrow N \nu$ at e+e- collider: clean (expected sensitivity of FCC in e+e- mode assuming zero bkg.)

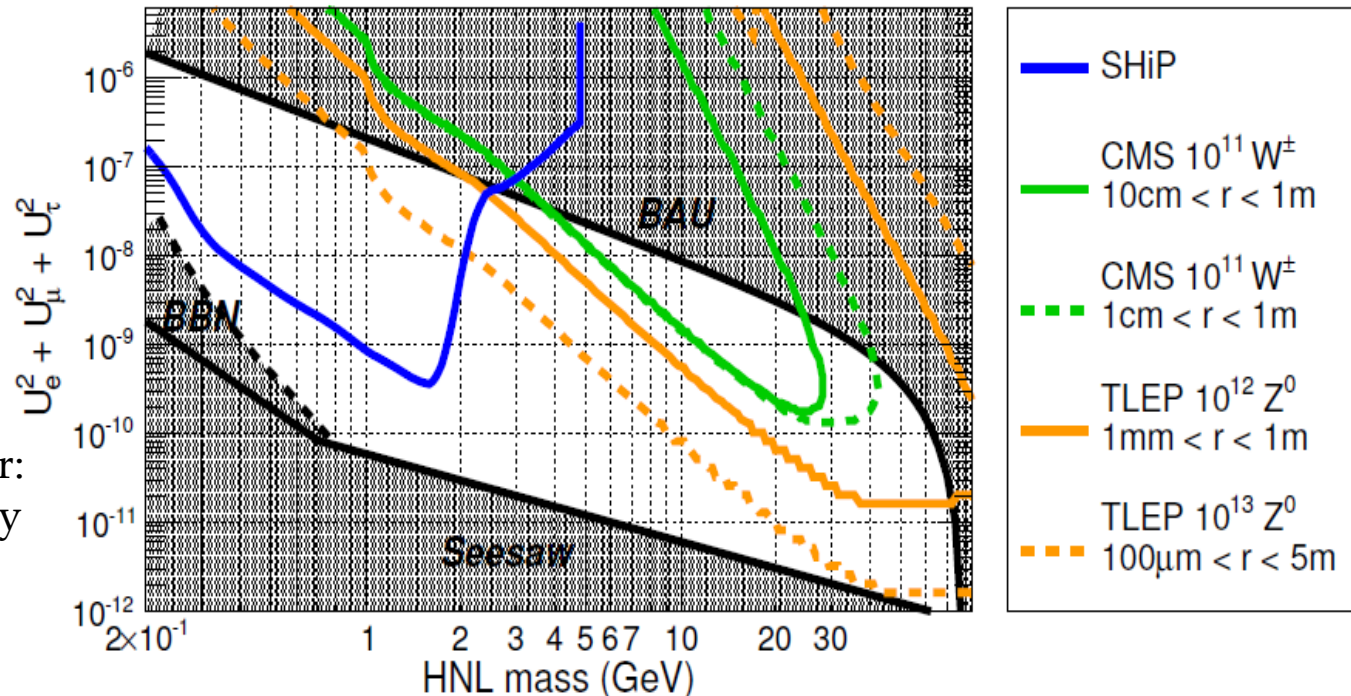

Minimal Vector Portal: Sensitivity to Dark Photons

Dark photon production at SPS:

- γ' - bremsstrahlung off the incoming proton beam
- Meson decays ($\pi^0, \eta, \omega, \eta', \dots$): $\pi^0 \rightarrow \gamma' \gamma$

PLB731 (2014) 320
arXiv:1311.0029

Dark photon decays: $e+e-, \mu+\mu-, qq (\pi+\pi-, \dots)$...

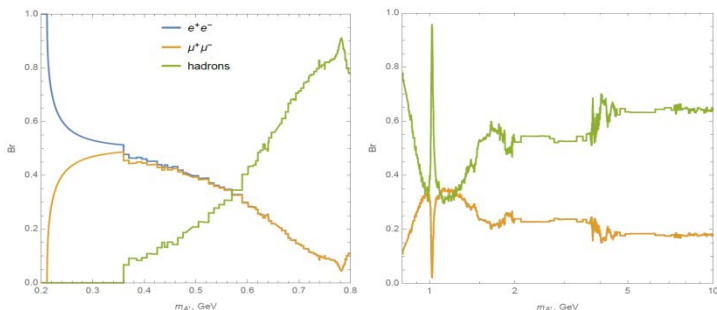

Includes $e+e-, \mu+\mu-$ and hadronic final states:

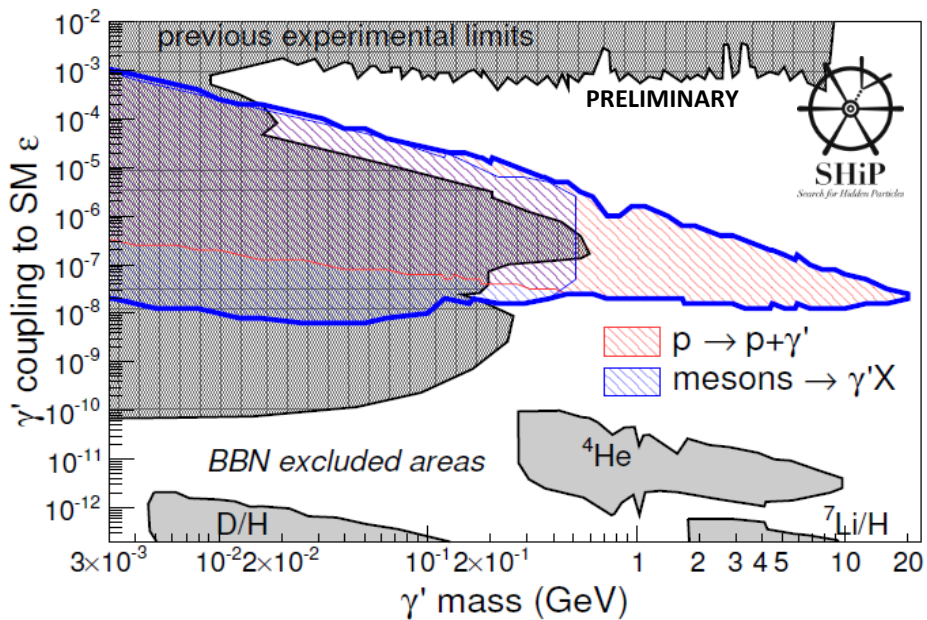

Includes form factor suppression to take possibly into account parton scattering

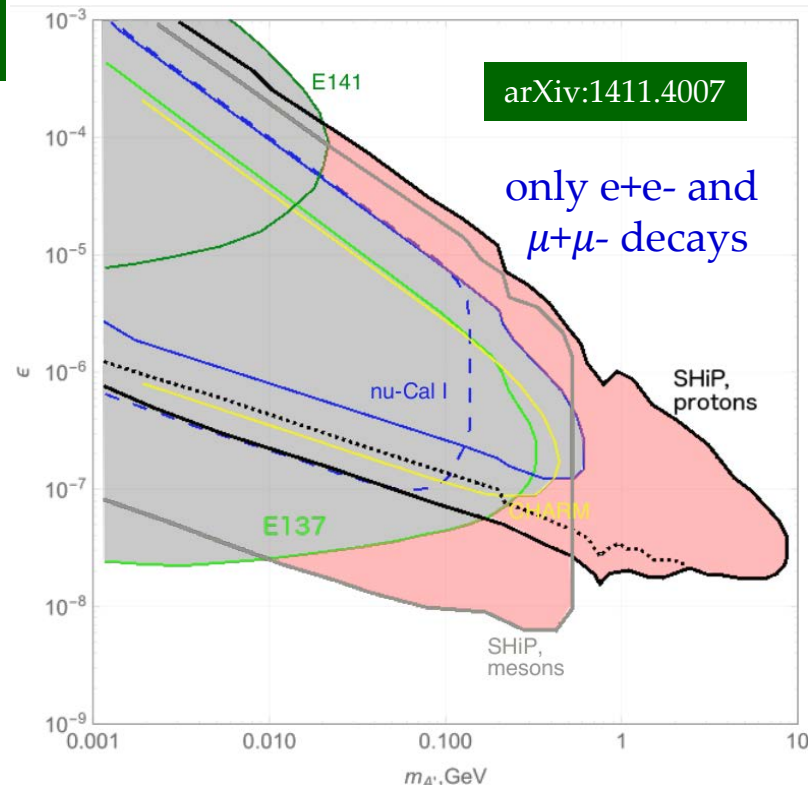

Sensitivity can be improved by SHiP:

hadronic fixed target experiments overcome the kinematic limitation of e-fixed target, allowing searches for $m(\gamma') > 1\text{GeV}$

Higgs Portal: Sensitivity to Dark Scalars

SM Higgs + real singlet scalar (ϕ or h):

- Could have mass $m_h < 5$ GeV;
- Mixing with the SM Higgs with angle ρ :

Dark Scalar Production:

arXiv: 1310.6752
arXiv: 1310.8042

- direct: $p + \text{target} \rightarrow hX$
 - flavour decays: $B \rightarrow hK^*$ (this study)
- (D-CKM suppressed wrt B (5×10^{-10}), while $\sigma(D)$ only 20k times larger $\sigma(B)$ at 27GeV)



Dark Scalar Decays:

some uncertainty in the calculation of BR(h):

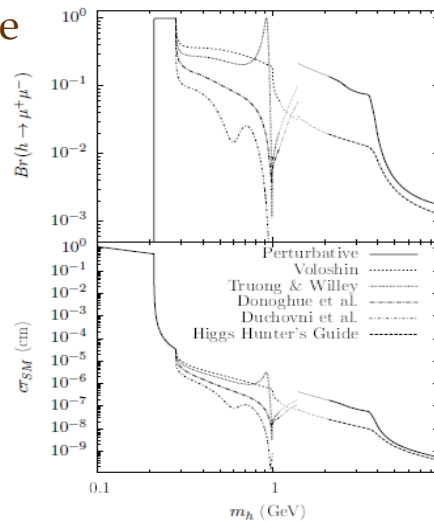
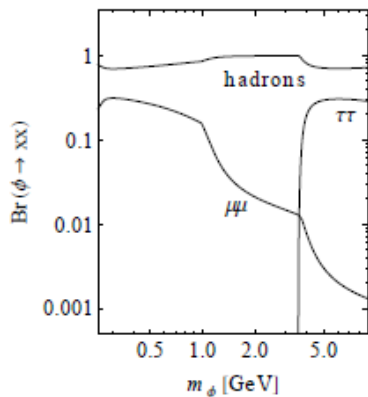

Dark scalar: $h \rightarrow \mu^+ \mu^-$

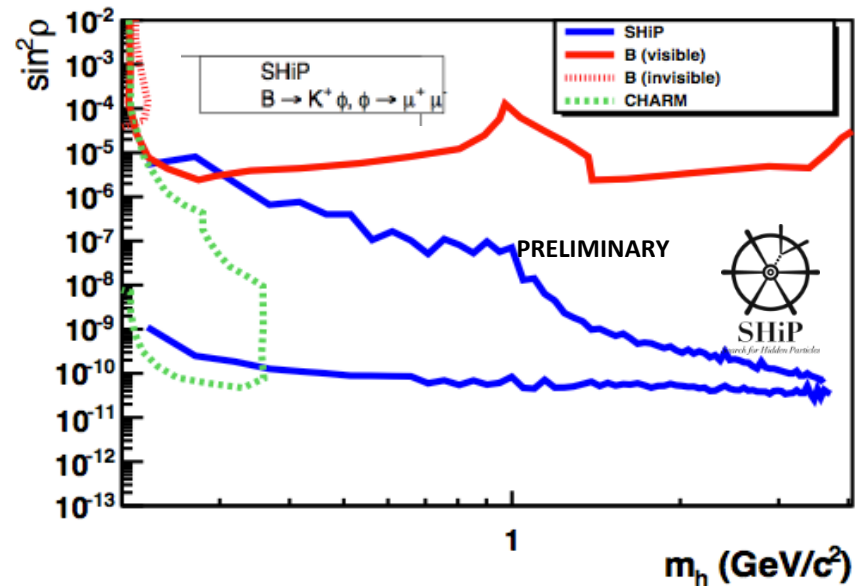

Sensitivity can be improved by SHiP:

Current sensitivity includes only B decays and only muon final states (need to add hadronic channels), cross section a bit conservative (/3)

Axion Portal: Sensitivity to Pseudo-Scalars, Axion-Like Particles

ALPs are well motivated from theory
 → typically pseudo-Goldstone bosons

❖ ALP Coupling to two photons:

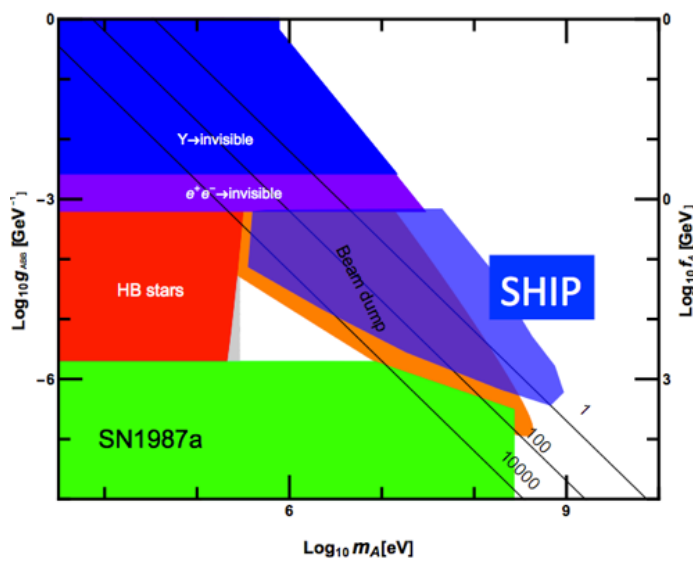
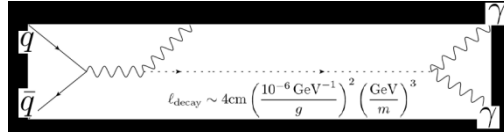

PNGB:
 decays
 to $\gamma\gamma$

SHIP can improve limits / can discover:

- ❖ Significant gain for fermion couplings
- ❖ Some gain for two-photon coupling
- ❖ Study of two-gluon coupling still to be done

❖ ALP Coupling to fermions:

- Production via ALP-pion mixing;
- ALP decays to $\gamma\gamma, \mu\mu, ee$

Probe high energy scales:

Interpretation of
 CHARM as
 production
 from neutral
 pion mixing !

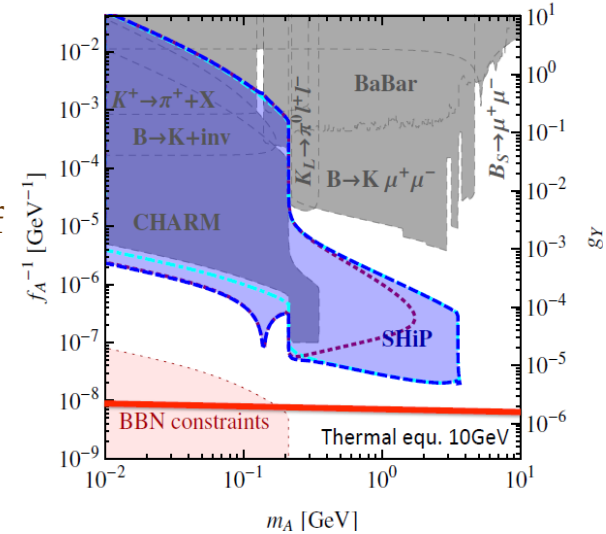

PNGB:
 e^+e^- & $\mu^+\mu^-$

beyond 1GeV
 things are
 complicated
 due to
 dominance of
 hadronic decays

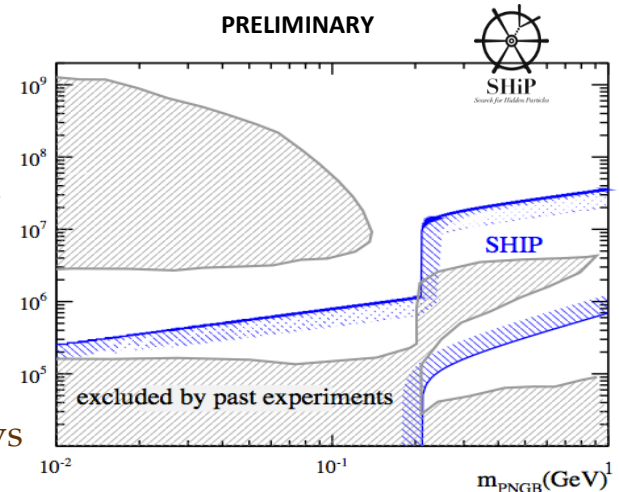

SHIP Physics Program: Direct SUSY Detection

➤ Light SUSY sgoldstinos (hep-ph/000735):

Production/decay might be like HNL, i.e. $D \rightarrow \pi X$ followed by $X \rightarrow \pi + \pi^-$

➤ Light R-parity violating SUSY neutralinos (hep-ph/0106199):

$B/D \rightarrow X\chi_0$, $\chi_0 \rightarrow \mu + \mu - \nu$; $\chi_0 \rightarrow K\nu$; $K + e^-$
LSP with R-parity "slightly" violated: $\tau < 0.1$ s

➤ Light Pseudo-Dirac Gauginos:
predicted in SUSY with U(1) R-symmetry
 $pp \rightarrow \Psi\Psi$; $\chi_2 \rightarrow ll \chi_1$

➤ Chern-Simons portal:
new X vector boson coupled to SM bosons with Chern-Simons like interactions

Light Pseudo-Dirac Gauginos:

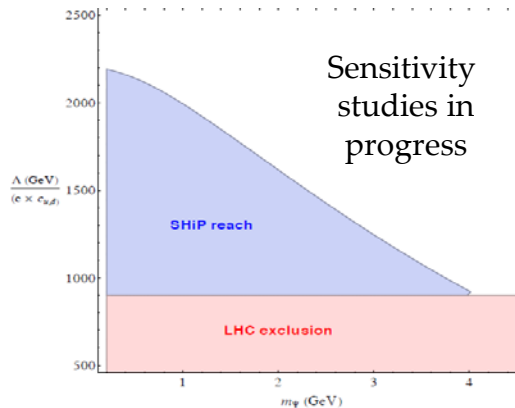

RPV neutralinos:

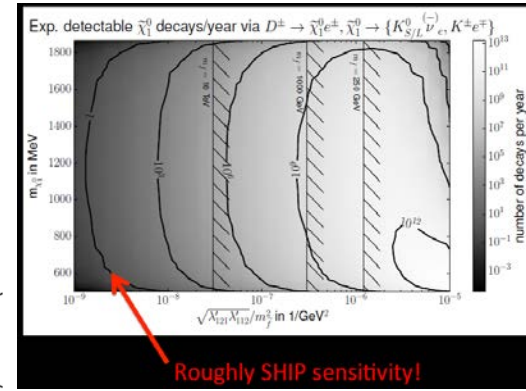
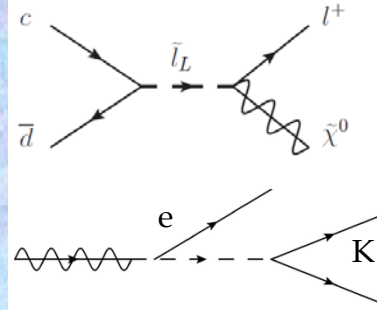

add B-decays to extend mass reach

Chern-Simons portal:

$D \rightarrow W^* \rightarrow W^* X$

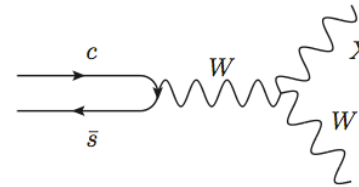

Decay controlled by c_Z

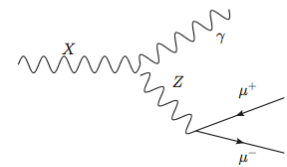

- $X \rightarrow \ell^+ \ell^- \gamma$
- $X \rightarrow q\bar{q}\gamma \rightarrow \gamma + \pi^0$
- $X \rightarrow q\bar{q}\gamma \rightarrow \gamma + \text{mesons}$

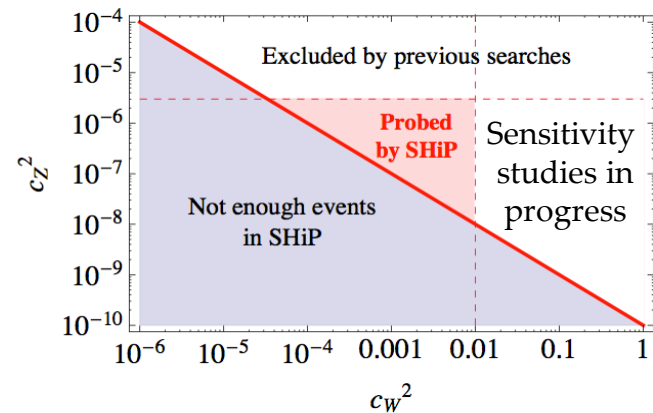

SHIP Physics Program: SUSY Hidden Sector

SUSY Hidden Sector:

Gauge extension:
SU₃xSU₂xU₁xU₁

Modified decays
of hidden photon:

- Physical states:
 - 1 A' massive hidden photon
 - 3 $\chi_{1,2,3}^x$ hidden fermion "neutralinos" (lightest is stable)
 - 2 $h_{1,2}^x$ hidden scalar Higgs bosons
 - 1 a^x hidden pseudoscalar Higgs boson

arXiv: 1402.4817

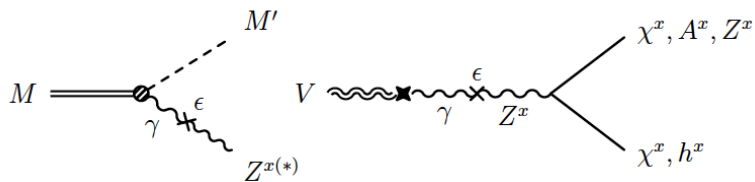

Experimental Signals of the Theory

- Depend mainly on how the hidden photon decays. This is determined mostly by the mass spectrum.
- Four main cases:
 - A: $A' \rightarrow SM + SM$, similar to minimal vector portal
 - B: $A' \rightarrow \chi_1^x + \chi_1^x$, similar to dark vector portal
 - C: $A' \rightarrow h_1^x + a^x$, not much attention [Schuster, Toro, Yavin 2009]
 - D: $A' \rightarrow \chi_1^x + \chi_2^x$, new!

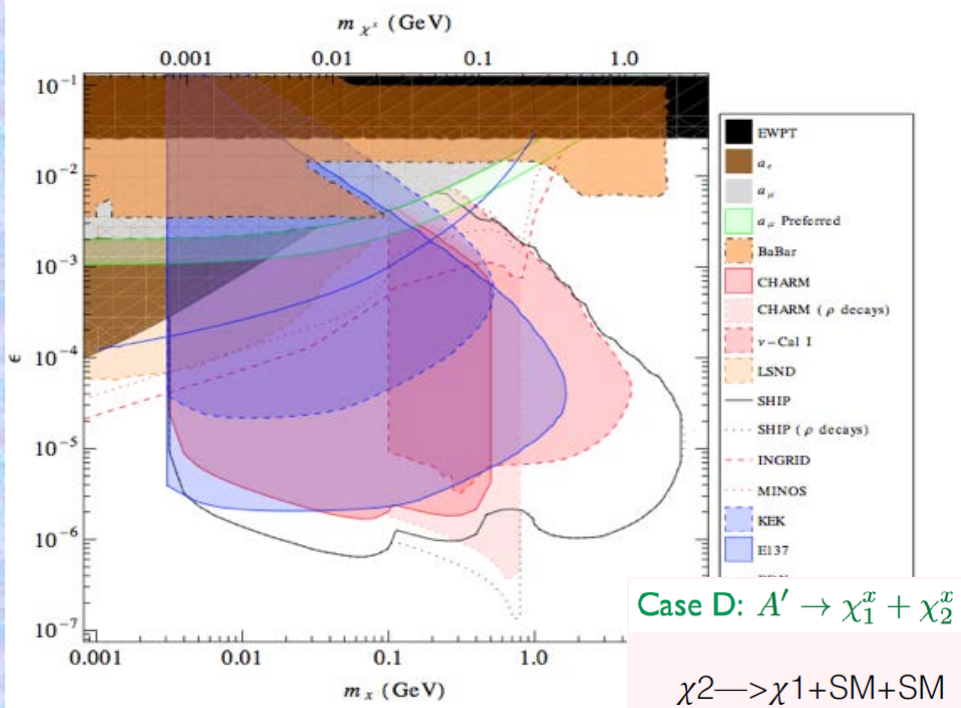
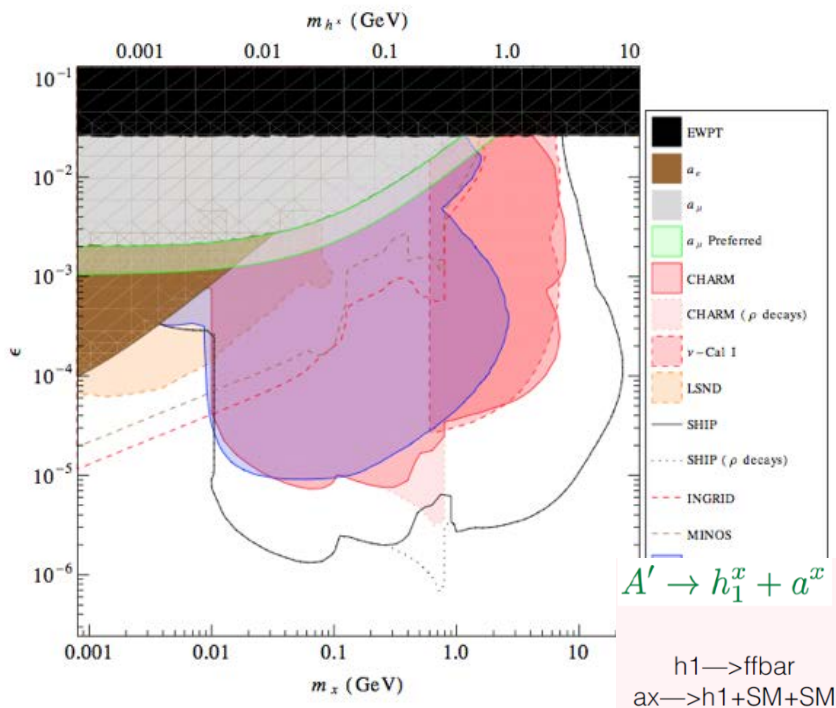

Extension of SHIP Facility: Direct Dark Matter Search

Relativistic beam of light Dark Matter with 2×10^{20} pot

❖ The signature of DM is a neutral current scattering event \rightarrow very similar to ν -induced NC event

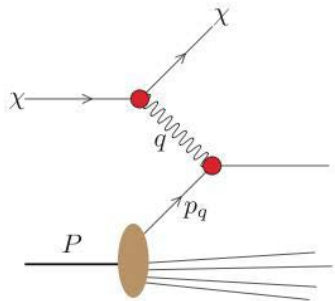

Tau neutrino detector could be used for DM detection (9 ton) \rightarrow comparison with E613 FNAL \rightarrow factor 100 more events in SHIP (but also more background (neutrino NC))

Production of the Dark Matter beam

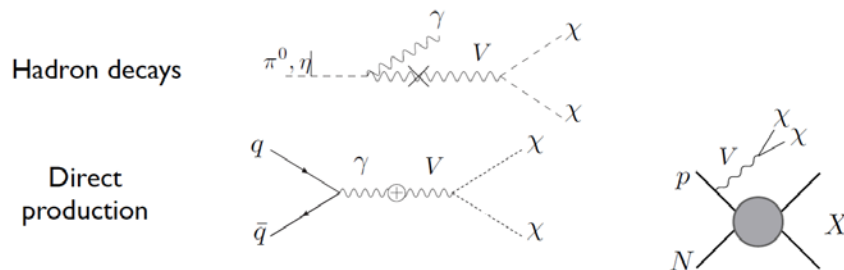

Detection via scattering - anomalous neutral currents

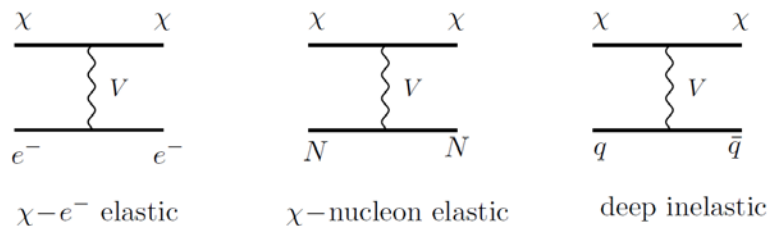

Tau neutrino detector is 9t for DM \rightarrow a factor 10 less mass

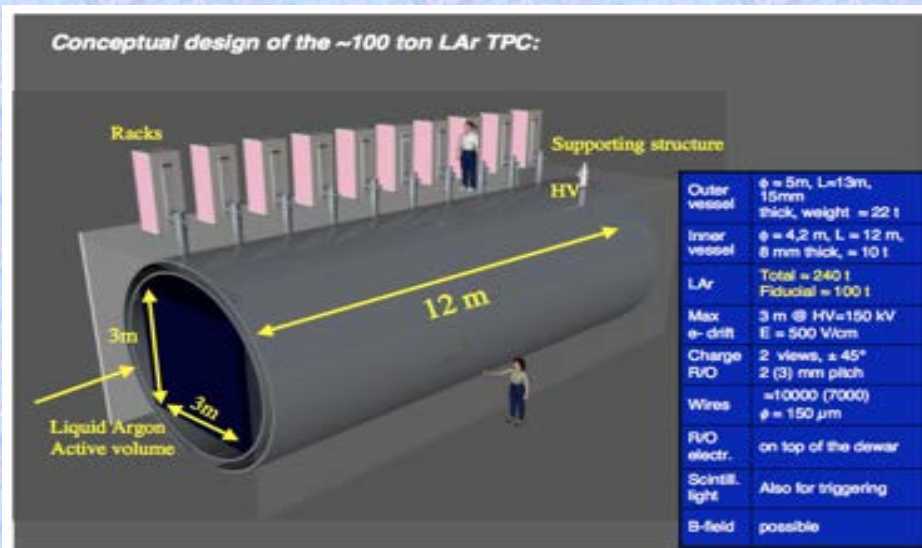
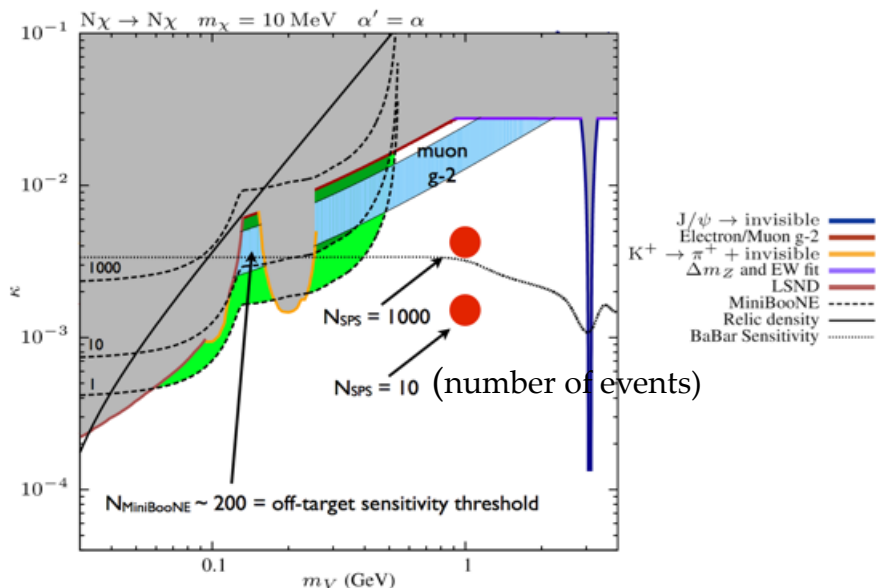

Extension of SHIP Facility: LFV $\tau \rightarrow 3\mu$ Searches

Collider Experiments: LFV Searches $\tau \rightarrow \mu^+\mu^-\mu^-$ (LHCb)

Observed (expected) $\tau \rightarrow \mu^+\mu^-\mu^-$: 8.0×10^{-8} (8.3×10^{-8})
 v-mass

term (SM)

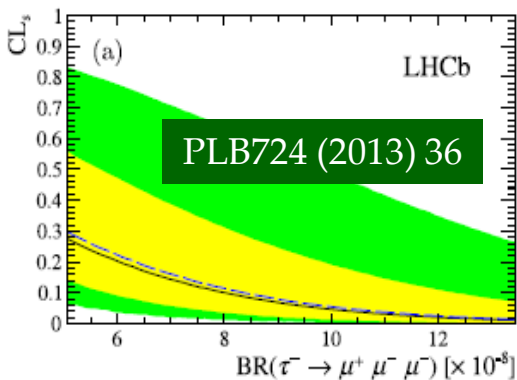
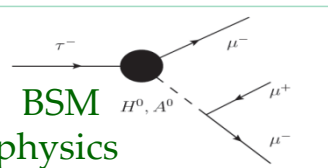
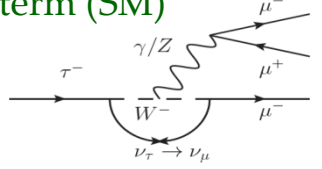

Sensitivity:

1 fb⁻¹ (LHCb)



1 ab⁻¹ (e+e-, charm/tau factory)

LHCb Run 2 may overtake the Belle limit ...
 but should eventually be overtaken by Belle 2

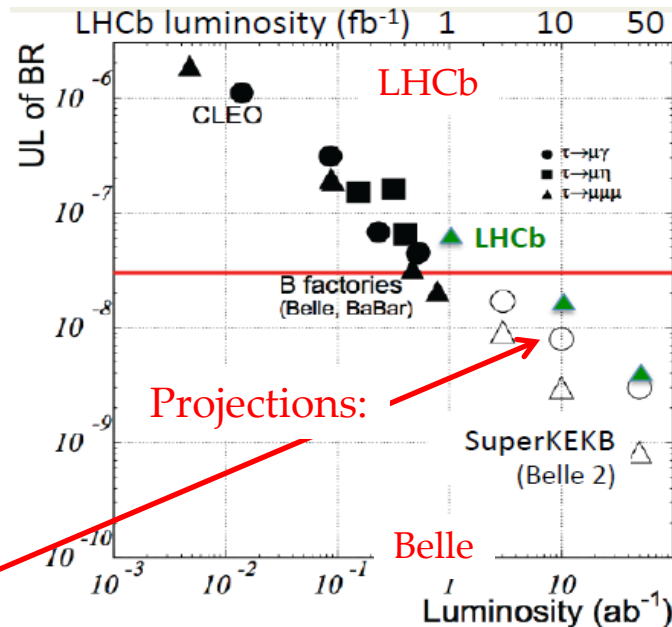

SHIP Experimental Facility:

- use 1 mm heavy material (W) target

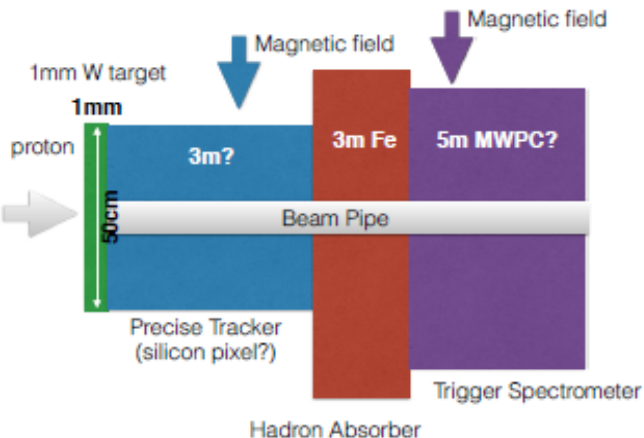

List of D-backgrounds:

Decay	\mathcal{B}
$D^+ \rightarrow \eta \mu^+ \nu_\mu$	$1.14 \cdot 10^{-3}$
$\eta \rightarrow \mu^+ \mu^-$	$5.8 \cdot 10^{-6}$
or	
$\eta \rightarrow \mu^+ \mu^- \gamma$	$3.1 \cdot 10^{-4}$
$D^+ \rightarrow \rho \mu^+ \nu_\mu$	$2.4 \cdot 10^{-3}$
$\rho \rightarrow \mu^+ \mu^-$	$4.55 \cdot 10^{-5}$
$D^+ \rightarrow \eta' \mu^+ \nu_\mu$	$2.2 \cdot 10^{-4}$
$\eta' \rightarrow \mu^+ \mu^- \gamma$	$1.8 \cdot 10^{-4}$
$D^+ \rightarrow \omega \mu^+ \nu_\mu$	$1.6 \cdot 10^{-3}$
$\omega \rightarrow \mu^+ \mu^-$	$9.0 \cdot 10^{-5}$
$D_s^+ \rightarrow \eta \mu^+ \nu_\mu$	$2.7 \cdot 10^{-2}$
$\eta \rightarrow \mu^+ \mu^-$	$5.8 \cdot 10^{-6}$
or	
$\eta \rightarrow \mu^+ \mu^- \gamma$	$3.1 \cdot 10^{-4}$
$D_s^+ \rightarrow \eta' \mu^+ \nu_\mu$	$9.9 \cdot 10^{-3}$
$\eta' \rightarrow \mu^+ \mu^- \gamma$	$1.8 \cdot 10^{-4}$

- the main handle:
 - decay vertex separation from the target
 - improving spatial/time resolution
- to be studied additionally
- imposes tight requirements on the trigger!

Sensitivity studies
 are in progress

SHIP Experiment Progress in 1 Year

- SHIP is the universal tool to probe New Physics at the Intensity Frontier in the largely unexplored domain of new, very weakly interacting particles
- SHIP facility also opens unique opportunity for $\nu\tau$ - physics (largely extending original physics motivation of the SHIP proposal to the SM Physics)
- Future extension of the SHIP facility for DM and LFV searches is possible
- Major technological and engineering challenges of the SHIP Facility have been addressed during the last year:
 - target and beam-line active muon shield (thanks to CERN EN), decay volume, background taggers, timing detectors ...

One year ago SHIP was just an idea

→ TODAY SHIP IS THE GENERAL PURPOSE FACILITY which could help:

- to increase diversity of the particle physics program world-wide
- to explore the Fermi scale and to provide guidance on the scale of the New Physics or on the coupling strength of any new particles to the SM particles.