

Colloque de l'Orme des Merisiers
CEA Saclay
5/18/10

Laser Electron Acceleration and the Next Step

Toshi Tajima
Blaise Pascal Chair,
Fondation Ecole Normale Supérieure
Institut de Lumière Extrême
and
LMU, MPQ, Garching

Acknowledgments for Advice and Collaboration: G. Mourou, V. Malka, J. Fuchs, C. Labaune, H. Videaux, P. Mora, F. Krausz, D. Habs, S. Karsch, L. Veisz, F. Gruener, T. Esirkepov, M. Kando, K. Nakajima, A. Chao, A. Suzuki, F. Takasaki, S. Bulanov, P. Bolton, A. Giullietti, W. Leemans, T. Raubenheimer, A. Ogata, A. Caldwell, P. Chen, Y. Kato, M. Downer, M. Tigner, H.C. Wu, K. Kondo, S. Kawanishi, M. Hegelich, P. Shukla, S. Chattopadhyay, K. Yokoya, S. Cheshkov, D. Normand, M. Teshima, M. Nozaki, J. Chambaret, A. Galvanauskas, N. Hafz, J. Koga, N. Toge

Livingston Chart and Recent Saturation

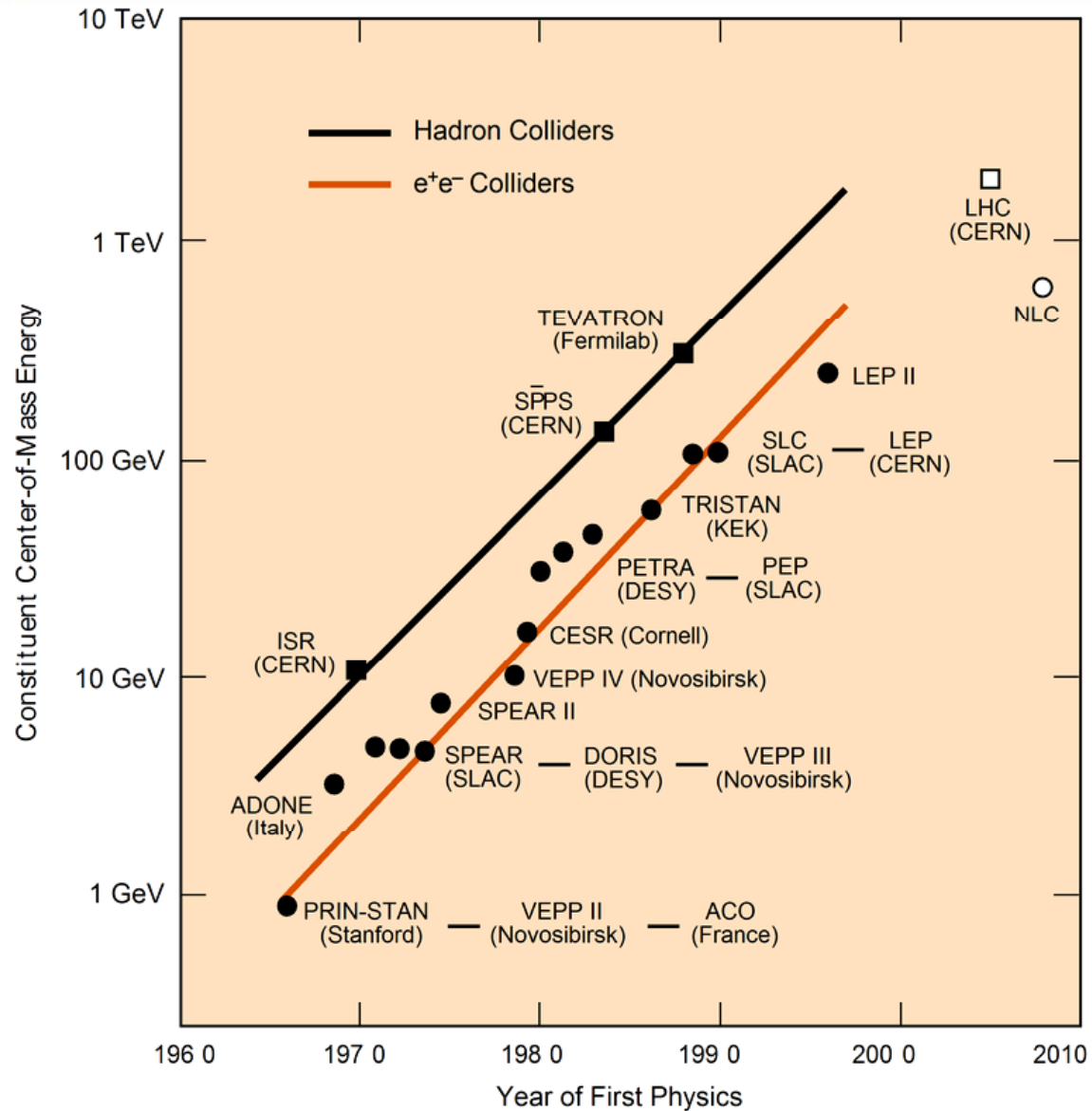
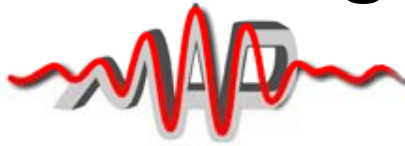

(Suzuki, 02 03)

Demise of SSC (Super collider)



Terminated Texas tunnel. The SSC was abandoned after about 25% of the tunnel for the 87-kilometer-circumference large collider ring had been bored.

By largest machine to probe smallest of structure of matter

size	10 ² km
energy	20TeV
cost	\$10B

US:

Texas site decided (1989)

US Government decided to terminate its work: 1993

Tajima: 'Tamura Symposium' on the Future of Accelerator Physics @ UT Austin
(1995)

Can laser help accelerators?

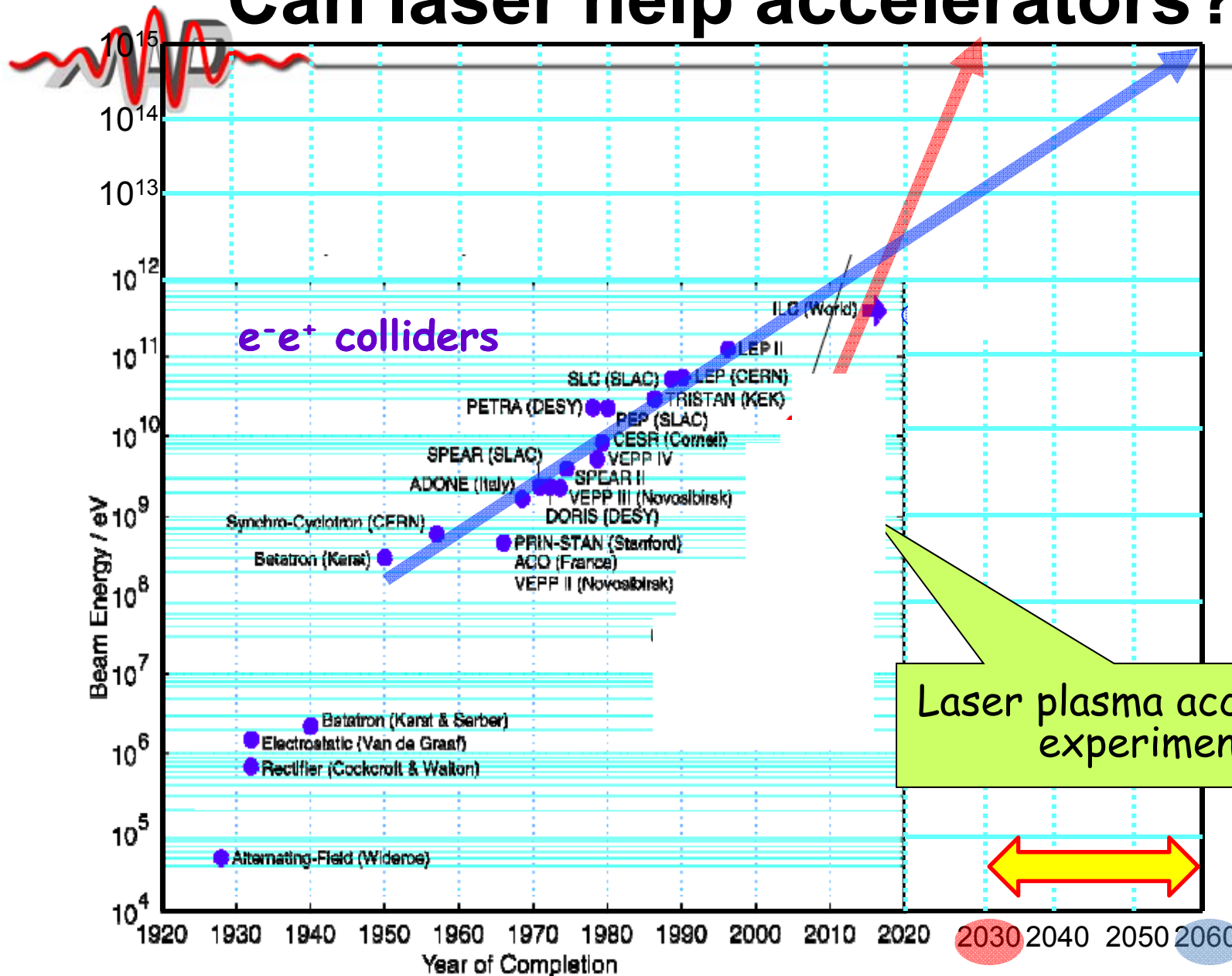

(Suzuki, 2009)

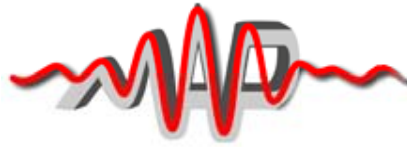

What is collective force ?

How can a Pyramid have been built?

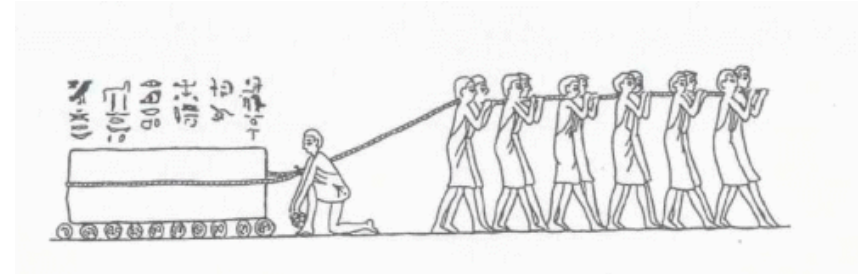

Individual particle dynamics → Coherent and collective movement

Collective acceleration (Veksler, 1956; Tajima & Dawson, 1979)

Collective radiation (N^2 radiation)

Collective ionization (N^2 ionization; Ogata, 2006)

Collective deceleration (Tajima & Chao, 2008 ; Ogata, 2009)

Plasma lens (Chen, 1987; Toncian et al. 2006)

Wakefield: a Collective Phenomenon



All particles in the medium participate = collective phenomenon

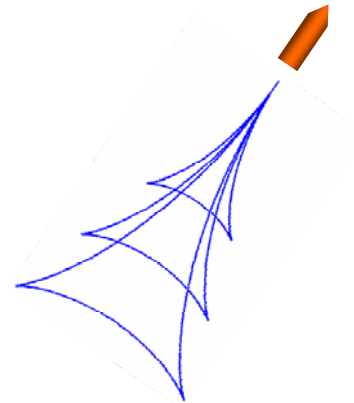

Kelvin wake

$$\omega = \sqrt{kg}$$

$$x = X_1 \cos \theta \left(1 - \frac{1}{2} \cos^2 \theta \right)$$

$$y = X_1 \cos^2 \theta \sin \theta$$

$$-\pi/2 < \theta < \pi/2$$

No wave breaks and wake **peaks** at $v \approx c$

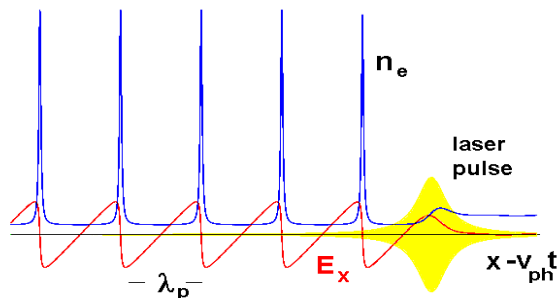

$$\lambda_p = 2\pi / k_p \quad k_p v_{ph} = \omega_{pe}$$

$$\omega_{pe} = \left(4\pi n e^2 / m_e \right)^{1/2} \quad \text{(The density cusps. Cusp singularity)}$$

Wave **breaks** at $v < c$



Laser Acceleration of Electrons



Gradient limit : breakdown threshold for microwave ($< 100\text{MeV/m}$)

E. Lawrence: cyclotron (c. 1932)

SSC: 10^2 km circumference (\dagger 1993); Linear Collider: $> 10\text{km}$ ($\sim 2020?$)

Plasma : already ‘broken’ matter. No breakdown threshold.

‘collective ion acceleration’ (Veksler, 1956): ion trapping difficult ($v_{tr,ion} \ll c$)

Introduction of laser acceleration (Tajima and Dawson, 1979)

Linear EM field: cannot accelerate: *Woodward-Lawson Theorem*

Strong nonlinear fields

longitudinal acceleration (rectification of laser fields; $v \times B/c \sim O(E)$)

laser plays master, plasma slaves----- provides hard structure

electron trapping possible (revisit of ion acceleration now) ($v_{tr,e} \sim c$)

→ High Field Science

Ultrafast pulses

fs regime: ions immobile; enhanced with collective electron resonance

absence of ‘notorious’ hydrodynamical plasma instabilities; controllability;

relatively small laser energy (e.g. ELI)

Large gradient ($> 10\text{GeV/m}$, leap by > 3 orders of magnitude)

Low emittance ($< \text{mm mrad}$ regime)

Thousand-fold Compactification

Laser wakefield: thousand folds gradient (and emittance reduction?)

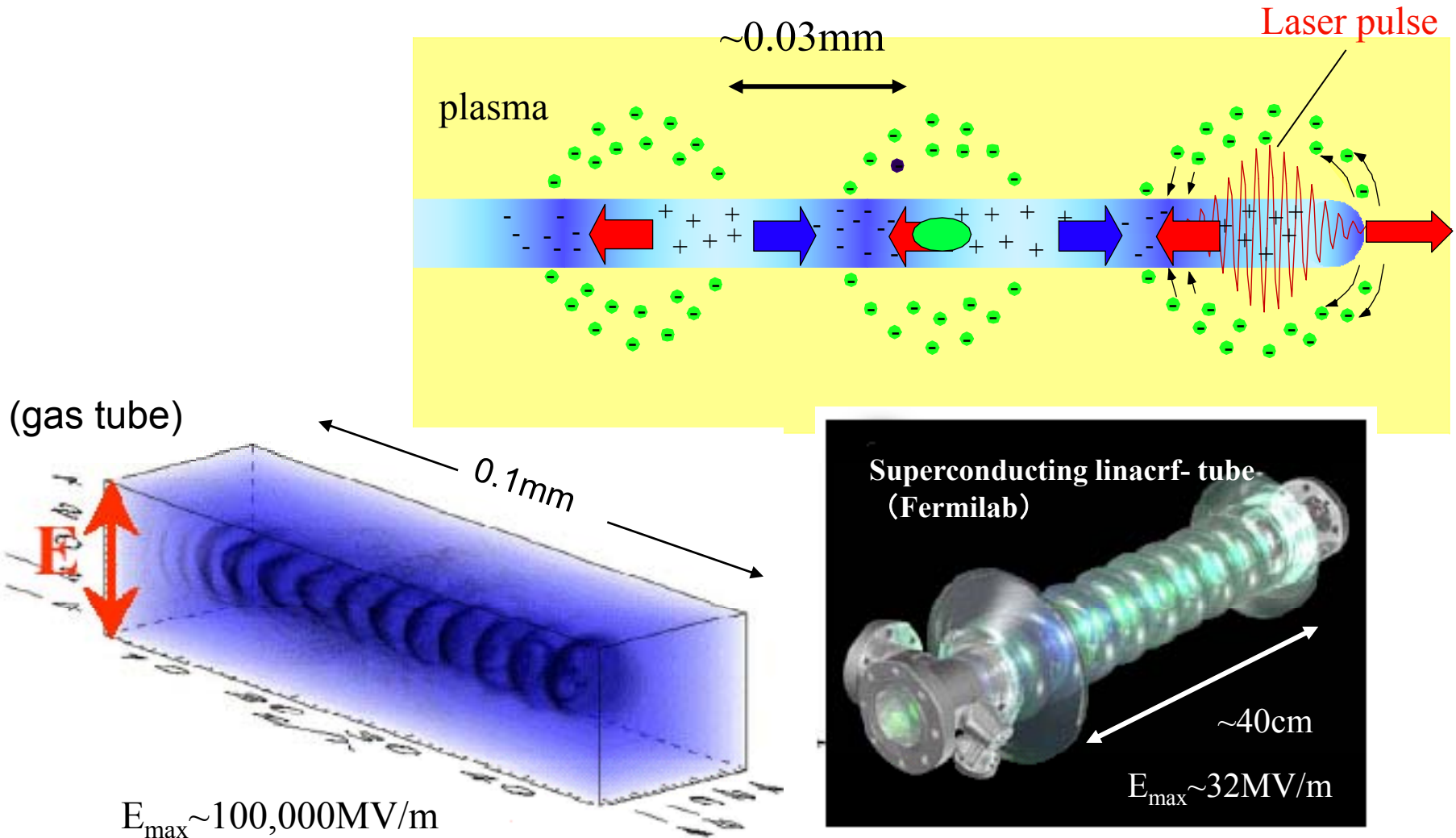

GeV electrons from a centimeter accelerator

(a slide given by S. Karsch)

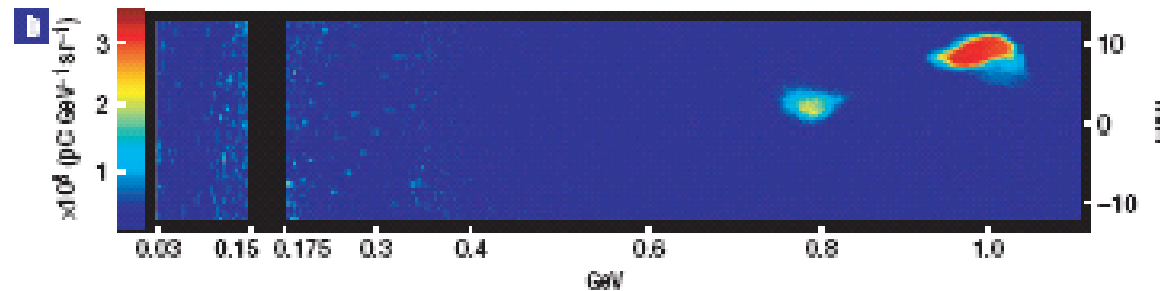
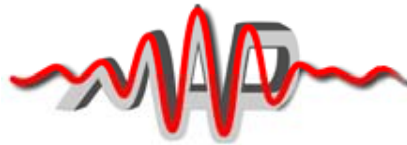

310- μm -diameter
channel capillary

$P = 40 \text{ TW}$

density $4.3 \times 10^{18} \text{ cm}^{-3}$.

Leemans et al., Nature Physics, september 2006

Laser Electron Accelerator

T. Tajima and J. M. Dawson

Department of Physics, University of California, Los Angeles, California 90024

(Received 9 March 1979)

An intense electromagnetic pulse can create a weak of plasma oscillations through the action of the nonlinear ponderomotive force. Electrons trapped in the wake can be accelerated to high energy. Existing glass lasers of power density 10^{18} W/cm^2 shone on plasmas of densities 10^{18} cm^{-3} can yield gigaelectronvolts of electron energy per centimeter of acceleration distance. This acceleration mechanism is demonstrated through computer simulation. Applications to accelerators and pulsers are examined.

1 GeV capillary accelerator experiment at LBNL/Oxford U.

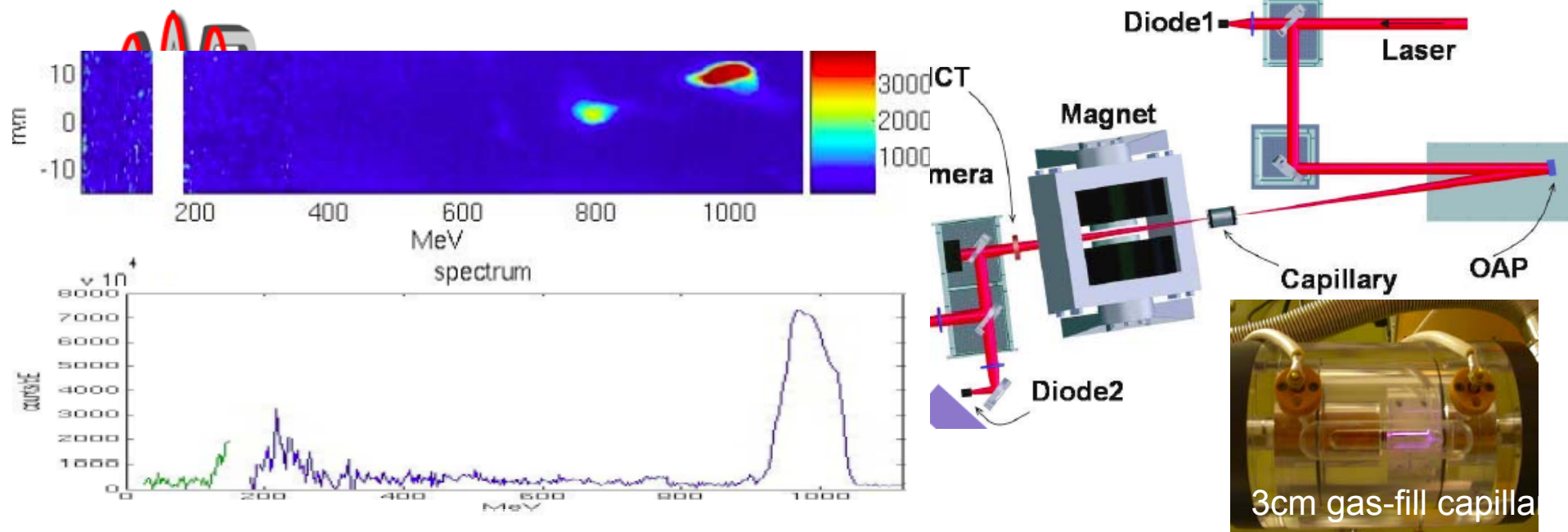

0.56 GeV capillary accelerator experiment at CAEP/KEK

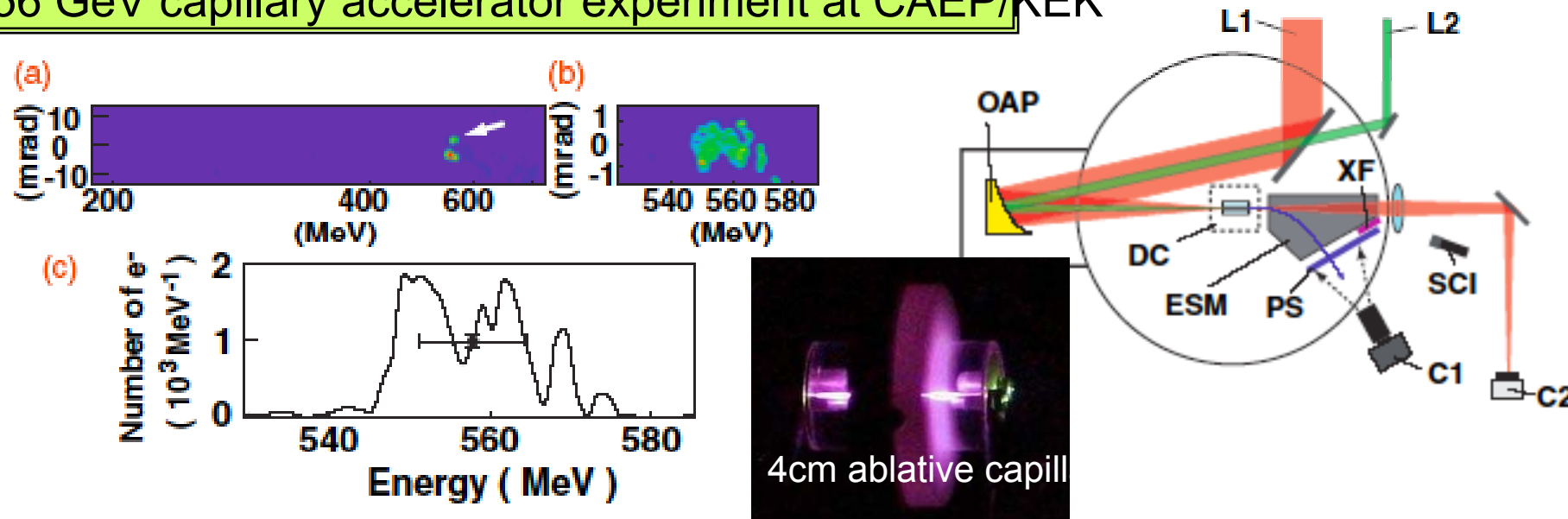

Stable electron beams and more high-energies from 1 cm gas jet at GIST, Korea

100TW laser system at Gwangju Institute of Science and Technology



Mean electron energy = 236.9 MeV
 SD/Mean E = 5 %
 Charge: ~100pC
 Divergence angle: ~a few mrad

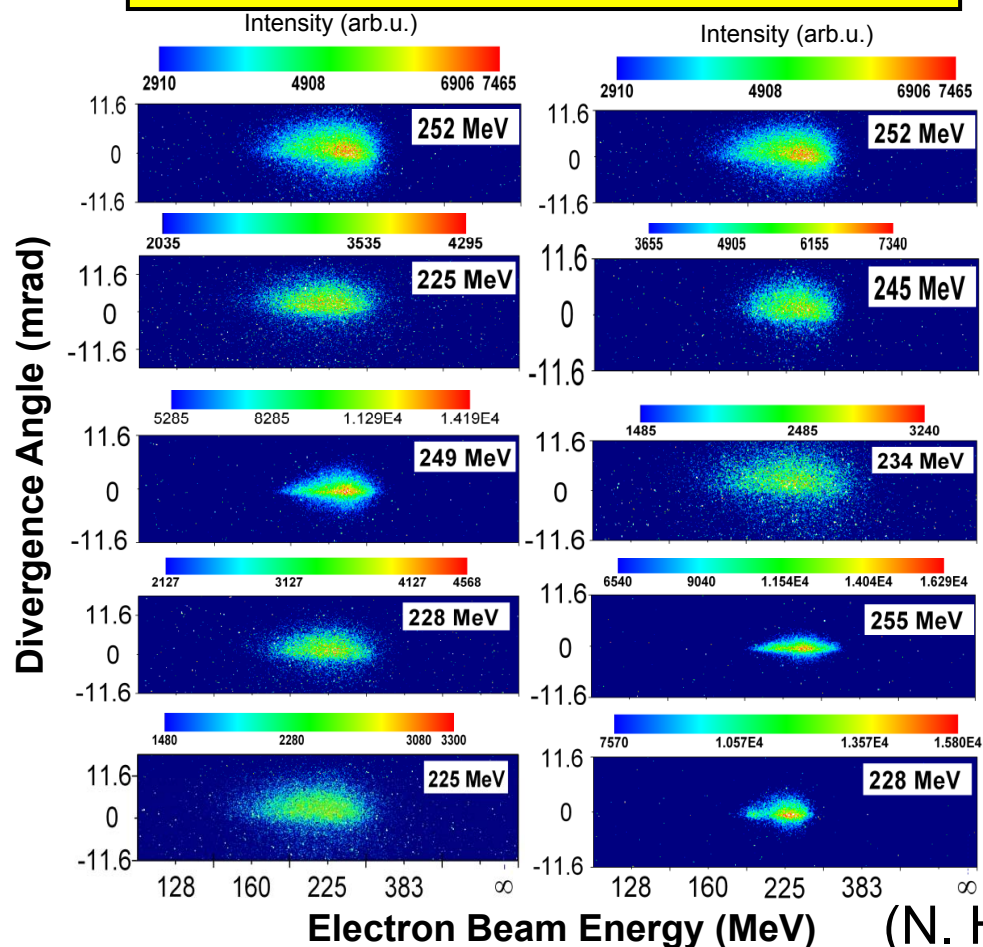

Recent results at 50 TW

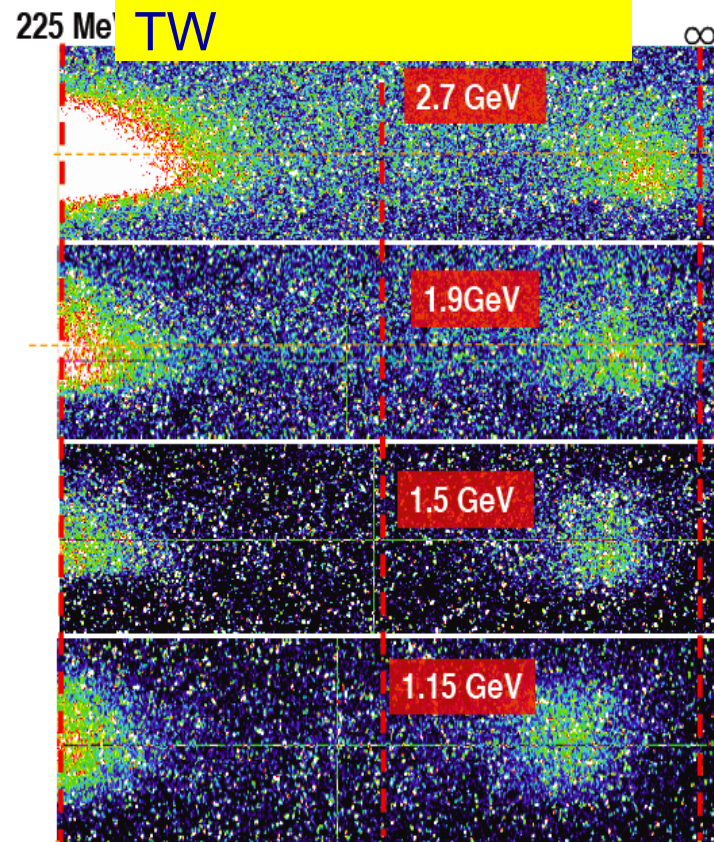

(N. Hafz et al., Nature Photon., 2, 571, 2008)

3D Wave-Breaking / Bubble Effects

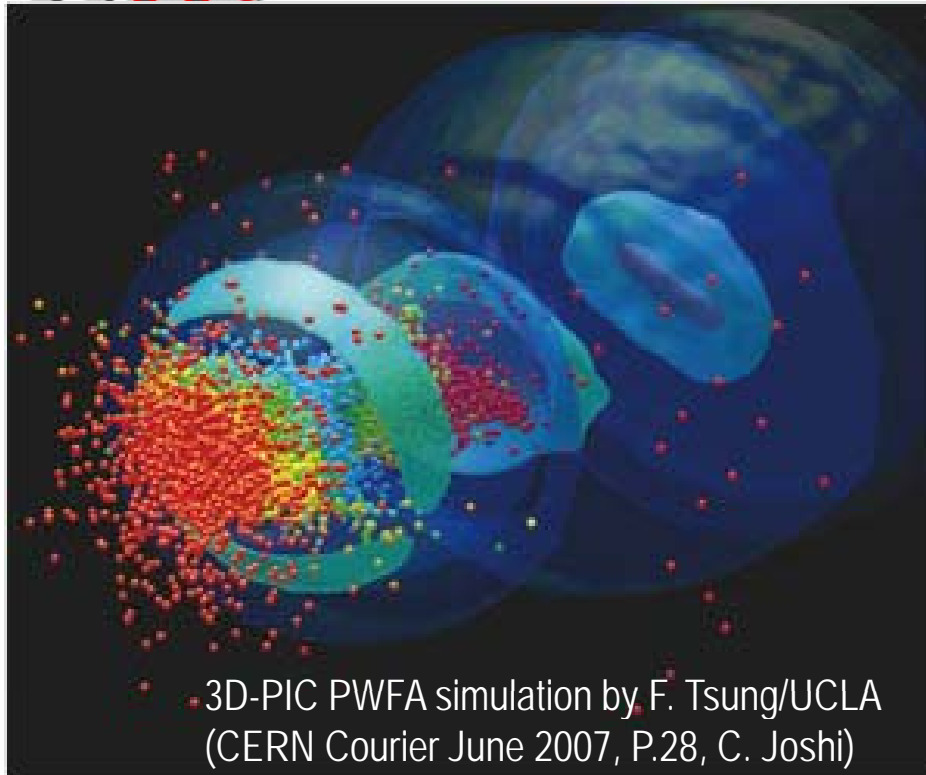

← Particle Driven Plasma Acceleration

Laser Driven Plasma Acceleration

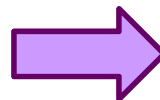

(Suzuki)

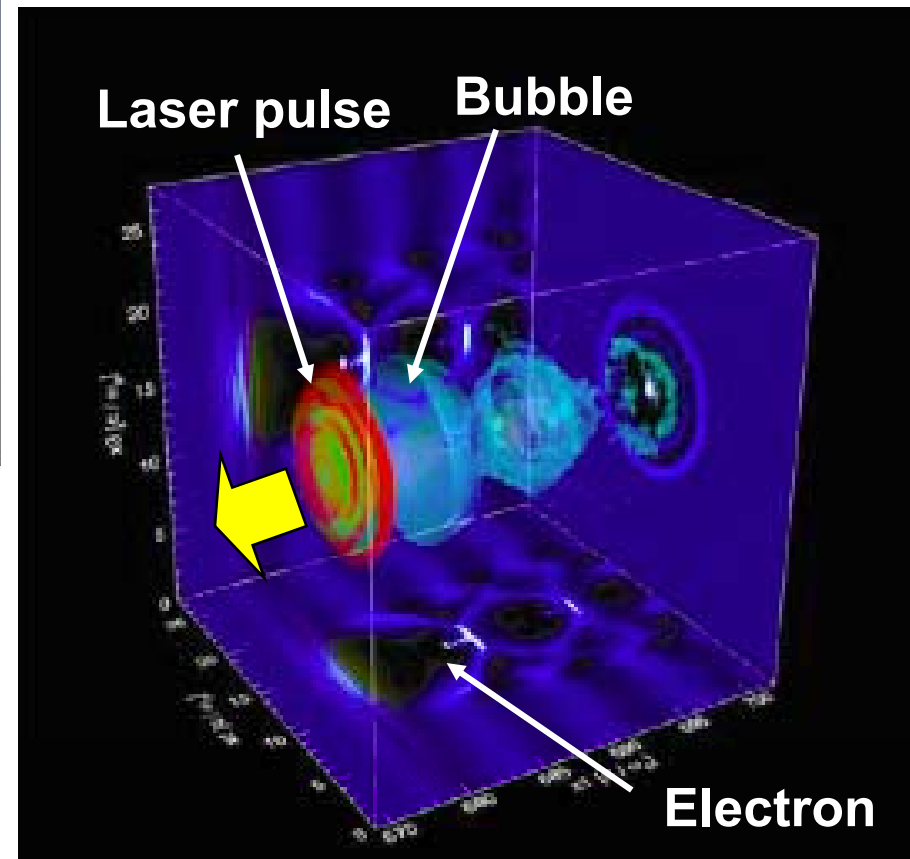

Wakefield in Stable 1D Regime



(J. Koga)

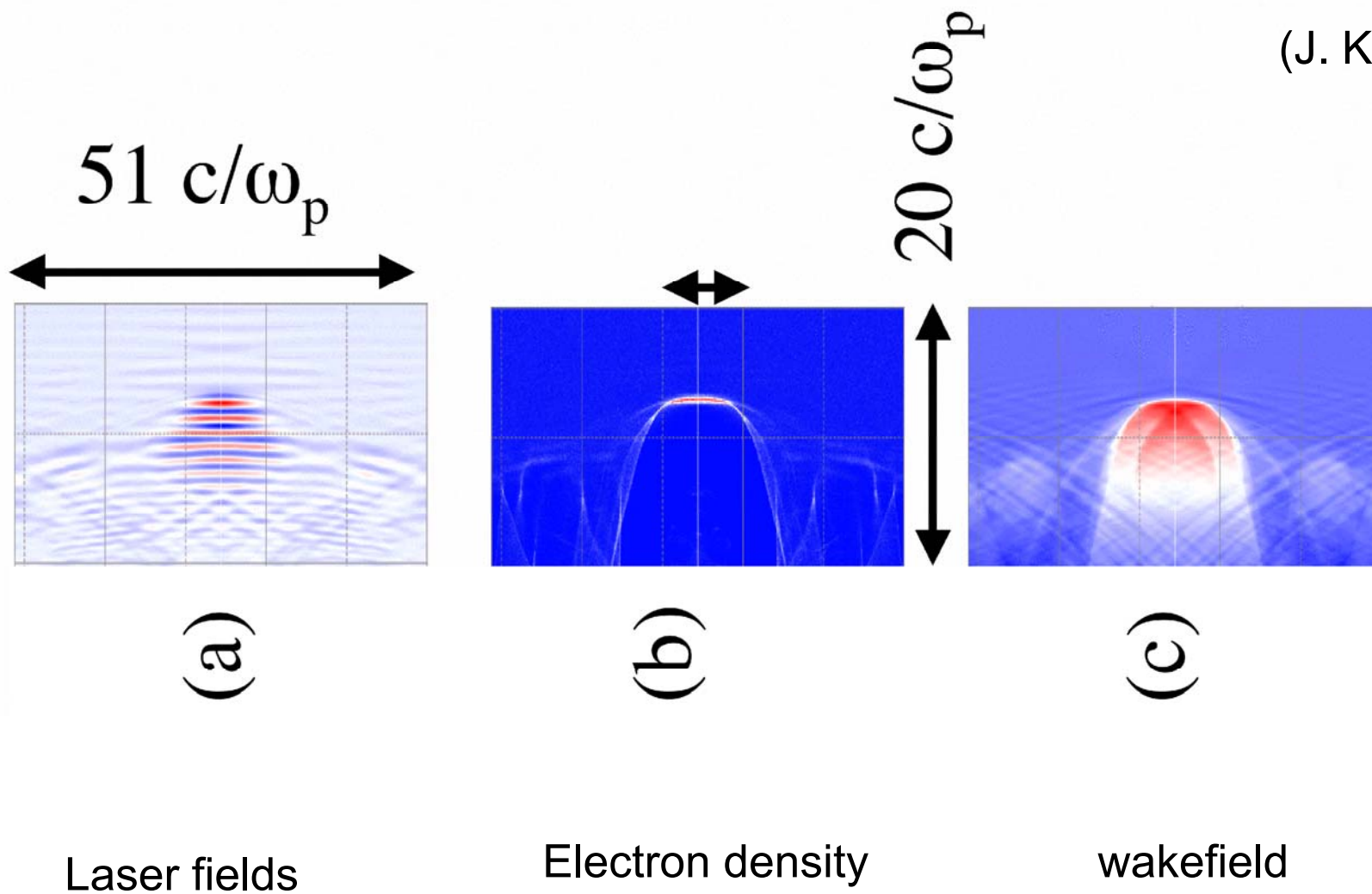

Theory of Wakefield without Wave-Break

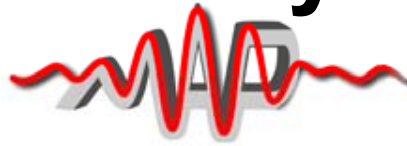

$$\Delta E \approx 2m_0c^2 a_0^2 \gamma_{ph}^2 = 2m_0c^2 a_0^2 \left(\frac{n_{cr}}{n_e} \right), \quad (\text{when 1D theory applies})$$

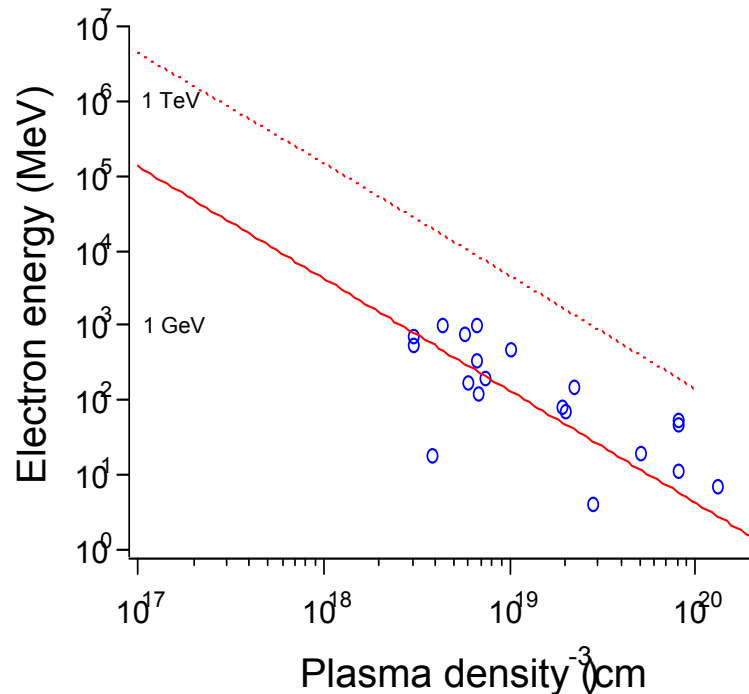

In order to avoid wavebreak,

$$a_0 < \gamma_{ph}^{1/2},$$

where

$$\gamma_{ph} = (n_{cr} / n_e)^{1/2}$$

$$L_d = \frac{2}{\pi} \lambda_p a_0^2 \left(\frac{n_{cr}}{n_e} \right),$$

dephasing length

$$L_p = \frac{1}{3\pi} \lambda_p a_0 \left(\frac{n_{cr}}{n_e} \right),$$

pump depletion length

MPQ Laser Acceleration Effort (1)

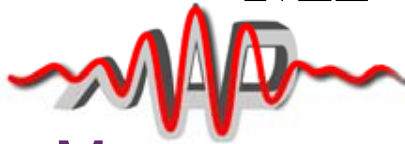

Monoenergy electron spectra: from **few-cycle laser** (LWS-10)

(K. Schmid, L. Veisz et al., PRL, 2009)

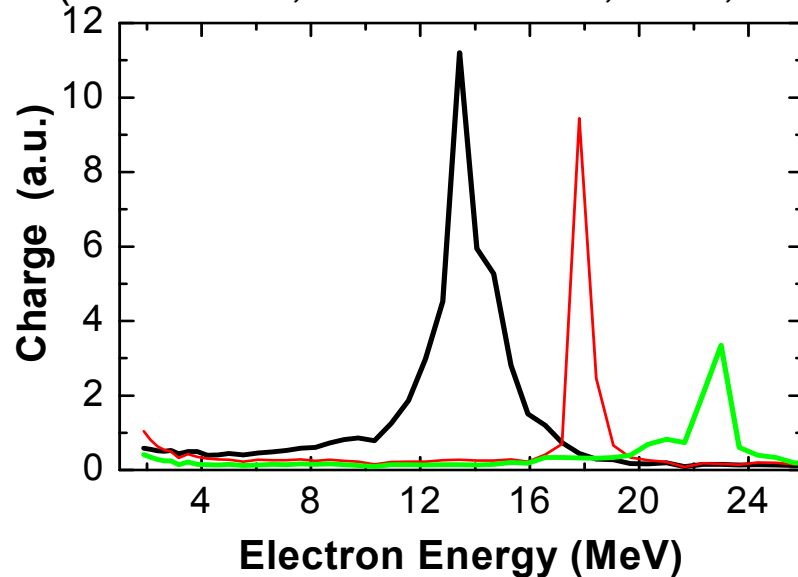

Large electron spectrometer 2 – 400 MeV

- No thermal background !
- Energies: 13.4 MeV, 17.8 MeV, 23 MeV
- FWHM energy spread: 11%, 4.3%, 5.7 %
- ~ 10 pC charge

Small electron spectrometer:

- Electron energies below 500keV
- No thermal background !
- 4.1 MeV (14%); 9.7 MeV (9.5%)

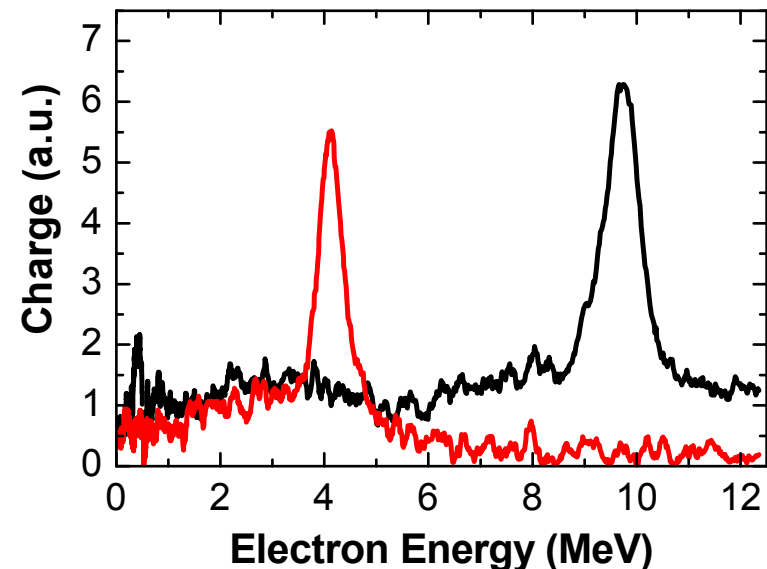

MPQ Laser Acceleration Effort (2)



Reproducible acceleration conditions

$$E \approx 169.7 \pm 2.0$$

MeV

1.1% peak energy
fluctuation !

$$\Delta E/E \approx 1.76 \pm 0.26\% \text{ RMS}$$

→ Essential property for
future table-top FEL operation

Source size image: provides
emittance measurement,
given the resolution can be
improved

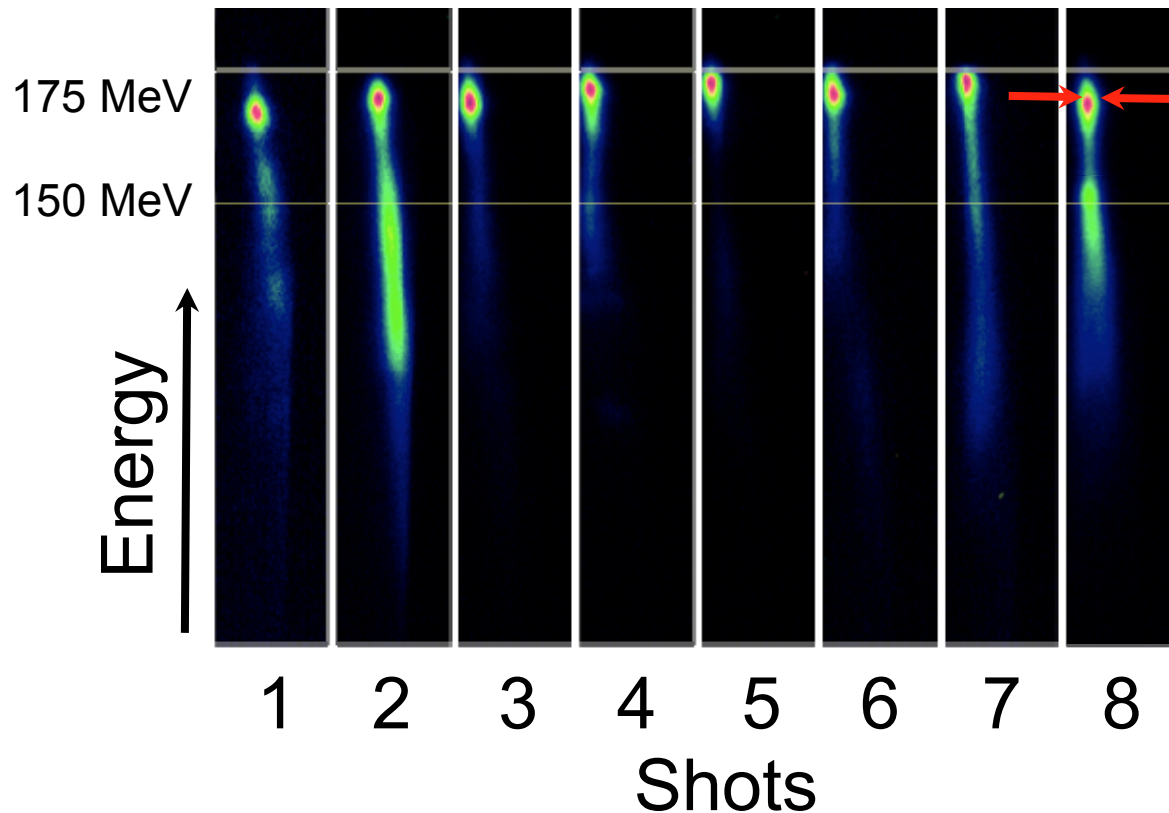

Electron trapping width

$$v_{tr,e} \sim c\sqrt{a_0}$$

(J. Osterhoff, ... S. Karsch, et al., PRL 2008)

MPQ Laser Acceleration Effort (3)

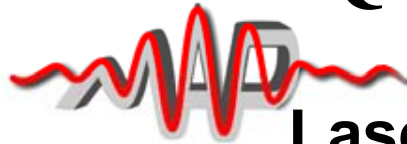

Laser-driven Soft-X-Ray Undulator Radiation

(F. Gruener, S. Karsch, et al., Nature Phys., 2009)

Characteristic undulator radiation spectrum

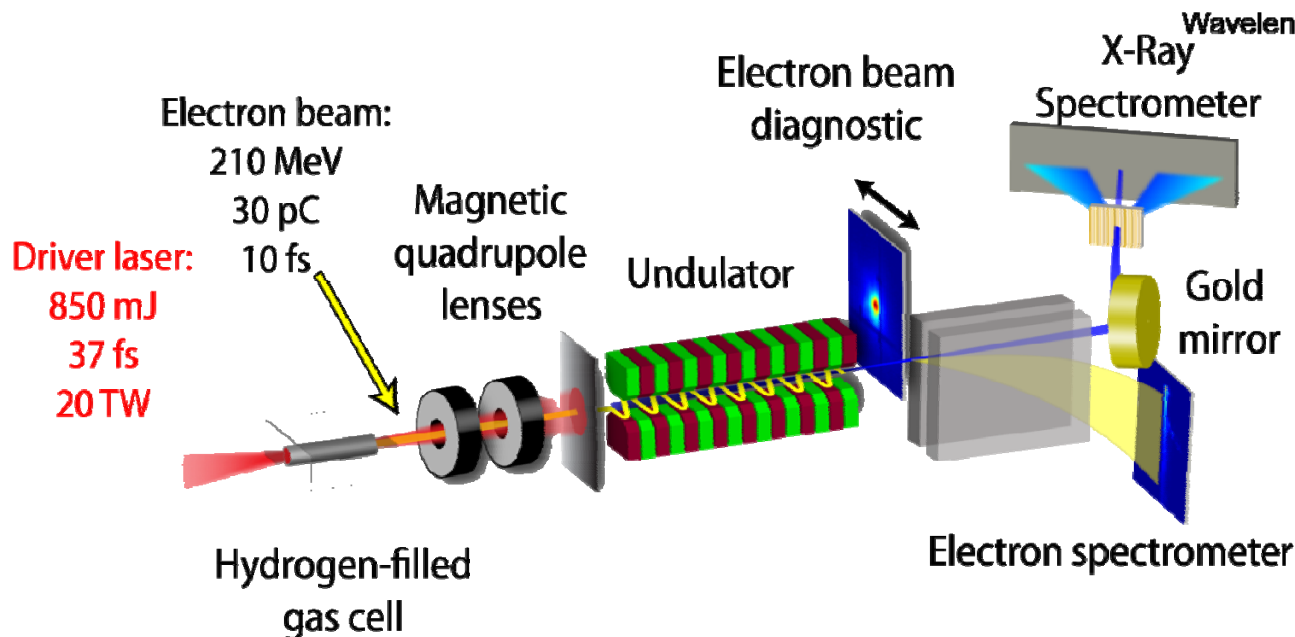
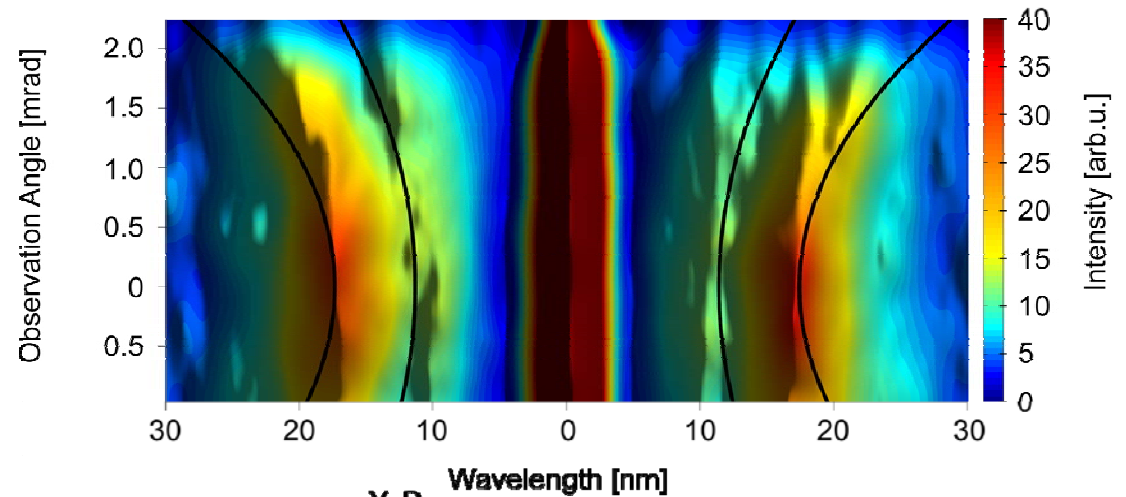

Intra-Operative Radiation Therapy (IORT)



LMU
www.attoworld.de

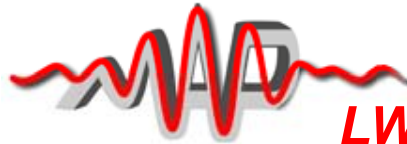

LWFA electron sources: *technology transferred to company*

NOVAC7

(HITESYS SpA)
RF-based

VS.

CEA-Saclay experim. source

Laser-based

El. Energy < 10 MeV
(3, 5, 7, 9 MeV)

El. Energy > 10 MeV
(10 - 45 MeV)

Peak curr. 1.5 mA

Peak curr. > 1.6 KA ←

Bunch dur. 4 μs

Bunch dur. < 1 ps ←

Bunch char. 6 nC

Bunch char. 1.6 nC

Rep. rate 5 Hz

Rep. rate 10 Hz

Mean curr. 30 nA

Mean curr. 16 nA

Releas. energy (1 min)
@9 MeV (≈dose)
18 J

Releas. energy (1 min)
@20 MeV (≈dose)
21 J



(A. Giulietti et al., Phys. Rev. Lett., 2008 : INFN)



Toward Coherent Control of Wakefields:



LMU
www.attoworld.de

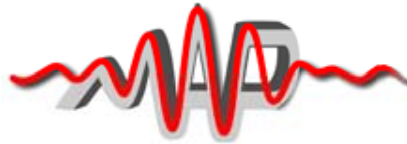

Frequency-domain Holography

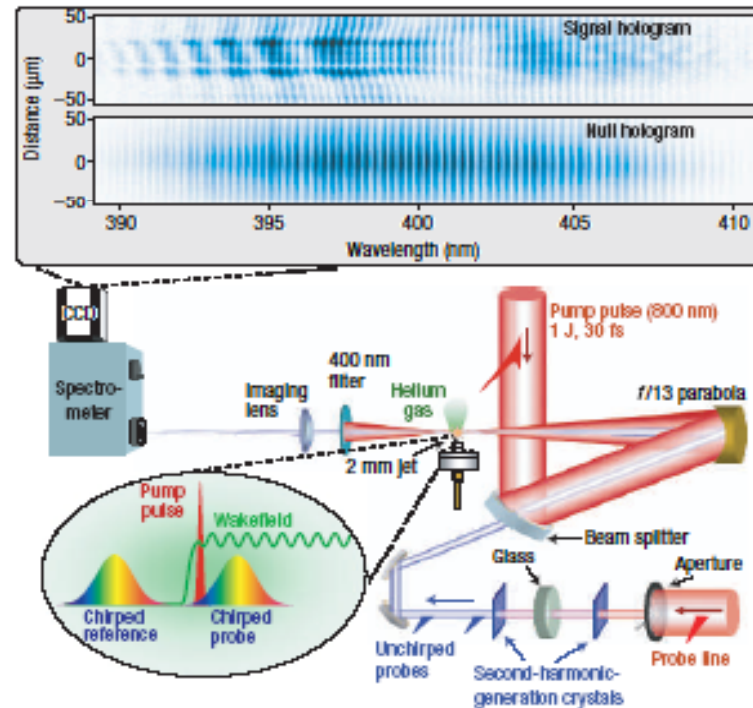
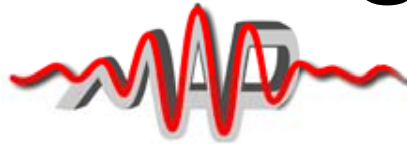

Figure 1 Experimental setup for FDH of laser wakefields. An $f/13$ parabola focuses an intense 30 fs pump pulse into a jet of helium gas, creating a plasma and laser wakefield. Two chirped, frequency-doubled 1 ps pulses, temporally synchronized and co-propagating with the pump, take holographic snapshots of the ionization front and wake. Phase alterations imposed on the trailing probe by these plasma disturbances are encoded in an FD Interferogram, shown at the top with (upper) and without (lower) a pump, recorded by a charge-coupled-device camera at the detection plane of an imaging spectrometer. The wake structure is recovered by Fourier-transforming this data.

(Matlis et al., 2006)

M.Downer (UTexas)

Snapshot of wakefields:



phase sensitive instantaneous single-shot detection

LETTERS

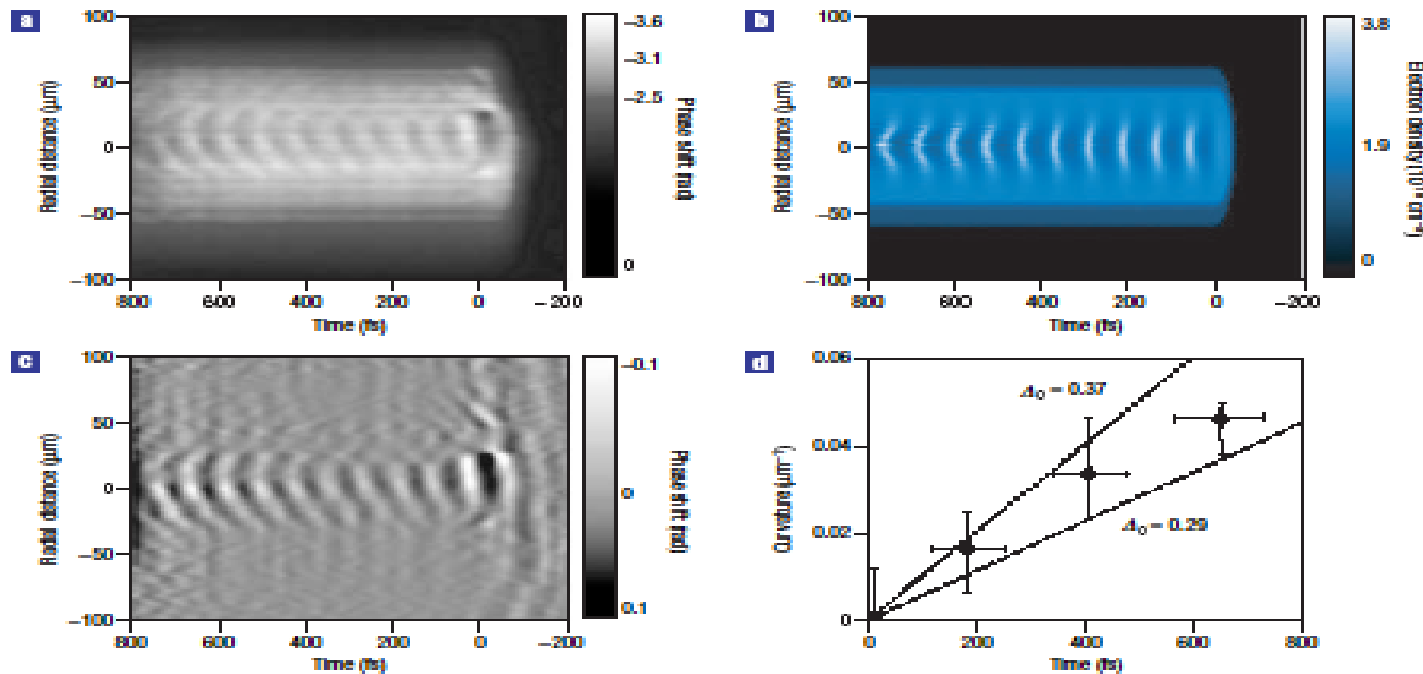
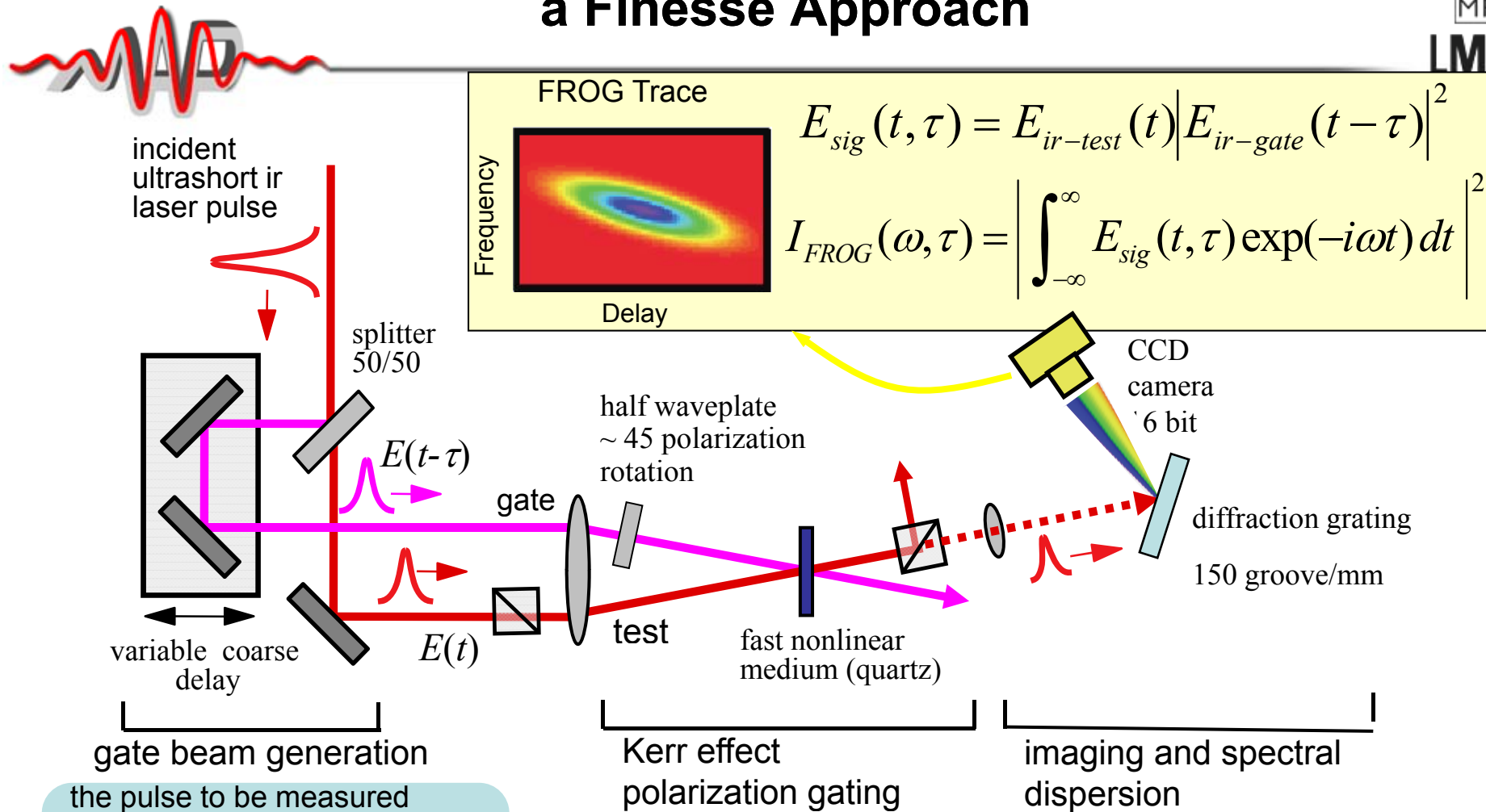

Figure 3 Strongly driven wake with curved wavelontrons. a, Probe phase profile $\Delta\phi_p(r, \zeta)$ for an ~ 30 TW pump, $n_e^{\text{max}} = 2.2 \times 10^{21} \text{ cm}^{-3}$ in the He^{2+} region. b, Simulated density profile $n_e(r, \zeta)$ near the jet centre. c, Same data as in a, with the background \bar{n}_e subtracted to highlight the wake. d, Evolution of the reciprocal radius of wavelontrons curvature behind the pump (data points), compared with calculated evolution (dashed lines) for indicated wake potential amplitudes. Each data point (except at $\zeta = 0$) averages over three adjacent periods. The horizontal error bars extend over the three periods averaged, and the vertical error bars extend over the range of fitted curvature values averaged.

(Matlis et al, 2006)

Polarization-Gated (PG) FROG: Single Pulse Dynamics a Finesse Approach



the pulse to be measured is split into a replica pair and one replica pulse (the 'gate') is delayed with a polarization rotation $\sim 45^\circ$

the two pulses are coincident
In an isotropic medium, Kerr-induced birefringence by the gate pulse yields an autocorrelation

grating provides spectral resolution for a 2D FROG trace

Single Shot Phase-Preserved fs Metrology of the Laser system and Laser-Plasma Interaction

Laser pulse spectrum modified in plasma;
 Dynamical information of ultrafast interaction 'encoded' onto the laser waveform
 Extract spectrum and phase of the transmitted laser pulse.

Feed back info to laser by simple feedback, neural net, genetic algorithm,....

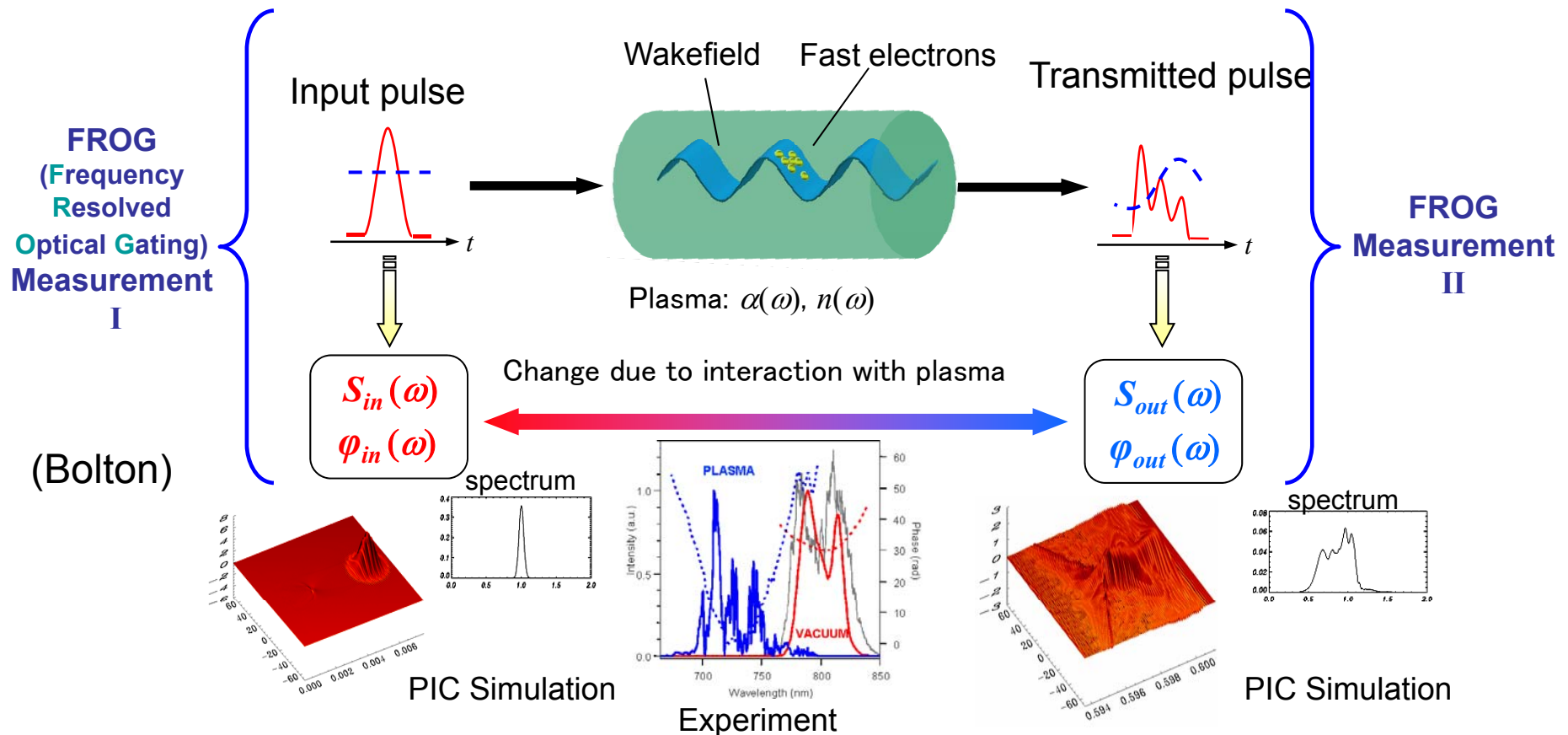

Another Finesse Single-shot Diagnosis: Electro-Optical Method

- can be noninvasive
- important for future accelerators
- all-optical:
 - optical controls in ideal laser setting
 - can apply optics sophistication
- jitterless (probe synchronized with laser driver)
- ultrafast – single bunch profile (~ 100 fsec)
- high repetition rate – multi-bunch timing jitter
- potential for feedback and beam (facility) control

Electrodeless Case

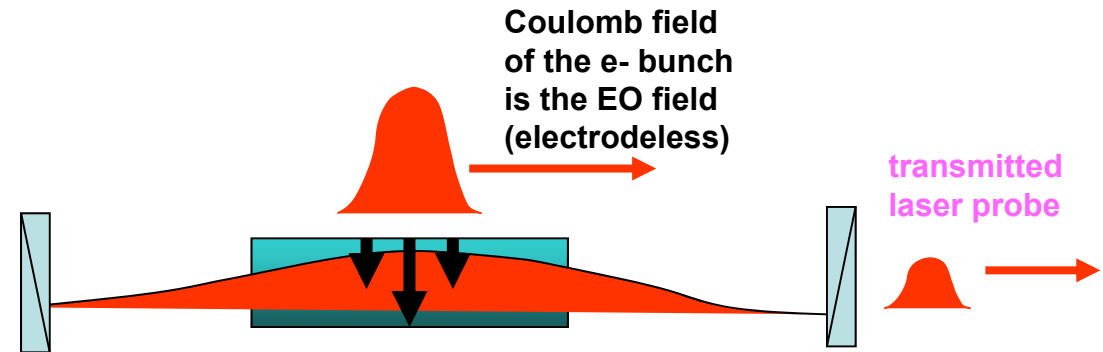

overlapping (coincident) portion of the laser probe pulse experiences the phase retardation in transit across the crystal

Use reference 'pi' field instead of 'pi' voltage:

$$\text{transmission, } T(E) \propto \sin^2 \left(\frac{\varphi_0}{2} - \frac{\pi}{2} \frac{E}{E_\pi} \right)$$

\Rightarrow want low E_π

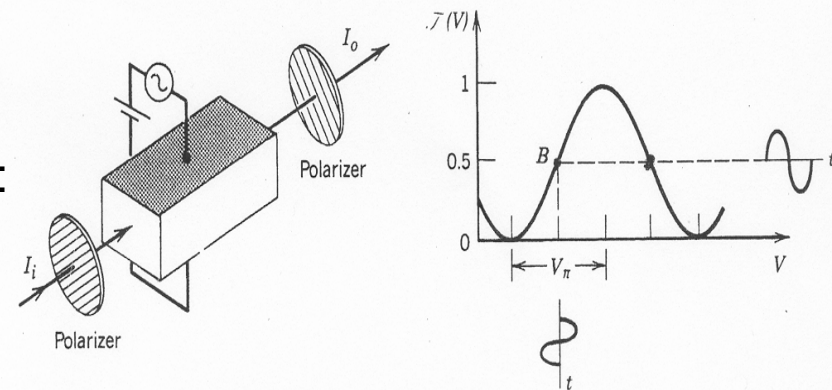

(a)

P. Bolton

(b)

EO Example: Spatial-Temporal Transcription with Pockels Effect

- require ultrashort probe and thinnest possible EO crystal
- optional horizontal line focus of probe at crystal

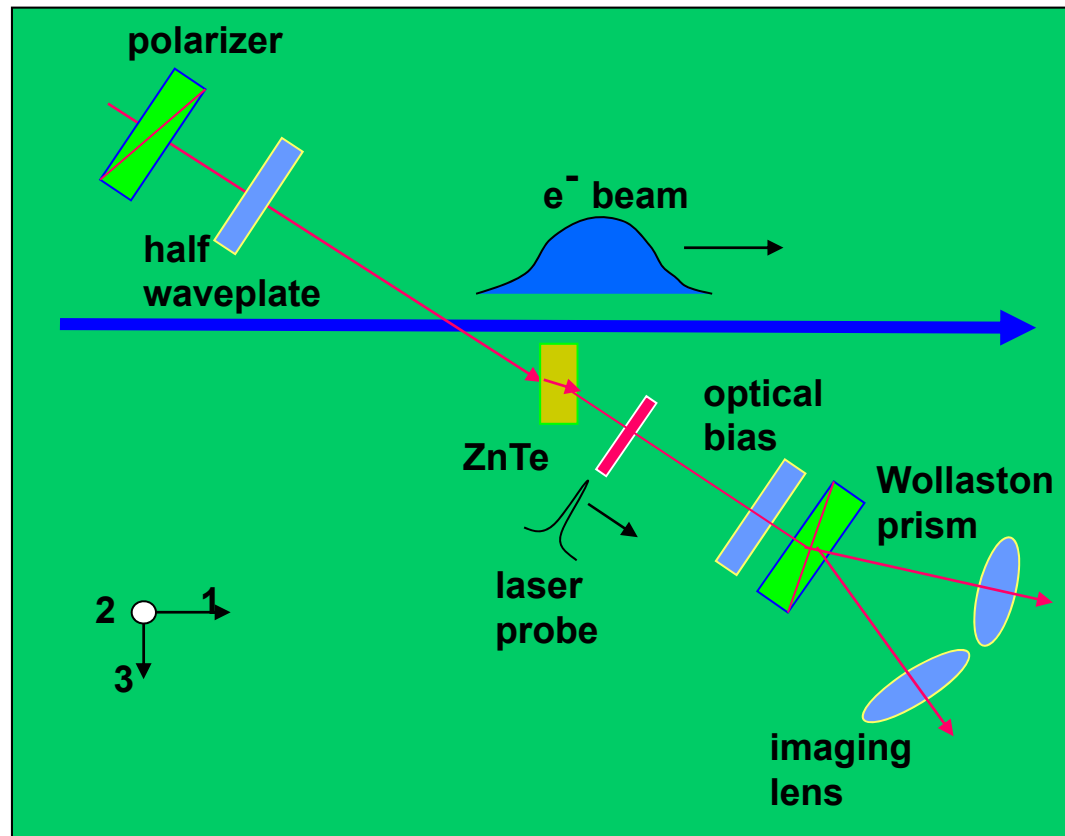

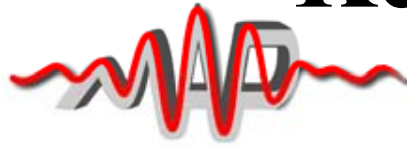

Key issues of future colliders

(T. Raubenheimer, SLAC, 2008)

Beam Acceleration

- * Largest cost driver for a linear collider is the acceleration
 - ILC geometric gradient is ~ 20 MV/m \rightarrow 50km for 1 TeV
- * Size of facility is costly \rightarrow higher acceleration gradients
 - High gradient acceleration requires high peak power and structures that can sustain high fields
 - Beams and lasers can be generated with high peak power
 - Dielectrics and plasmas can withstand high fields
- * Many paths towards high gradient acceleration
 - High gradient microwave acceleration } ~ 100 MV/m
 - Acceleration with laser driven structures } ~ 1 GV/m
 - Acceleration with beam driven structures } ~ 1 GV/m
 - Acceleration with laser driven plasmas } ~ 10 GV/m
 - Acceleration with beam driven plasmas } ~ 10 GV/m



World Lab's goal =

Put SLAC on a football field



**SLAC's 2 mile linac
(50GeV)**



Laser acceleration =

- no material breakdown threshold (→ 3 orders higher gradient);
- 3 orders finer accuracy, 2 orders more efficient **laser** needed

Apollon as a driver for 100GeV

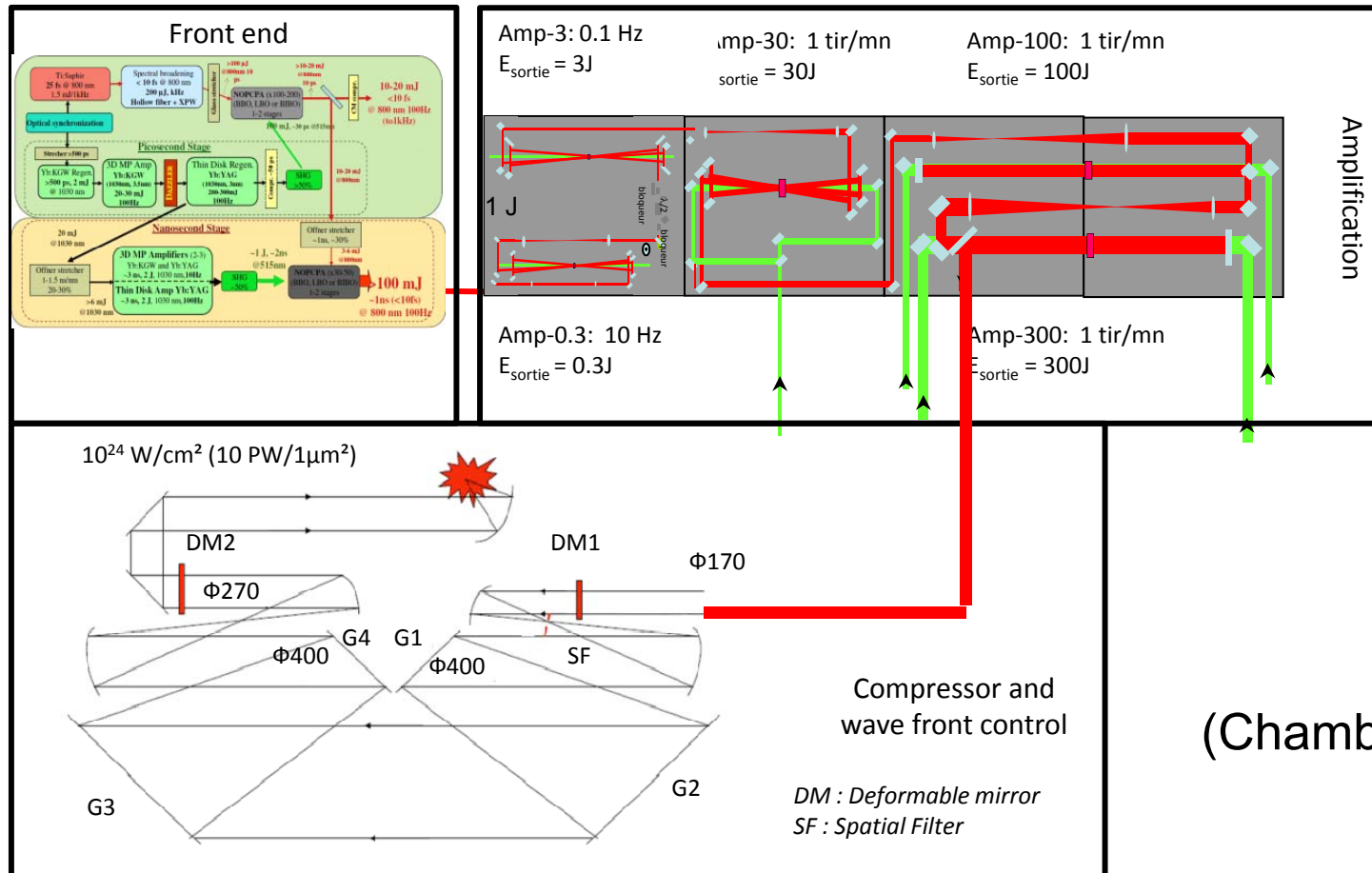
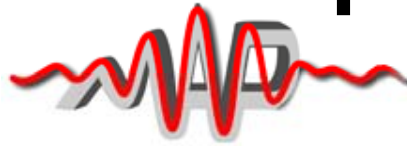

150J Apollon split into 10 beams, driving 10 of 10GeV stages

Collider application: Early version(1997)



Studies of Laser-Driven 5 TeV e^+e^- Colliders in Strong Quantum Beamstrahlung Regime

M. Xie¹, T. Tajima², K. Yokoya³
and S. Chattopadhyay¹

¹Lawrence Berkeley National Laboratory, USA
²University of Texas at Austin, USA
³KEK, Japan

(AIP Proc. **398**, 1997)

Abstract.

We explore the multidimensional space of beam parameters, looking for preferred regions of operation for a e^+e^- linear collider at 5 TeV center of mass energy. Due to several major constraints such a collider is pushed into certain regime of high beamstrahlung parameter, Υ , where beamstrahlung can be suppressed by quantum effect. The collider performance at high Υ regime is examined with IP simulations using the code CAIN. Given the required beam parameters we then discuss the feasibility of laser-driven accelerations. In particular, we will discuss the capabilities of laser wakefield acceleration and comment on the difficulties and uncertainties associated with the approach. It is hoped that such an exercise will offer valuable guidelines for and insights into the current development of advanced accelerator technologies oriented towards future collider applications.

INTRODUCTION

It is believed that a linear collider at around 1 TeV center of mass energy can be built more or less with existing technologies. But it is practically impossible to go much beyond that energy without employing a new, yet largely unknown method of acceleration. However, apart from knowing the details of the future technologies, certain collider constraints on electron and positron beam parameters are considered to be quite general and have to be satisfied, e.g. available wall plug power and the constraints imposed by collision processes: beamstrahlung, disruption, backgrounds, etc. Therefore it is appropriate to explore and chart out the preferred region in parameter space based on these constraints, and with that hopefully to offer valuable guide-

With a plasma density of 10^{17}cm^{-3} , such a gradient can be produced in the linear regime with more or less existing T³ laser, giving a plasma dephasing length of about 1 m [13]. If we assume a plasma channel tens of μm in width can be formed at a length equals to the dephasing length, we would have a 10 GeV acceleration module with an active length of 1 m. Of course, creating and maintaining a plasma channel of the required quality is no simple matter. To date, propagation in a plasma channel over a distance of up to 70 Rayleigh lengths (about 2.2 cm) of moderately intense pulse ($\sim 10^{15}\text{W}/\text{cm}^2$) has been demonstrated [14]. New experiment aiming at propagating pulses with intensities on the order of $10^{18}\text{W}/\text{cm}^2$ (required for a gradient of 10 GeV/m) is underway [13].

Table 1. Beam Parameters at Three Values of Beam Power

CASE	$P_b(\text{MW})$	$N(10^8)$	$f_c(\text{kHz})$	$\epsilon_y(\text{nm})$	$\beta_y(\mu\text{m})$	$\sigma_y(\text{nm})$	$\sigma_z(\mu\text{m})$
I	2	0.5	50	2.2	22	0.1	0.32
II	20	1.6	156	25	62	0.56	1
III	200	6	416	310	188	3.5	2.8

Table 2. Results Given By the Formulas

CASE	Υ	D_y	F_{oide}	n_γ	δ_E	n_p	$\mathcal{L}_g(10^{35}\text{cm}^{-2}\text{s}^{-1})$
I	3485	0.93	0.89	0.72	0.2	0.19	1
II	631	0.29	0.89	0.72	0.2	0.12	1
III	138	0.081	0.91	0.72	0.2	0.072	1

Table 3. Results Given By CAIN Simulations

CASE	n_γ	δ_E	σ_e/E_0	n_p	$\mathcal{L}/\mathcal{L}_g(W_{\text{cm}} \in 1\%)$	$\mathcal{L}/\mathcal{L}_g(W_{\text{cm}} \in 10\%)$
I	1.9	0.38	0.42	0.28	0.83	1.1
II	0.97	0.26	0.36	0.12	0.65	0.80
III	0.84	0.21	0.32	0.06	0.62	0.75

Although a state-of-the-art T³ laser, capable of generating sub-ps pulses with 10s of TW peak power and a few Js of energy per pulse [11], could almost serve the need for the required acceleration, the average power or the rep rate of a single unit is still quite low, and wall-plug efficiency inadequate. In addition, injection scheme and synchronization of laser and electron pulse from

Incorporated collider physics at collision point (beamstrahlung, Oide limit, etc.)

Toward energy frontier : Multistaging (earliest version, 1985)

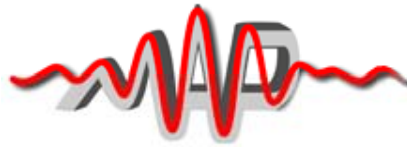

(pre-CPA version)

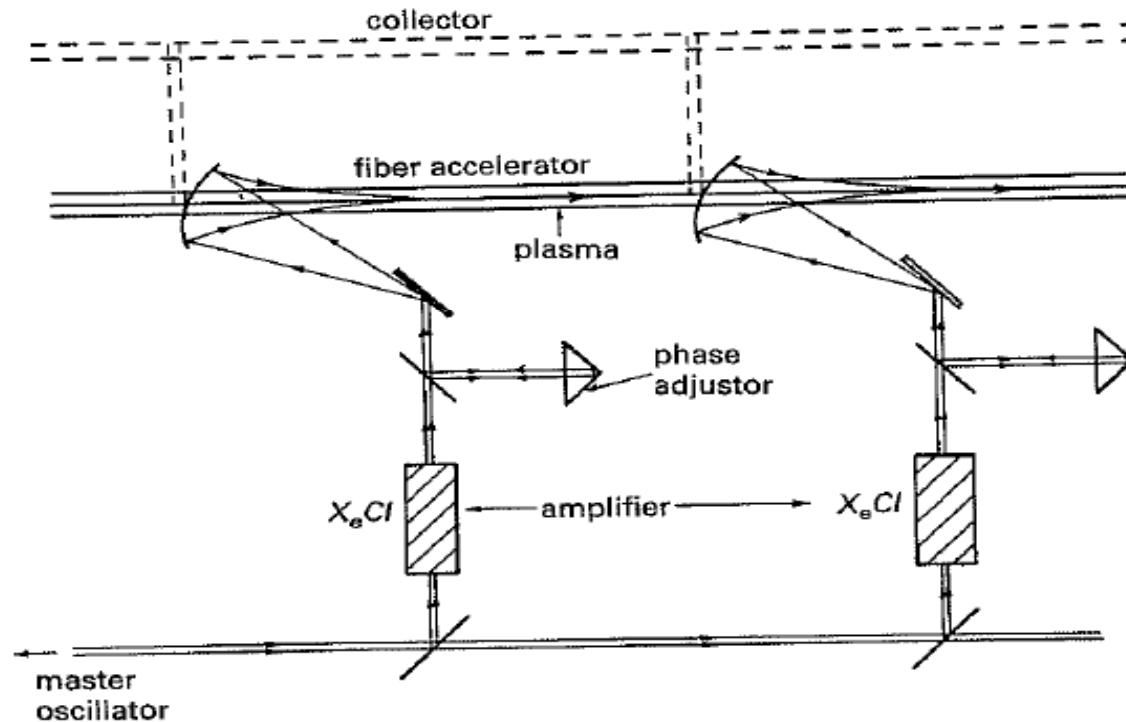
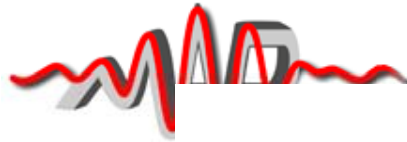

FIGURE 34. A conceptual plasma fiber accelerator with laser staging amplification *in situ*. The separation between the modules is characterized by the sum of the focal length and the pump depletion length. An example of X_eCl lasers is taken.

(Tajima, Laser Part Beams, 1985)



Multi-stage acceleration

Particle Dynamics and its Consequences in Wakefield Acceleration in a High Energy Collider

S. Cheshkov, T. Tajima, W. Horton and K. Yokoya*

AIP Proc. **472**
(1999)

*Department of Physics and Institute for Fusion Studies
The University of Texas at Austin
Austin, Texas 78712 USA*

** KEK National Laboratory for High Energy Physics, Japan*

Abstract. The performance of a wakefield accelerator in a high energy collider application is analyzed by use of a nonlinear dynamics map built on a simple theoretical model of the wakefield generated by the laser pulse (or whatever other method) and a code based on this map [1]. The crucial figures of merit for such a system other than the final energy include the emittance (that determines the luminosity). The more complex the system is, the more "opportunities" the system has to degrade the emittance (or entropy of the beam). Thus our map guides us to identify where the crucial elements lie that affect the emittance. If the focusing force of the wakefield is strong when there

Transverse focusing/defocusing need to be mitigated. Plasma channel ideal

Renewed Interest in $\gamma\text{-}\gamma$ Collider

Large amount of cost down possible by $\gamma\gamma$ collider
perhaps half (or even a third)
clearer Higgs physics than e^+e^- collider
likely Higgs mass $\sim 120\text{GeV}$ (\leftarrow input from LHC)

2.1. HIGGS

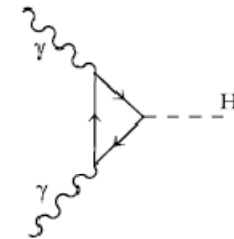

Figure 2.1: Couplings of the Higgs boson to two photons.

1.1. $\gamma\gamma$ COLLIDER

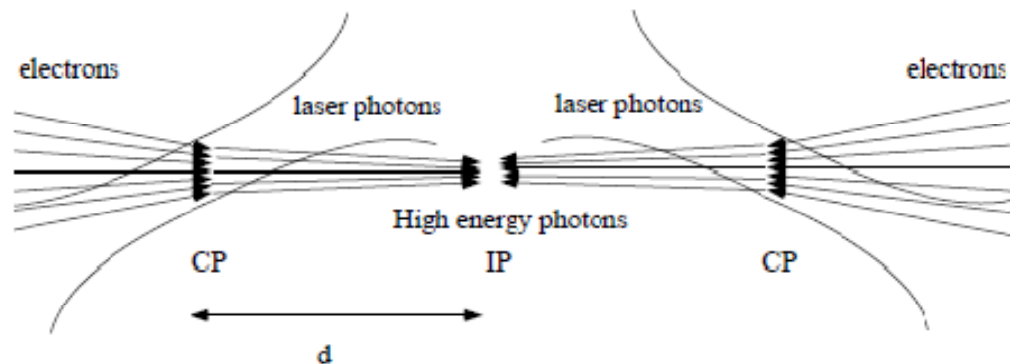

Figure 1.2: Conceptual view of the interaction region of a $\gamma\gamma$ collider

1.1 $\gamma\gamma$ Collider

The idea of generating high-energy photons by backward-scattered Compton photons is discussed in [29, 30, 31, 72, 73] and recent status is summarized in [80, 27]. In $\gamma\gamma$ colliders, photon beams are generated by the inverse Compton scattering of electron- and laser-beams just before the interaction point. By this method, a photon beam of the highest energy close to the original electron beam can be

New:
Study Group started
at KEK-JAEA,
ELI discussion
(Sept, 2008)

\rightarrow a new strategy
for HEP?
more affordable

(N. Toge)

High energy beam dump: a nasty business

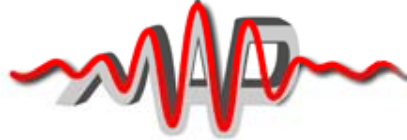

Stopping range

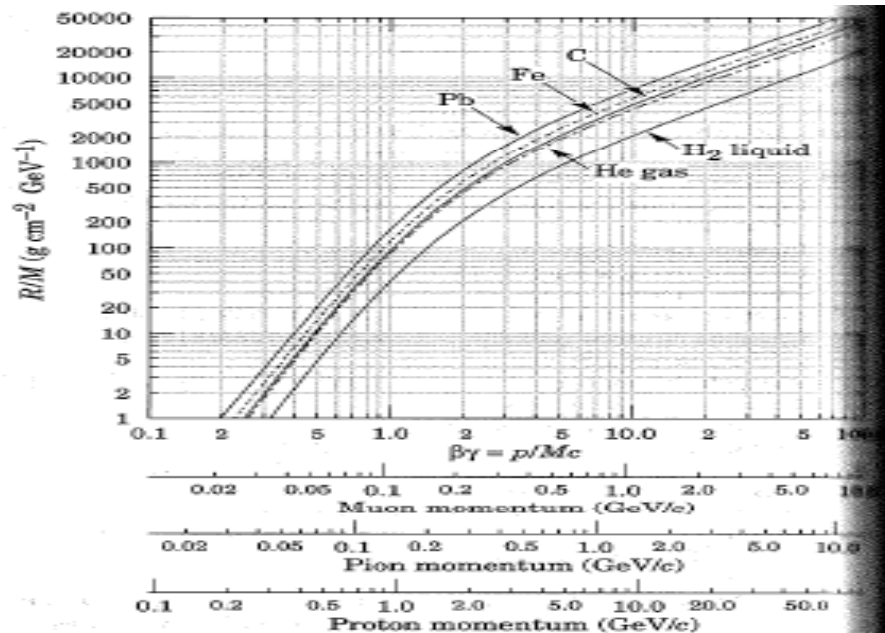

Figure 26.4: Range of heavy charged particles in liquid (bubble chamber) hydrogen, helium gas, carbon, iron, and lead. For example: For a K^+ whose momentum is $700 \text{ MeV}/c$, $\beta\gamma = 1.42$. For lead we read $R/M \approx 396$, and so the range is 195 g cm^{-2} .

$$T_{\text{max}} = \frac{2m_e c^2 \beta^2 \gamma^2}{1 + 2\gamma m_e/M + (m_e/M)^2} \quad (26)$$

In older references [3,4] the "low-energy" approximation $T_{\text{max}} = 2m_e c^2 \beta^2 \gamma^2$, valid for $2\gamma m_e/M \ll 1$, is often implicit. For pion in copper, the error thus introduced into dE/dx is greater than 6% at 100 GeV. The correct expression should be used.

Radiation length of high energy charged particles

- (1) Stopping length increases rapidly as energy \uparrow
- (2) Amount of radiation increases rapidly as energy \uparrow
- (3) Fraction of useful interaction decreases rapidly as energy \uparrow

Stopping power due to collective force

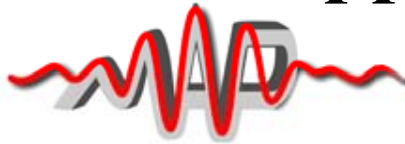

Bethe-Bloch stopping power in matter

Plasma stopping power due to individual force

$$-(dE / dx)_{ind} = (F / \beta^2) \ln(m_e v^2 / e^2 k_D)$$

That due to collective force (perturbative regime)

$$-(dE / dx)_{coll} = (F / \beta^2) \ln(k_D v / \omega_{pe})$$

$$F = 4\pi e^4 n_{e,m} / m_e c^2 = e^2 k_{pe,m}^2$$

(Ichimaru, 1973)

Plasma stopping power due to short-bunch wakefield (wavebreak regime)

$$-(dE / dx)_C = m_e c \omega_{pe} (n_b / n_e)$$

(Wu et al, 2009)

Greater by **several orders** in gas over Bethe-Bloch in solid

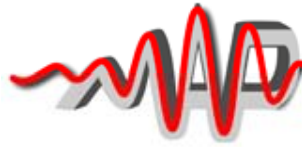

Wakefield Decelerator: attention to the downstream

Can we employ collective force to tackle this problem?

Given the TeV-beam, its decelerating field in the plasma is E_{decel} , which is on the order of the Tajima-Dawson field,

$$E_{\text{decel}} = \frac{m_e \omega_p c}{e} \quad (3)$$

or numerically,

$$E_{\text{decel}} = \sqrt{\frac{n_p}{n_{14}}} \text{ GeV/m} \quad (4)$$

Here n_{14} is the density of 10^{14} cm^{-3} . If we choose $n_p = 10^{14} \text{ cm}^{-3}$, the beam particles lose 1 GeV per meter in the plasma. To stop a 1 TeV beam in 100 m would require a plasma with $n_p = 10^{16} \text{ cm}^{-3}$. The corresponding plasma frequency then becomes 900 GHz.

We now estimate the radial extent of the plasma oscillation driven by the intense electron beam with N electrons. Most of the plasma oscillation energy will be within this radial distance to the plasma column axis. We assume a blow-out regime in which all plasma electrons are driven out radially by the beam while the plasma ions stay stationary providing the Coulomb force drawing the plasma electrons back toward the column axis. Consider a plasma electron initially at rest at radial position r_0 . After the driving electron bunch passes by, this plasma electron receives a radial kick yielding an initial radial velocity

$$\dot{r}_0 = \frac{2Ne^2}{m_e c r_0} \left(1 - e^{-r_0^2/2\sigma_r^2}\right) \quad (5)$$

where σ_r is the rms radial size of the driving electron beam. We have assumed that the driving beam has a circular transverse cross-section, and that the motion of the plasma electron is nonrelativistic. Maximum kick occurs when $r_0 \approx 1.6\sigma_r$, in which case, the initial velocity reads

$$\dot{r}_0 \approx \frac{0.9Ne^2}{m_e c \sigma_r} \quad (6)$$

(Tajima and Chao, 2008)

- stop short in mm, rather than in m
- dump without much radiation/activation
- convert its energy into electricity

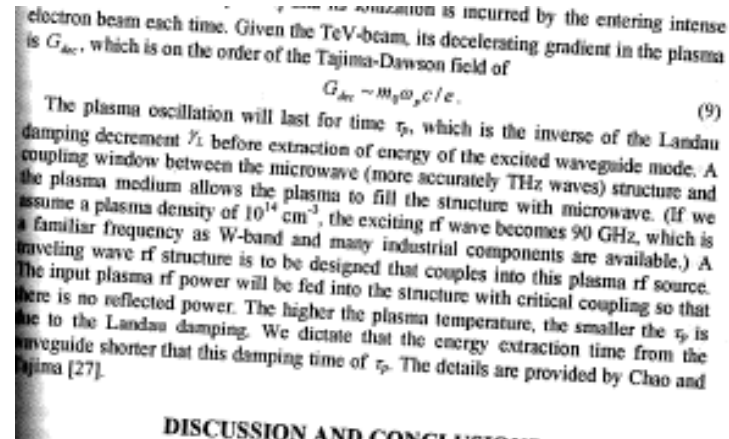

(Kando et al, 2008)

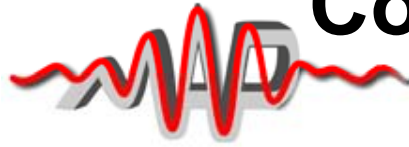

Collective deceleration over mm

Results of computer simulation

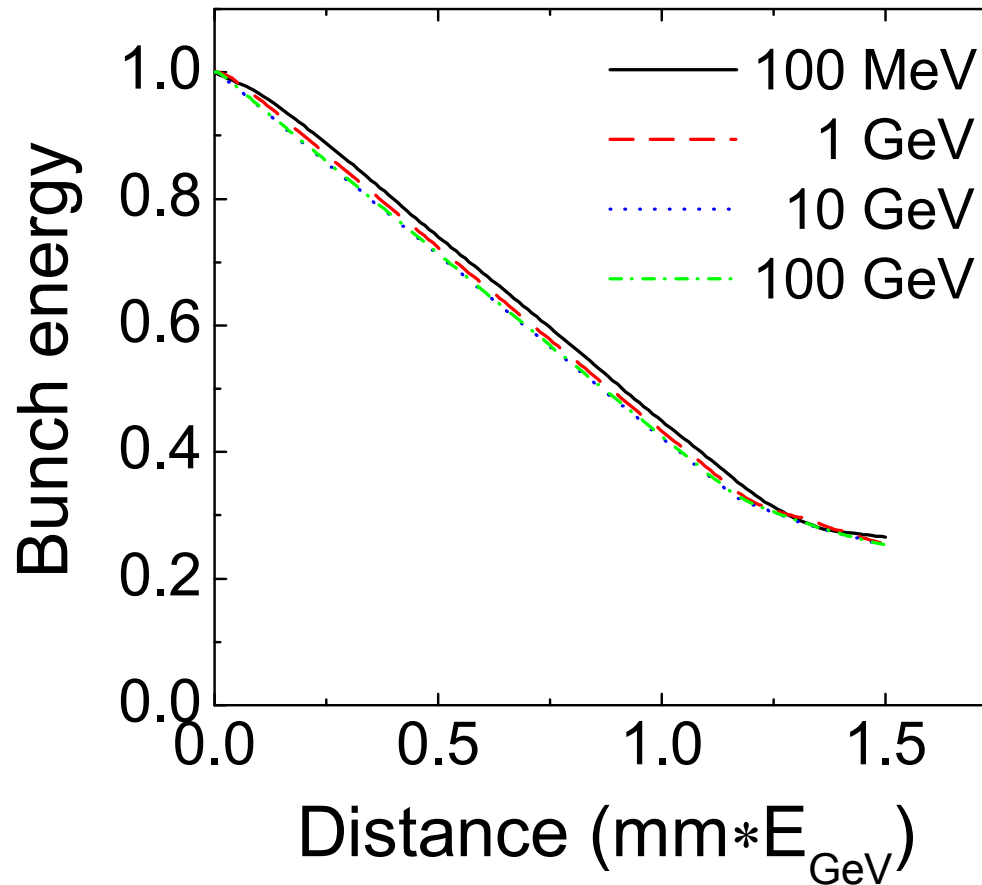

isomorphic, regardless of energies

(Wu et al, 2009)

Accelerator

Evolution of Accelerators and their Possibilities

(Suzuki, 2008)



$E=40 \text{ MV/m}$

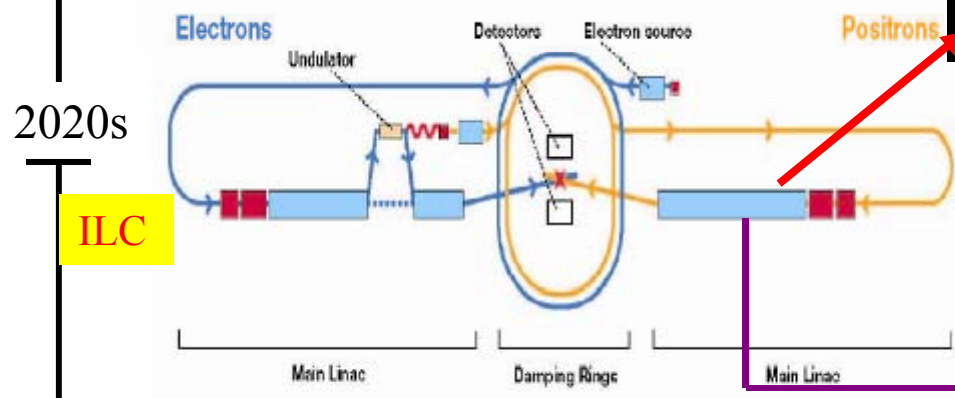

ILC

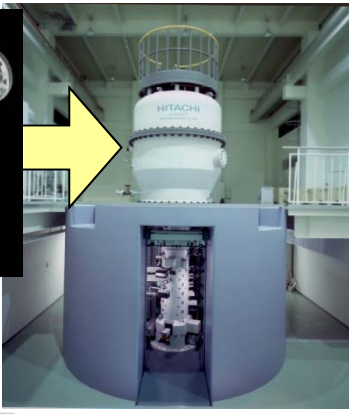
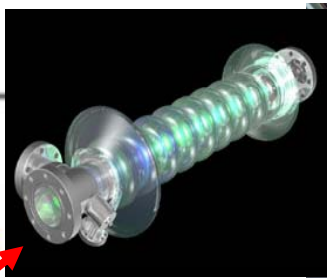

Ultra-High Voltage STEM with Superconducting RF cavity

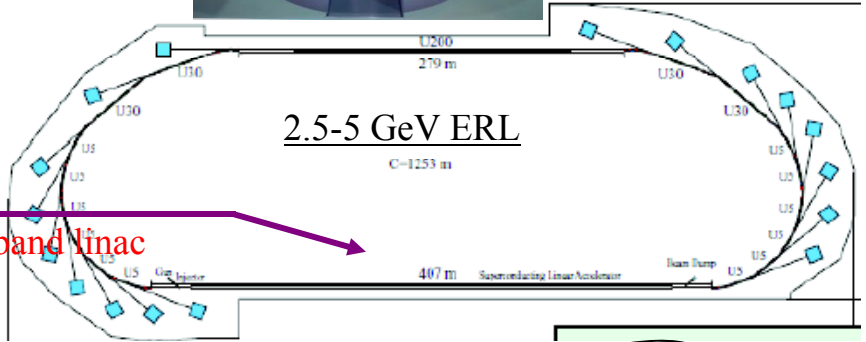

Superconducting L-band linac

$E=200 \text{ MV/m}$

DRIVE BEAM

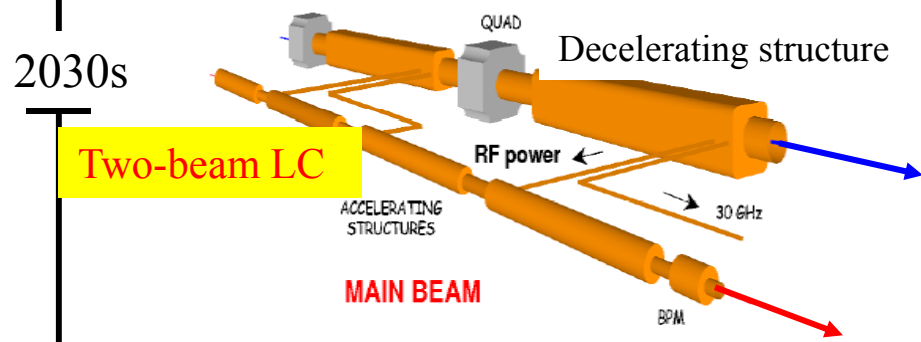

Two-beam LC

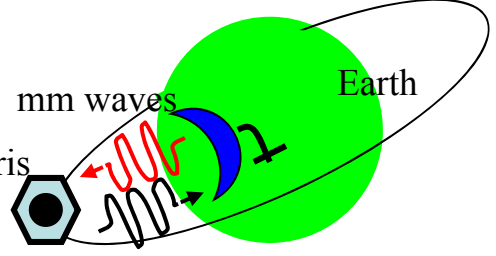

Earth-based space debris radar

$E=10 \text{ GV/m}$

10cm-10GeV Plasma Channel Accelerator

2040s

Laser-plasma LC

09/3/9

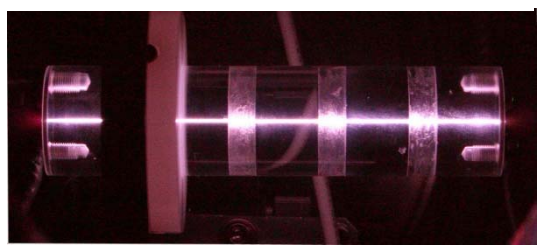
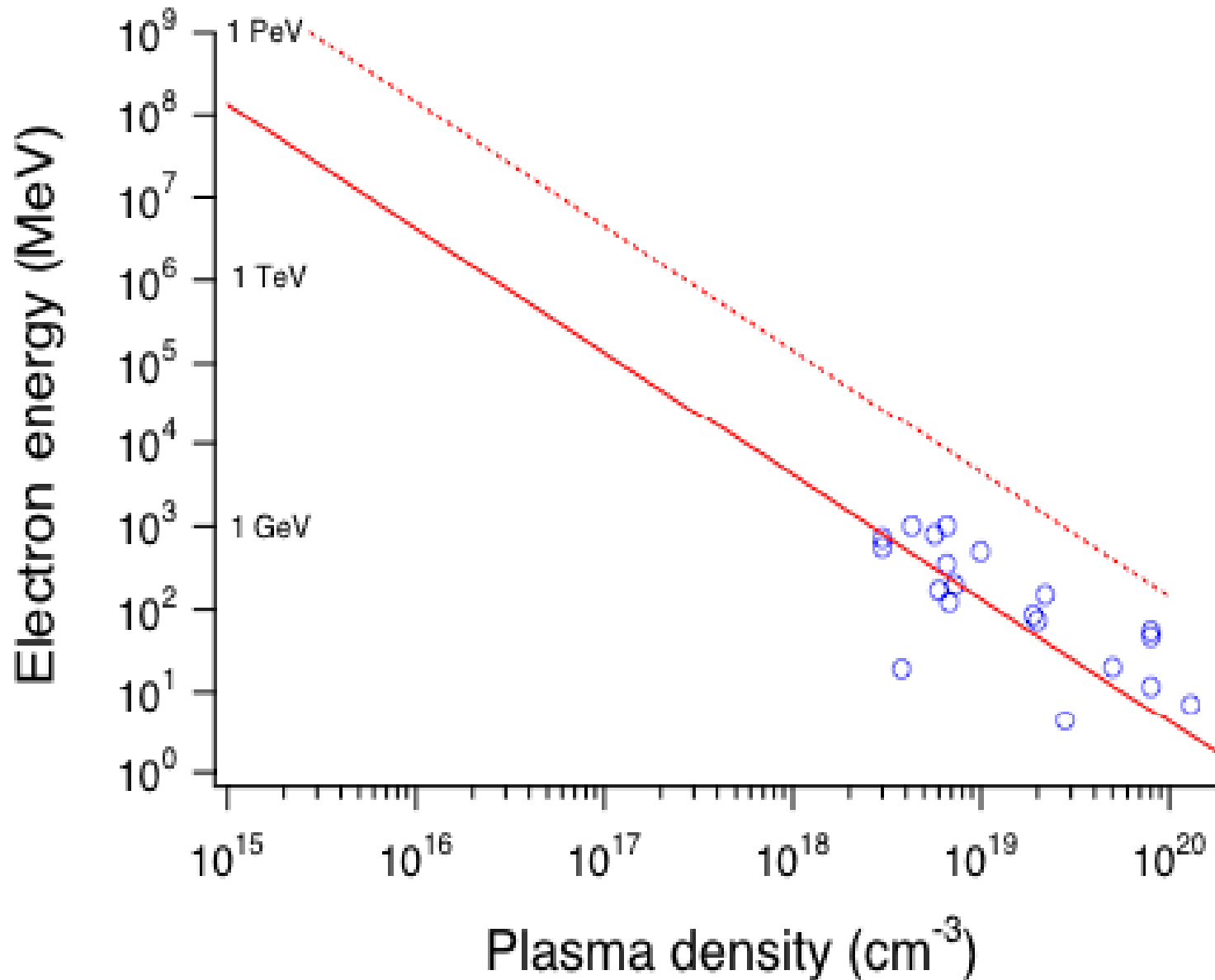
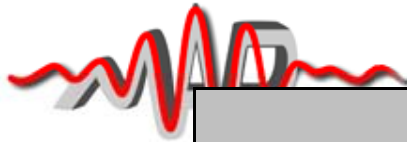

Table-top high energy accelerator

Laser acceleration energy scaling



PeV Acceleration



Parameters	Symbol	Case I	Case II	Case III	unit
total energy gain	ΔW	1	1	1	PeV
total laser energy	$E_{L,t}$	4.1×10^2	8.8	4.1	MJ
number of stages	N_{stage}	1	100	1000	
plasma density	n_e	1.8×10^{15}	3.9×10^{16}	1.8×10^{17}	cm^{-3}
gamma factor	γ_{ph}	7.9×10^2	1.7×10^2	79	
wavelength	λ	1	1	1	μm
norm. laser amplitude	a_0	56	26	18	
laser energy/stage	$E_{L,l}$	4.1×10^4	88	4.1	kJ
peak power	P	4.2×10^4	4.2×10^2	42	PW
pulse duration	τ	9.8×10^2	2.1×10^2	98	fs
pump depletion length	L_p	1.2×10^4	57	3.9	m
dephasing length	L_d	6.2×10^3	29	2	m
total acc length	$L_{acc,t}$	6.2×10^3	2.9×10^3	2.0×10^3	m
spot radius	w_0	7.9×10^2	1.7×10^2	79	μm
number of electrons	N_{beam}	1.7×10^{11}	1.7×10^{10}	5.5×10^9	

PeV γ from Crab Nebula

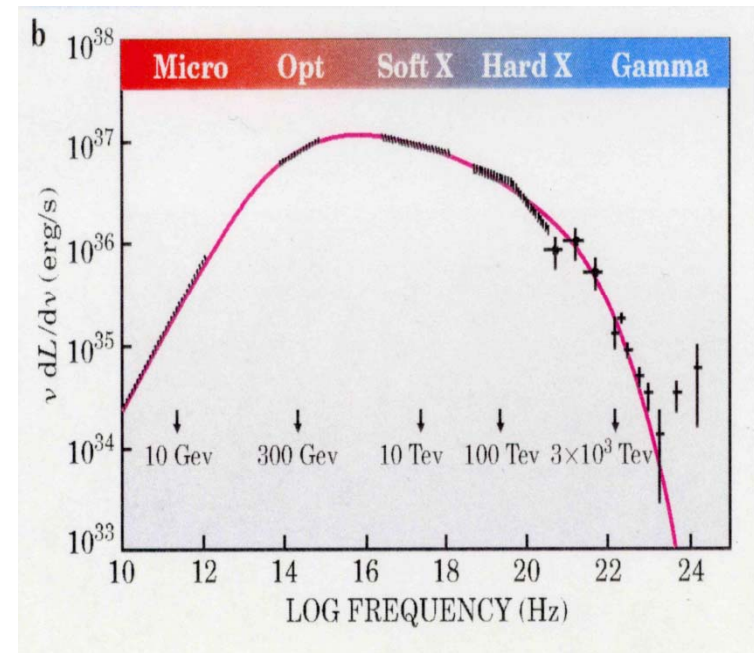

Can we see manifestation of quantum gravity, Lorentz variance in high energy γ ?
How PeV electrons accelerated?

The Crab Pulsar, a city-sized, magnetized neutron star spinning 30 times a second, lies at the center of this composite image of the inner region of the well-known Crab Nebula. The spectacular picture combines optical data (red) from the Hubble Space Telescope and x-ray images (blue) from the Chandra Observatory, also used in the popular Crab Pulsar movies. Like a cosmic dynamo the pulsar powers the x-ray and optical emission from the nebula, accelerating charged particles and producing the eerie, glowing x-ray jets. Ring-like structures are x-ray emitting regions where the high energy particles slam into the nebular material.

Special theory of relativity OK?

doi:10.1038/nature08574



nature

www.nature.com

LETTERS

A limit on the variation of the speed of light arising from quantum gravity effects

A list of authors and their affiliations appears at the end of the paper

A cornerstone of Einstein's special relativity is Lorentz invariance—the postulate that all observers measure exactly the same speed of light in vacuum, independent of photon-energy. While special relativity assumes that there is no fundamental length-scale associated with such invariance, there is a fundamental scale (the Planck scale, $l_{\text{Planck}} \approx 1.62 \times 10^{-33}$ cm or $E_{\text{Planck}} = M_{\text{Planck}}c^2 \approx 1.22 \times 10^{19}$ GeV), at which quantum effects are expected to strongly affect the nature of space-time. There is great interest in the (not yet validated) idea that Lorentz invariance might break near the Planck scale. A key test of such violation of Lorentz invariance is a possible variation of photon speed with energy^{1–7}. Even a tiny variation in photon speed, when accumulated over cosmological light-travel times, may be revealed by observing sharp features in γ -ray burst (GRB) light-curves². Here we report the detection of emission up to ~ 31 GeV from the distant and short GRB 090510. We find no evidence for

scale (when E_{ph} becomes comparable to $E_{\text{Planck}} = M_{\text{Planck}}c^2$). For $E_{\text{ph}} \ll E_{\text{Planck}}$, the leading term in a Taylor series expansion of the classical dispersion relation is $|v_{\text{ph}}/c - 1| \approx (E_{\text{ph}}/M_{\text{QG},n}c^2)^n$, where $M_{\text{QG},n}$ is the quantum gravity mass for order n and $n = 1$ or 2 is usually assumed. The linear case ($n = 1$) gives a difference $\Delta t = \pm(\Delta E/M_{\text{QG},1}c^2)D/c$ in the arrival time of photons emitted together at a distance D from us, and differing by $\Delta E = E_{\text{high}} - E_{\text{low}}$. At cosmological distances this simple expression is somewhat modified (see Supplementary Information section 4).

Because of their short duration (typically with short substructure consisting of pulses or narrow spikes) and cosmological distances, GRBs are well-suited for constraining LIV^{3,11,12}. Individual spikes in long¹³ (of duration > 2 s) GRB light-curves (10–1,000 keV) usually show¹⁴ intrinsic lags: the peak of a spike occurs earlier at higher photon-energies. However, there are either no lags or very short lags

(Abdo et al, 2009)

γ -ray signal (GRB) from primordial GRB



NATURE

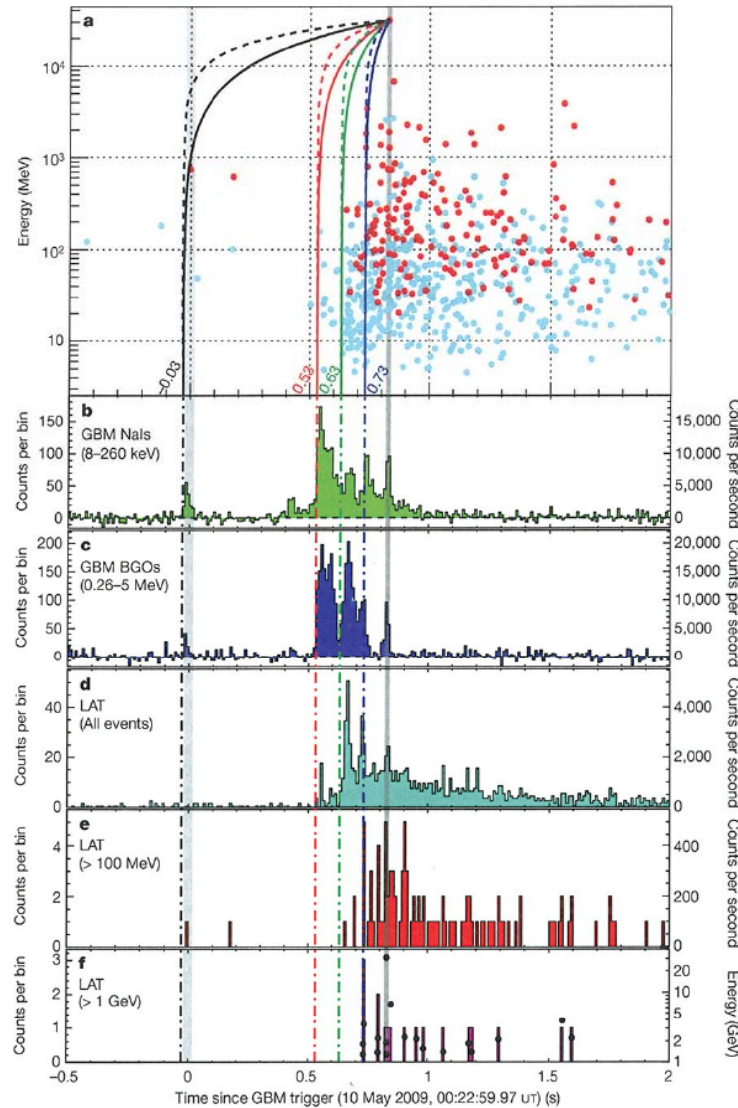

**Energy-dependent
Photon mass?
limit is pushed up
to near Planck mass**

**PeV γ (from e-)
Can explore this**

(Abdo, et al, 2009)

Figure 1 | Light curves of GRB 090510 at different energies. a, Energy lowest to highest energies. f also overlays energy versus arrival time for each

ICUIL – ICFA joint effort

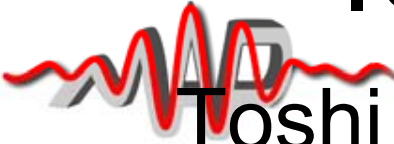

Toshi Tajima (ICUIL chair) aims to promote relationship between ICUIL and ICFA:

- Common interest in laser driven acceleration
- Contacted Suzuki and Wagner: invited Tajima to speak at ICFA meeting (Oct., 2008)
- Leemans appointed in November 2008 to lay groundwork for joint standing committee activities
- ICFA endorsed initiation of joint efforts on February 13, 2009
- Joint Task Force formed (2009)

(from Leemans)

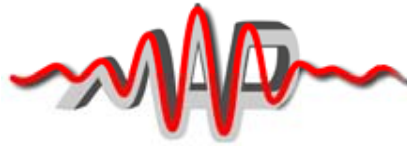

Proposed activity

- Joint workshop on laser technology for future colliders
 - Planning underway by Barty, Leemans and Sandner
 - Convene international panel of experts on laser technology
 - Create a comprehensive survey of the requirements for laser based light and particle sources with emphasis on sources that can advance light and particle science AND require lasers beyond the state of the art or state of current use.
 - Identify future laser system requirements
 - Identify key technological bottlenecks
 - From projected system requirements, provide visions for technology paths forward to reach survey goals and outline required laser technology R&D steps that must be undertaken
 - Write technical report

(Leemans)

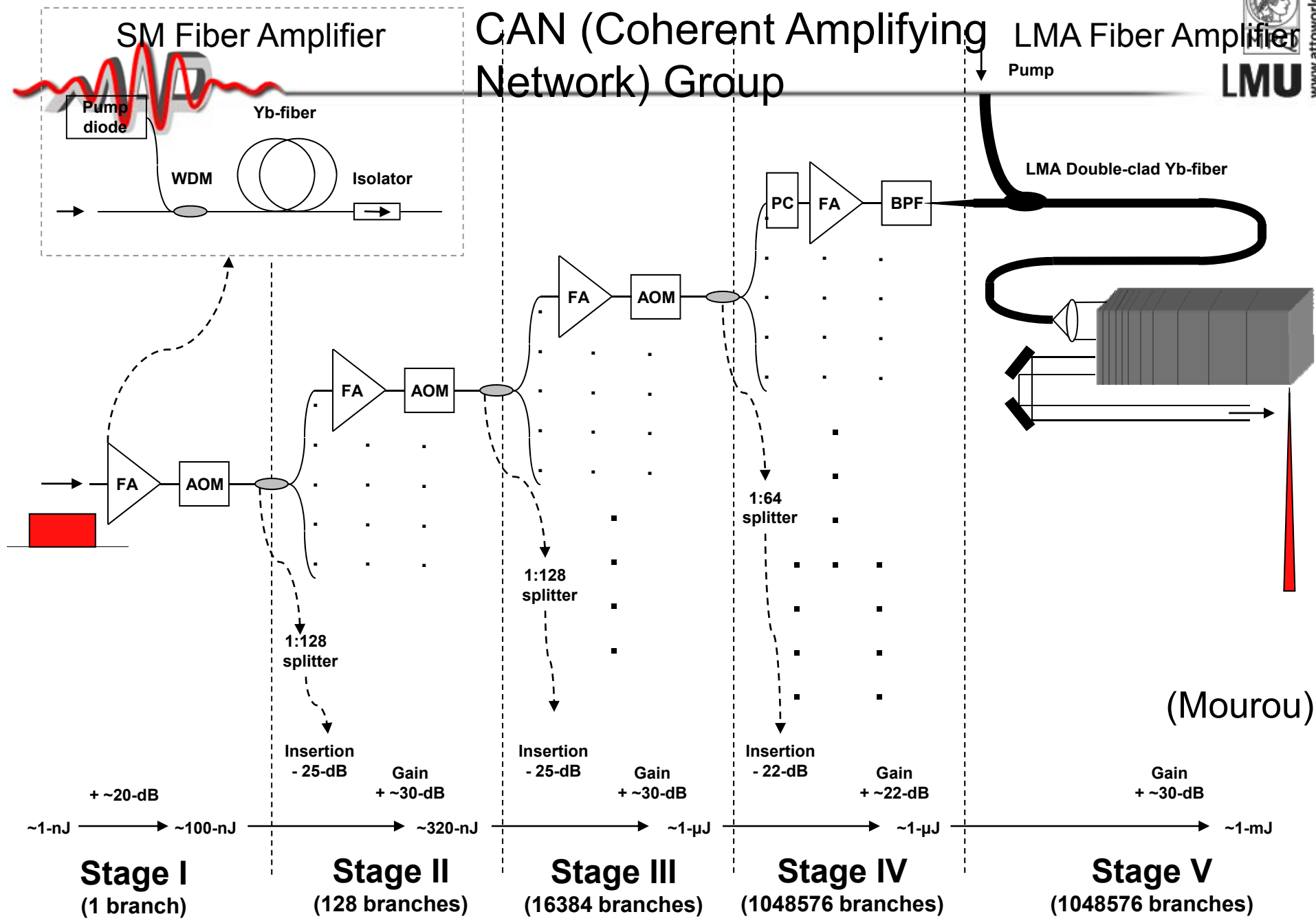

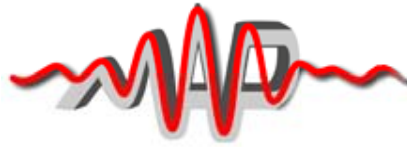

Fiber for collider (150 MW bundle)

Because the transport fibers are lossless they will be assembled in a bundle just before the focusing optics. They will be all coherently phased.

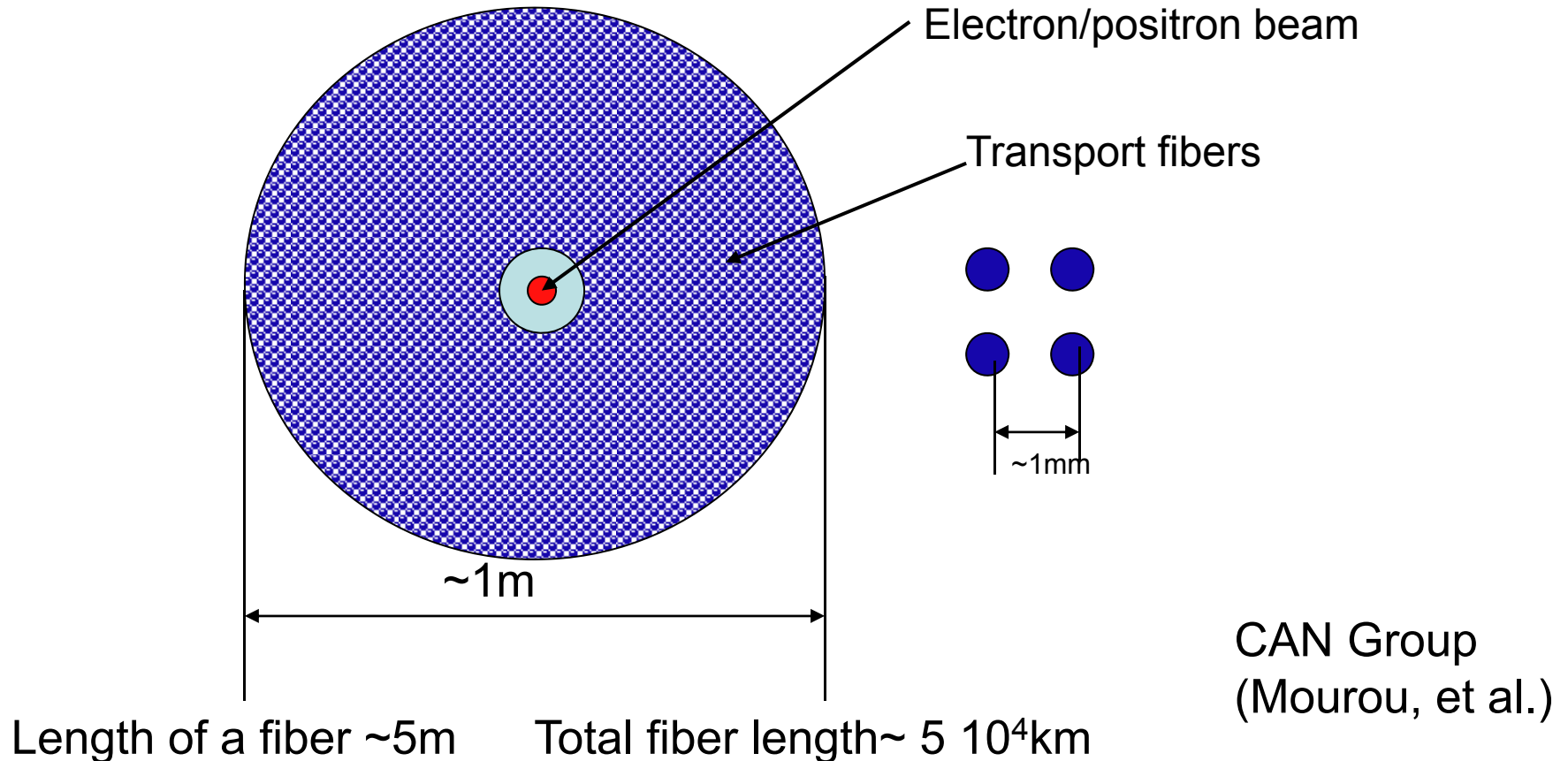

Suggestions to ICFA-ICUIL JTF

- Science efforts by US, Europe, Asia mounting to extend the laser technology toward HEP accelerators
- Technology efforts still lacking in developing suited laser technology(ies) for HEP accelerators
- Technologies: emerging and credible for these
- ICFA-ICUIL collaboration: important guide of direction
- Lead lab(s) necessary to lead and do work on this initiative
- World Test Facility ('World Lab')?
- Other applications important (light sources, medical, nuclear waste management, fusion, defense, etc.)

(Tajima; April 10, 2010)

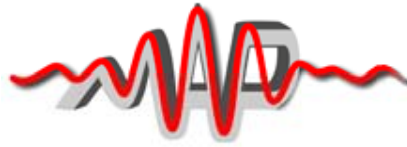

Conclusions

- **Laser** electron acceleration: experimentally well established; its unique properties getting known
- **Laser** has come around to match the condition set 30 years ago; Still some ways to go to realize the dream (such as **ELI**)
- GeV electrons; 10 GeV soon; 100GeV considered; TeV **laser** collider contemplated; PeV ?
- Beam control: greater attention necessary
- **Other applications**: already beginning, soon to flourish : radiolysis, intraoperative therapy, bunch decelerator, nuclear detection, compact FEL source, compact radiation sources, ultrafast diagnosis,...)
- Need to establish a center which carries **laser** acceleration science proof-of-principle experiments at collider level energies, as well as incubates collider-fit **laser** driver technology

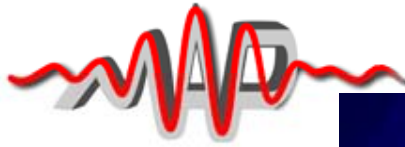

Centaurus A:

cosmic
wakefield
linac?

Merci Beaucoup!