

$$g = ? \bar{g}$$

P. Debu, P. Dupré, P. Grandemange, L. Liskay, B. Mansoulié, P. Pérez, J-M Rey, N. Ruiz, Y. Sacquin



APERÇU

- ❖ Motivation théorique et expérimentale
- ❖ Principe de l'expérience
- ❖ Activités positons
 - Production de positons
 - ✓ Rapides
 - ✓ Lents
 - Piégeage des positons
 - Production de positronium
- ❖ Dernières étapes franchies et planning

Motivation

Principe d'équivalence faible

*"Si un corps neutre de test est placé en un point de l'espace-temps avec une vitesse initiale, alors sa trajectoire sera indépendante de sa structure interne et de sa **composition**."*

⇔ Simultanéité de la chute des corps

⇔ Egalité masse inerte et masse grave

Cela a été testé avec une très bonne précision dans un grand nombre d'expériences du type de celle d'Eötvös, avec de la matière...

Certains modèles ajoutent des champs scalaires et vectoriels au champ tensoriel, lesquels violent le principe d'équivalence.

Theory and Experiment

$$V = -G \frac{mm'}{r} \left(1 \mp a e^{-\frac{r}{v}} + b e^{-\frac{r}{s}} \right)$$

↑
↑
↑
↑

Newton
 Supergravity:

has component of repulsive gravity

J. Scherk, Phys. Lett. B (1979) 265.

Discussion and experimental constraints :

M. Nieto and T. Goldman, Phys. Rep. 205 (1991) 221

Motivation for antigravity in General Relativity:

G. Chardin, Hyperfine Interactions 109 (1997) 83

Constraints

$K_0 - \bar{K}_0$

SN1987a

Cyclotron frequency p/\bar{p}

No direct measurement exists

Charged antimatter

e^+ or \bar{p} (e.m. shielding)

Neutral antimatter

\bar{n} hard to slow down

Ps short lifetime

\bar{H} cooling limit mK

\bar{H}^+ cooling limit μK

AEGIS(CERN)

GBAR

Principle of the experiment

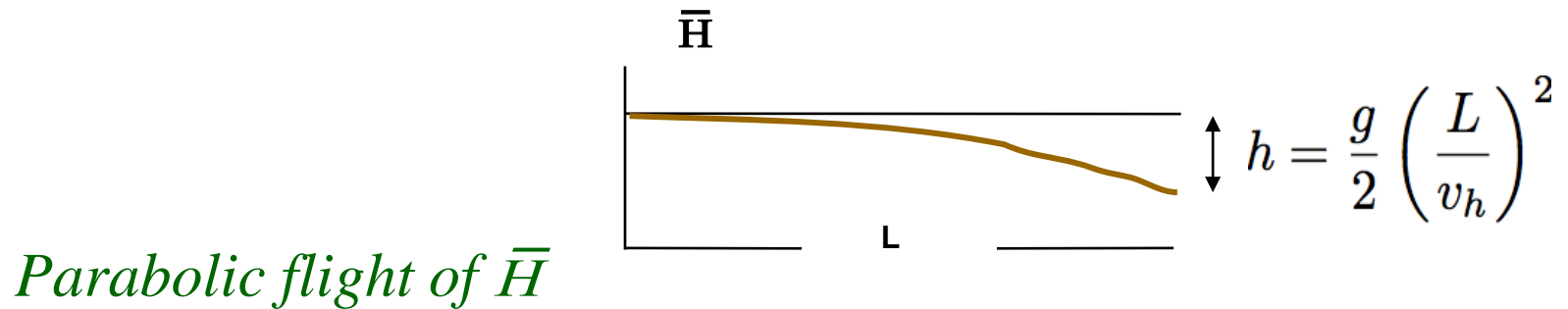

- $L = 1 \text{ m}$ et $v_h = 500 \text{ m/s} \rightarrow h = 20 \text{ }\mu\text{m}$ ($E_c(\bar{H}) \approx 15 \text{ K} \approx 1 \text{ meV}$)

\rightarrow *AEGIS* experiment with \bar{H} (neutral)

- $L = 0.1 \text{ m}$ et $v_h = 0.5 \text{ m/s} \rightarrow h = 20 \text{ cm}$ ($E_c(\bar{H}) \approx 15 \text{ }\mu\text{K} \approx 1 \text{ neV}$)

\rightarrow *Gbar* project using \bar{H}^+ to produce slow \bar{H}

P. Pérez et al, LOI CERN –SPSCI-038 (2007) Irfu, Riken, Tokyo U.

- Precision depends on the spread of the initial vertical speed

\bar{g} experiment using \bar{H}^+

- Produce ion \bar{H}^+
- Capture ion \bar{H}^+
- Sympathetic cooling $20 \mu\text{K}$
- Photodetachment of e^+
- Time of flight

Error dominated by temperature of \bar{H}^+

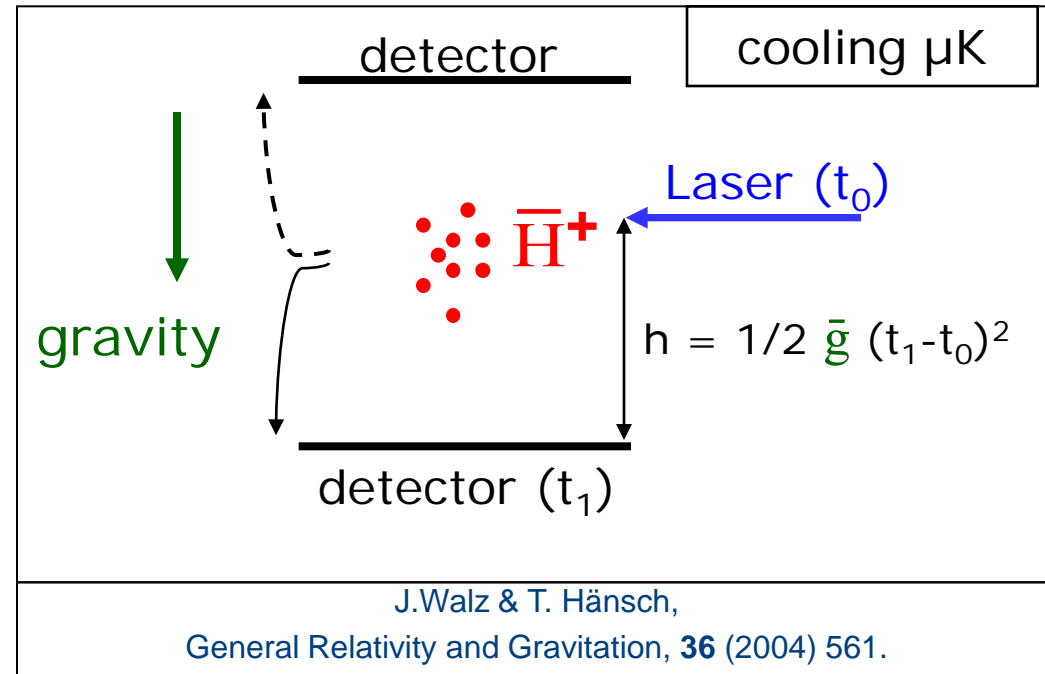

Relative Precision on \bar{g} :

\bar{H}^+ in ion trap	$\Delta g/g$
$5 \cdot 10^5$	0.001
10^4	0.006
10^3	0.02

$$h = 10 \text{ cm} \rightarrow \Delta t = 143 \text{ ms}$$

$$h = 1 \text{ mm} \rightarrow \Delta t = 14 \text{ ms}$$

\bar{H} Production via \bar{H}^+

Standard production

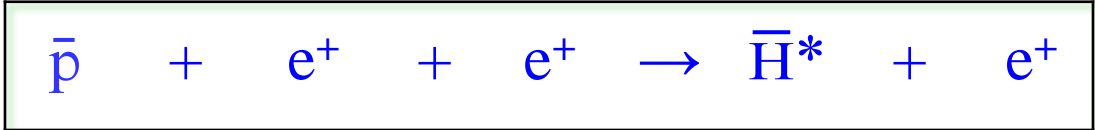

\bar{H}^+ Formation

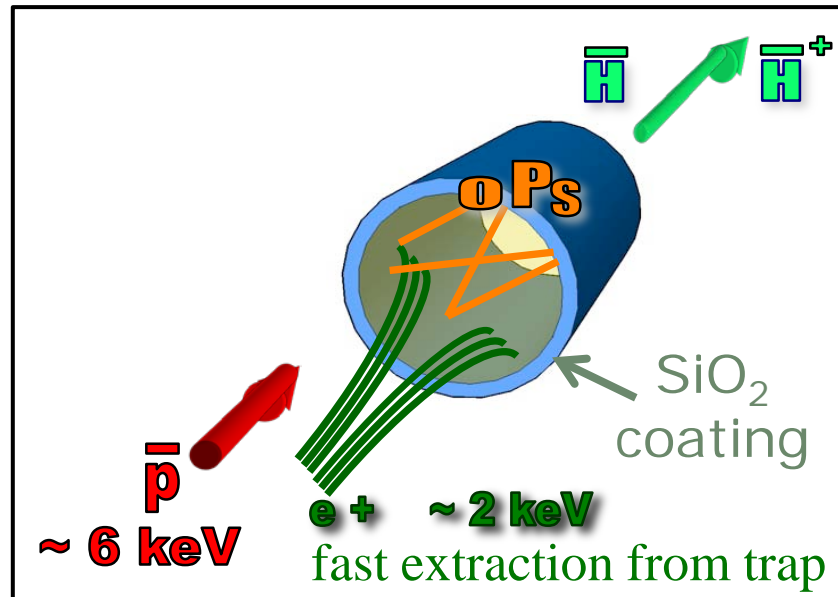
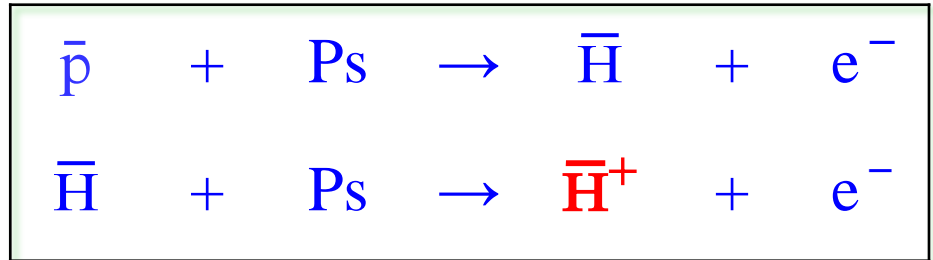

Cross-sections on Ps

J. P. Merrison et al., Phys. Rev. Lett. **78**, 2728 (1997)

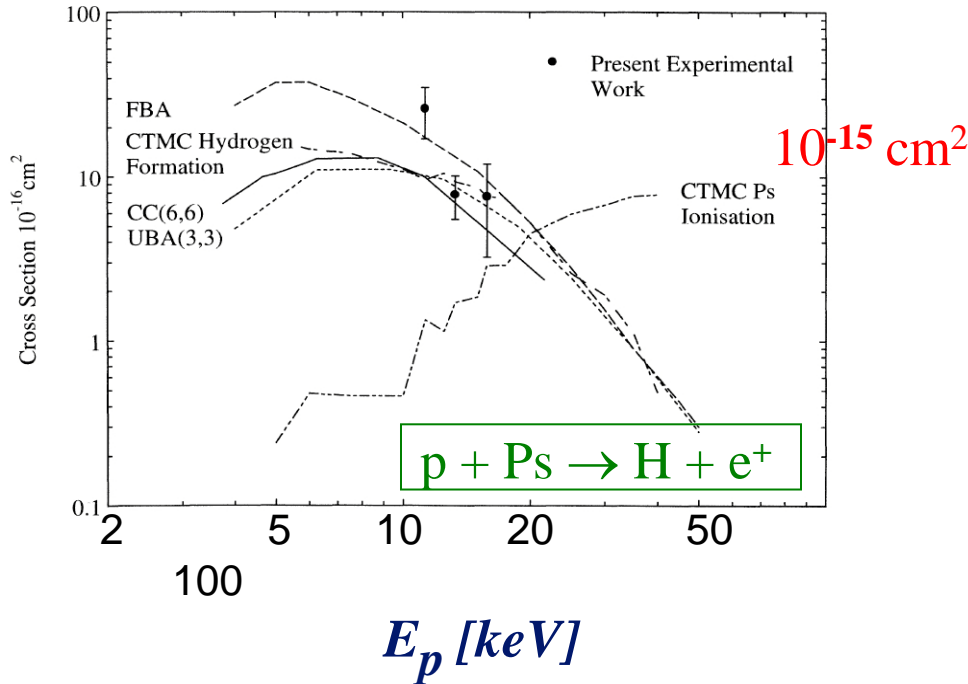

H.R.J. Walters and C. Starett, Phys. Stat. Sol. C, 1-8 (2007)

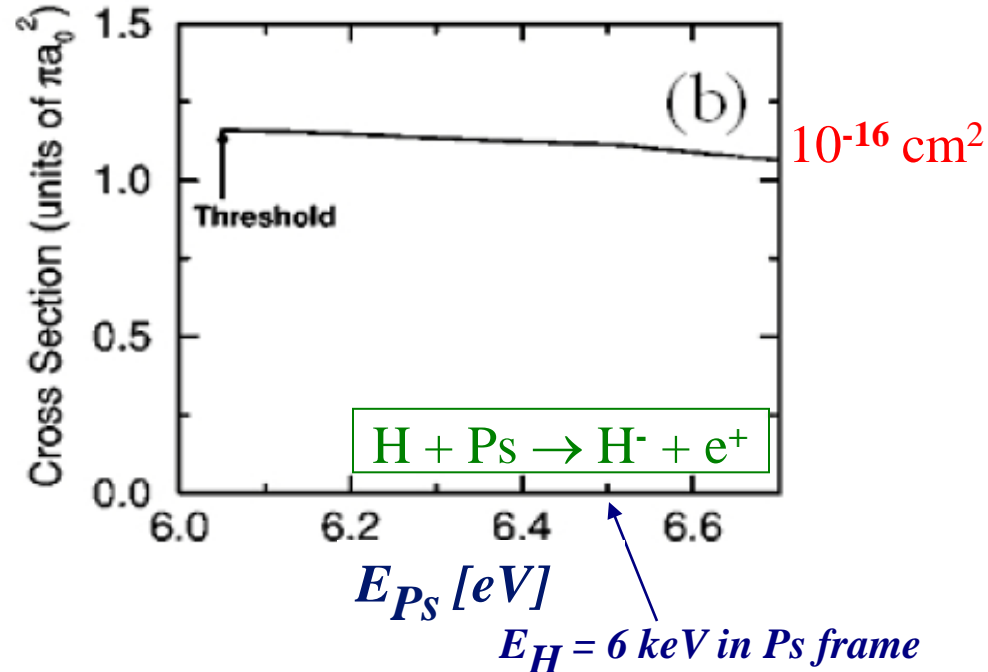

ASACUSA
every 20'

e^+ from
Linac & Trap



*if all Ps excited to $n=3$,
expect $\times 80$*

Synoptic Scheme

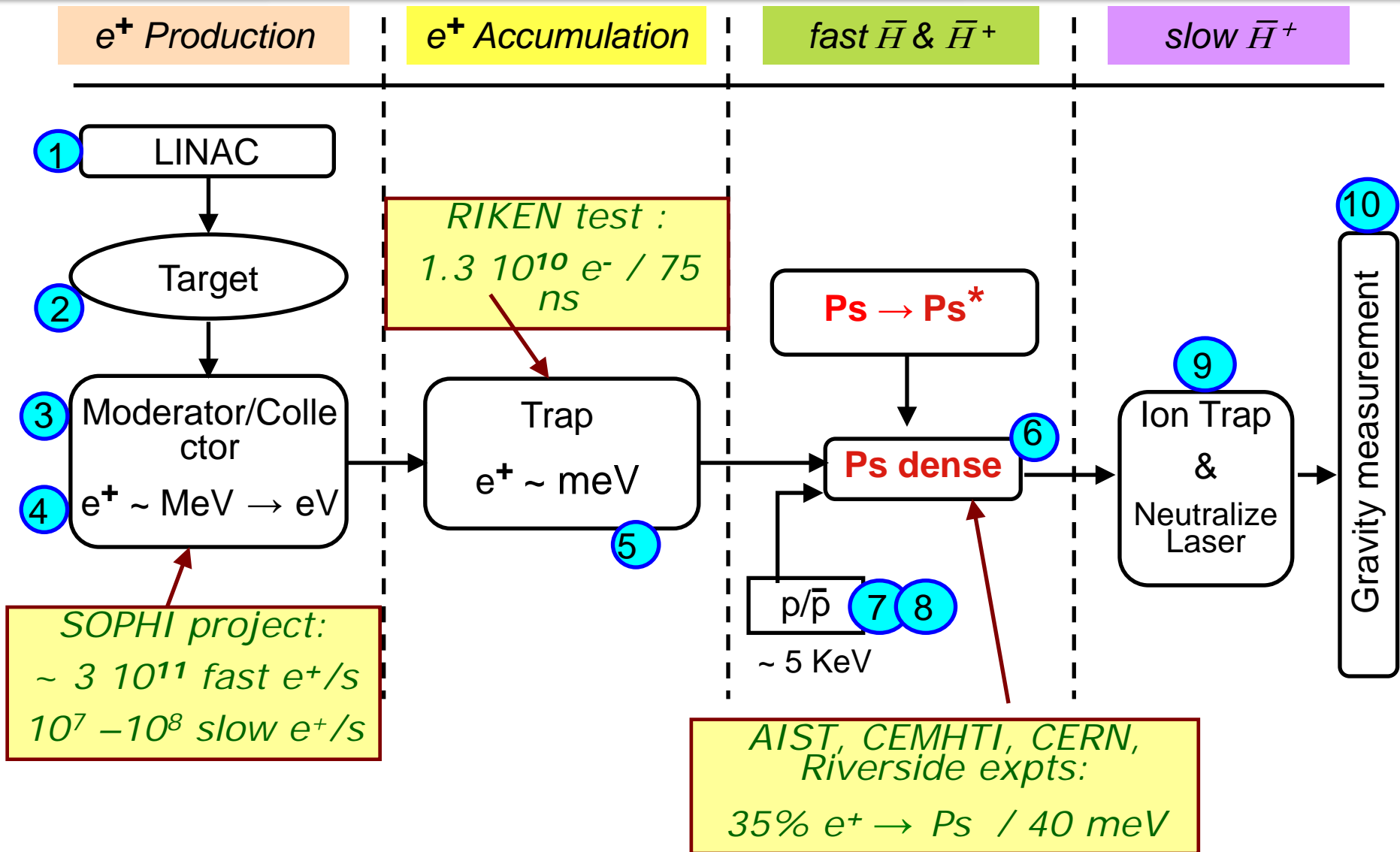

Efficiencies

Electrons						
Linac frequency (Hz)	Ie- (mA)	Ie- /pulse (mA)	pulse length (s)	Ne ⁻ / pulse	Ne ⁻ (s ⁻¹)	
200	1.40E-01	1.75E+02	4.00E-06	4.38E+12	8.75E+14	
Positrons						
ϵ (e ⁻ → e ⁺)	ϵ (transport)	ϵ (moderation)	Ne+fast / pulse	Ne+ fast (s ⁻¹)	Ne+ slow / pulse	Ne+ slow (s ⁻¹)
1.50E-04	0.8	1.00E-03	5.25E+08	1.05E+11	5.25E+05	1.05E+08
Positron Storage						
ϵ (trapping)	accum. time (s)	Ne+ stored				
0.2	1200	2.52E+10				
Positronium						
ϵ (e ⁺ → Ps)	volume tube (cm ³)	Ps density (cm ⁻²)	ϵ (excitation)			
0.35	0.01	8.82E+11	10			
\bar{H}						
N \bar{p} / pulse	$\sigma(\bar{p}+Ps \rightarrow \bar{H})$	$\sigma(\bar{H}+Ps \rightarrow \bar{H}^+)$	N \bar{H}	N\bar{H}^+		
1.00E+07	1.00E-15	1.00E-16	8.82E+04	7.78E+00		

↑
every 20 minutes pulse

Current Status / Aims

Electrons					
Linac frequency (Hz)	Ie- (mA)	Ie- /pulse (mA)	pulse length (s)	Ne ⁻ / pulse	Ne ⁻ (s ⁻¹)
200	1,40E-01	1,75E+02	4,00E-06	4,38E+12	8,75E+14
Positrons					
ε (e ⁻ → e ⁺)	ε (transport)	ε (moderation)	Ne+fast / pulse	Ne+ fast (s ⁻¹)	Ne+ slow / pulse
1,50E-04	0,8	1,00E-03	5,25E+08	1,05E+11	5,25E+05
Positron Storage					
ε (trapping)	accum. time (s)	Ne+ stored	10 ⁶ at RIKEN → 10 ¹⁰⁻¹¹ at Saclay		
0,2	1200	2,52E+10			
Positronium					
ε (e ⁺ → Ps)	volume tube (cm ³)	Ps density (cm ⁻²)	ε (excitation)		
0,35	0,01	8,82E+11	10		
\bar{H}					
N \bar{p} / pulse	σ(\bar{p} +Ps → \bar{H})	σ(\bar{H} +Ps → \bar{H}^+)	N \bar{H}	N \bar{H}^+	
1,00E+07	1,00E-15	1,00E-16	8,82E+04	7,78E+00	

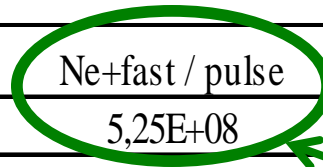
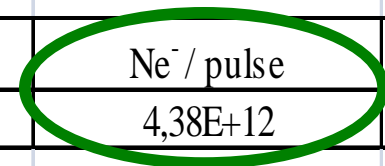

1/4

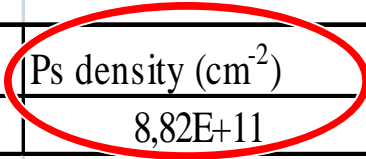
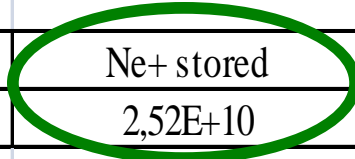

Installation at Saclay (Nov'08 – May'09)

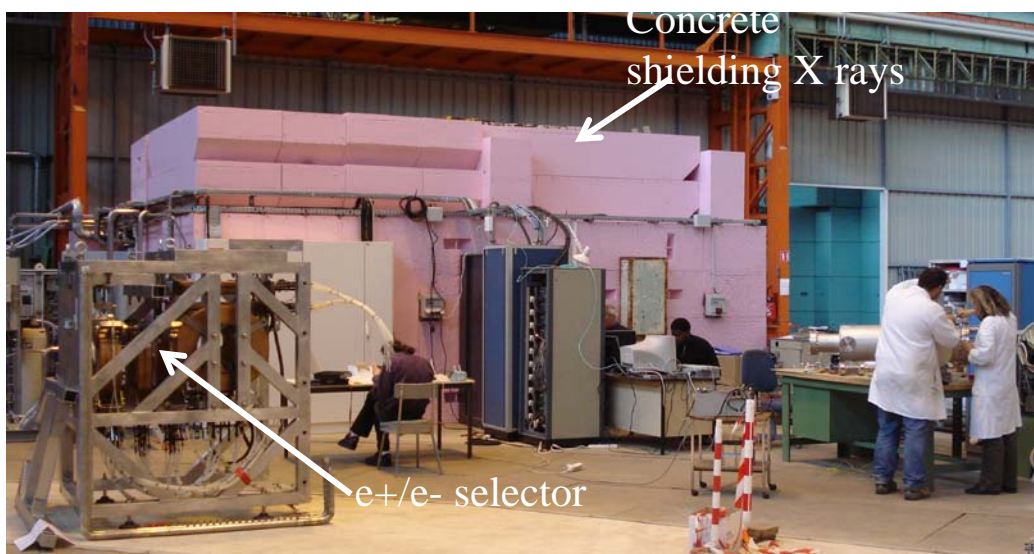

Funding CEA-CG Essonne



*ANR
2006*

Demonstrator e⁻ Linac
 $E_c = 5.5 \text{ MeV}$
 $I_{\text{measured}} = 0.14 \text{ mA}$

e^+/e^- selector

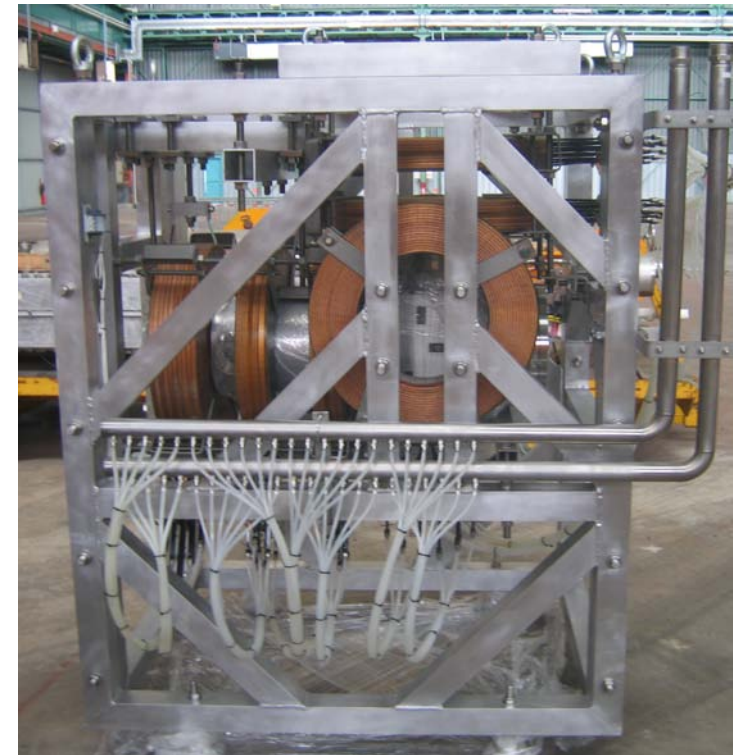
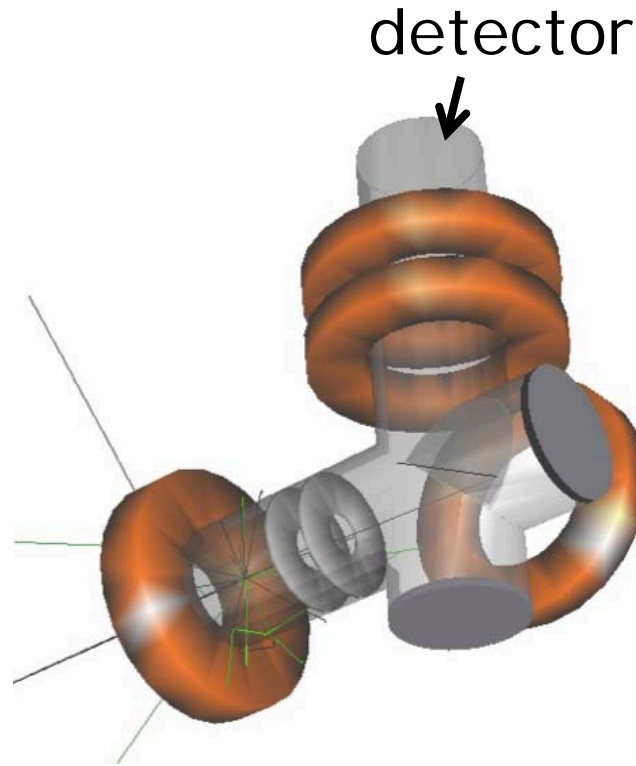
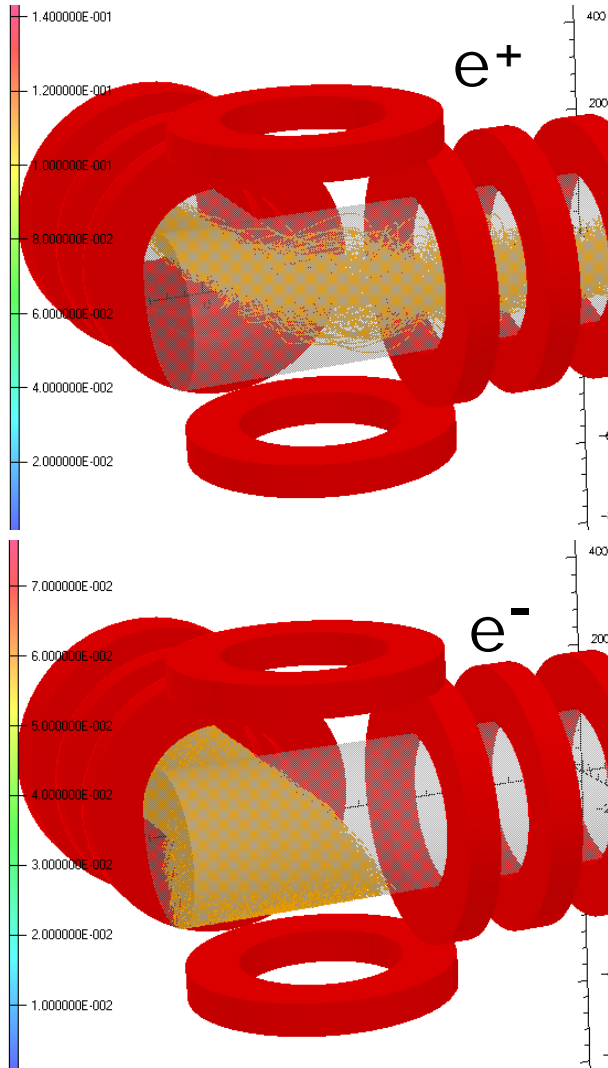

Fast e^+ detection

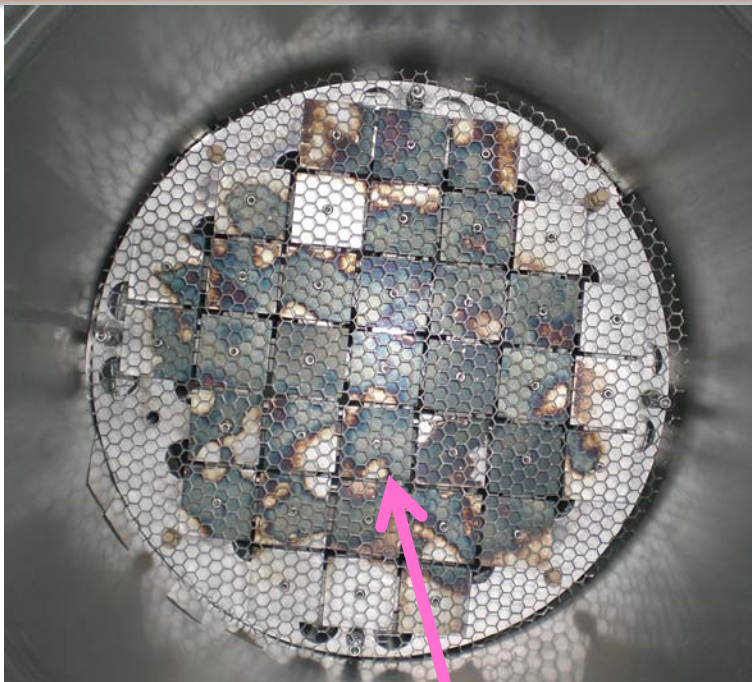

35 Faraday cups

Expected e^+ yield from 1 mm W target
at 5.5 MeV $\sim 1 \cdot 10^{-4}$ per e^-

Linac peak current $\sim .12$ mA during $4 \mu\text{s}$

GEANT4 simulation: 1 mm target

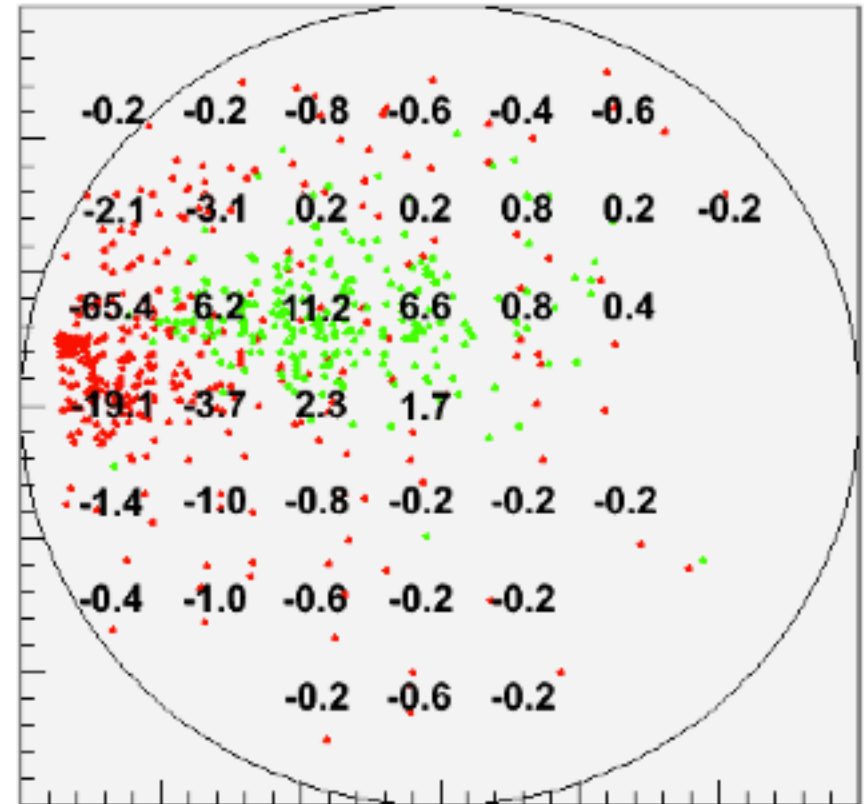

e^- e^+

Fast e^+ detection

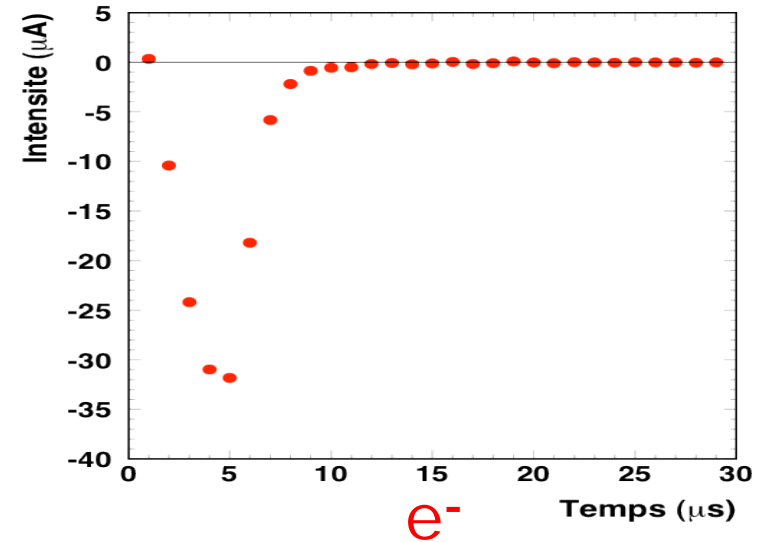
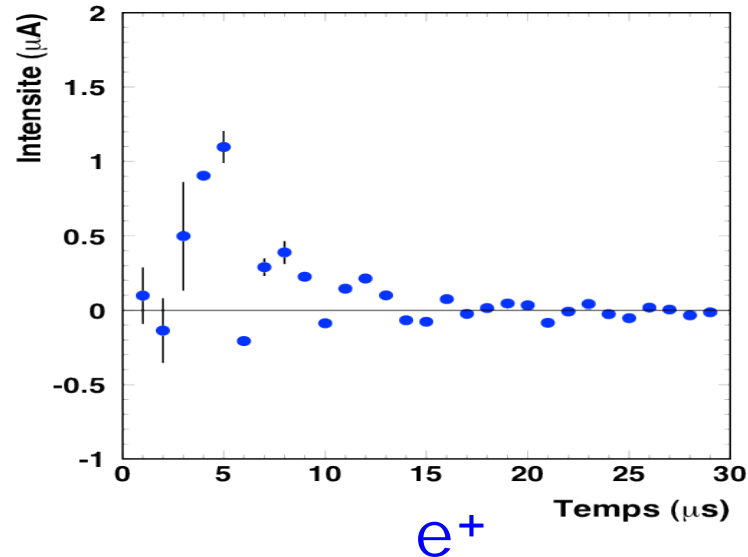

Expected e^+ charge on pads 11-12
~ 18 pC per burst
charge seen ~ 4 pC per burst

electron additional background ?
LINAC energy < 5.5 MeV ?

Synoptic Scheme

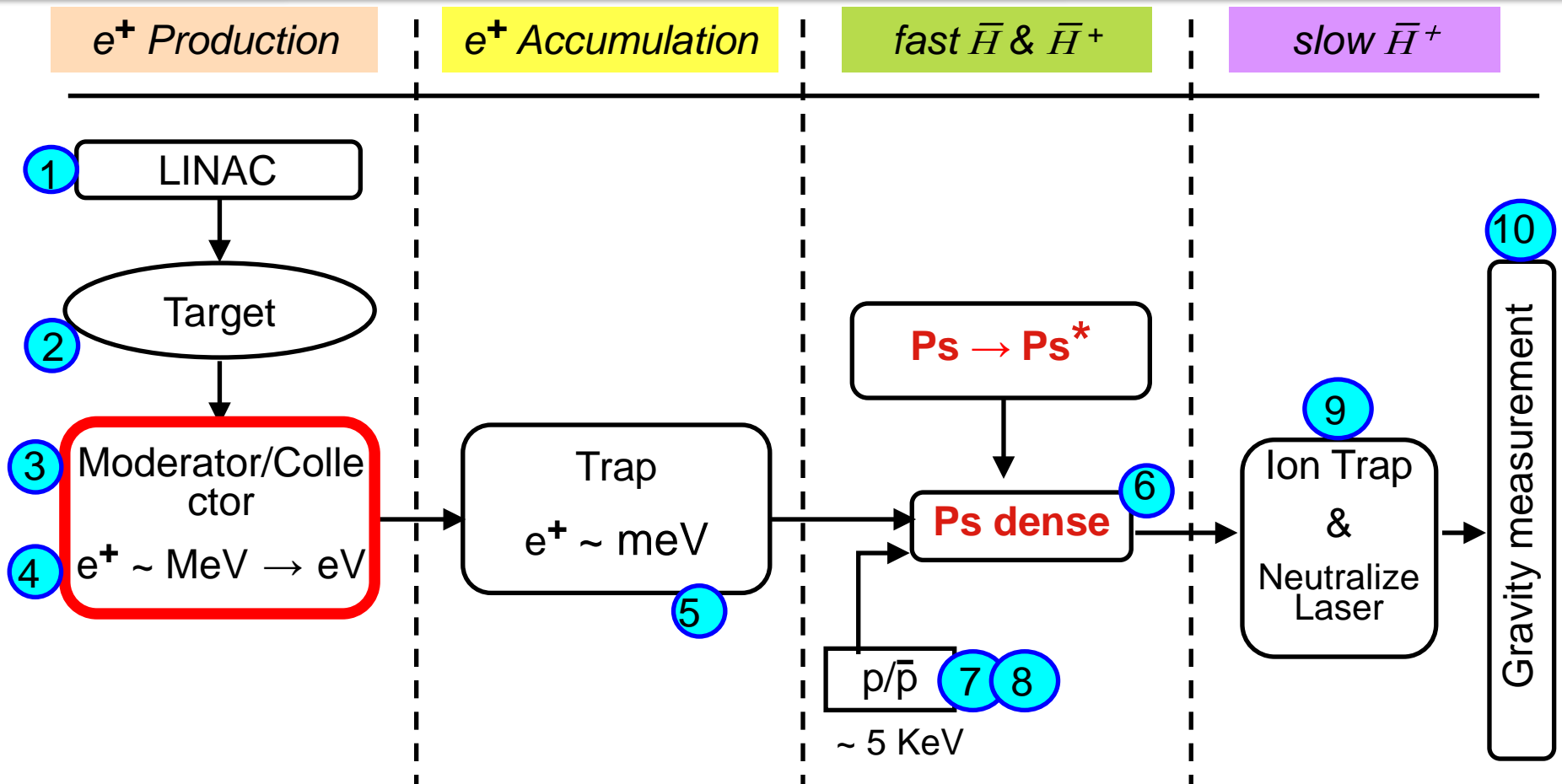

Production and extraction of slow positrons

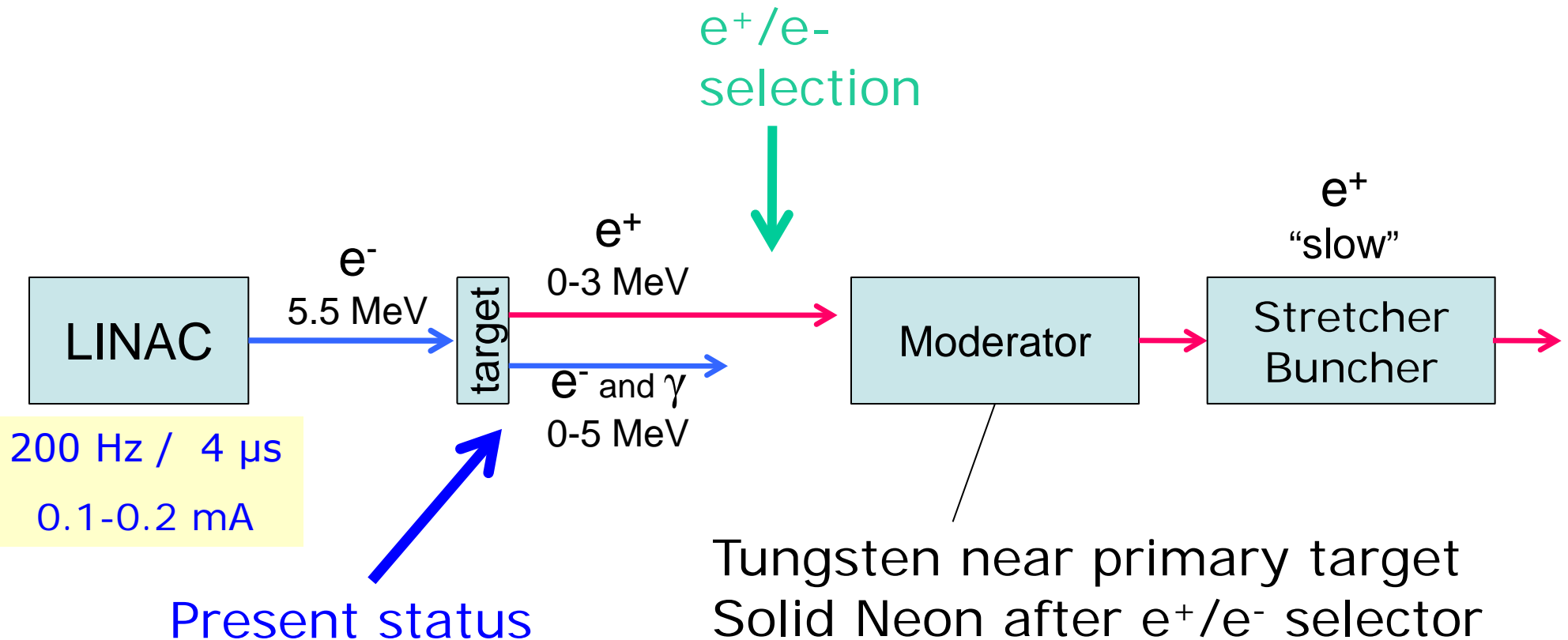

2-3 beam lines

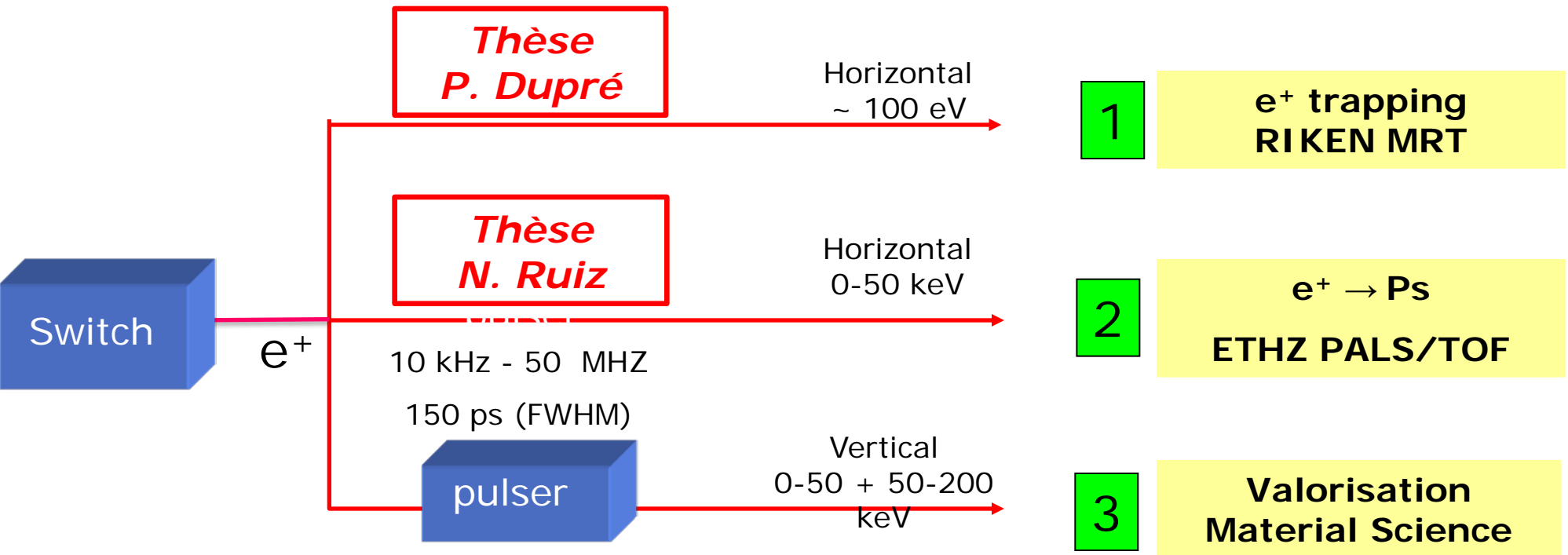

Line 2 also suitable for fundamental research:

- Axions $\text{Ps} \rightarrow a + \gamma$
- Mirror Universe $\text{Ps} \rightarrow \text{invisible}$
- Excitation $\text{Ps} \rightarrow \text{Ps}^*$

Synoptic Scheme

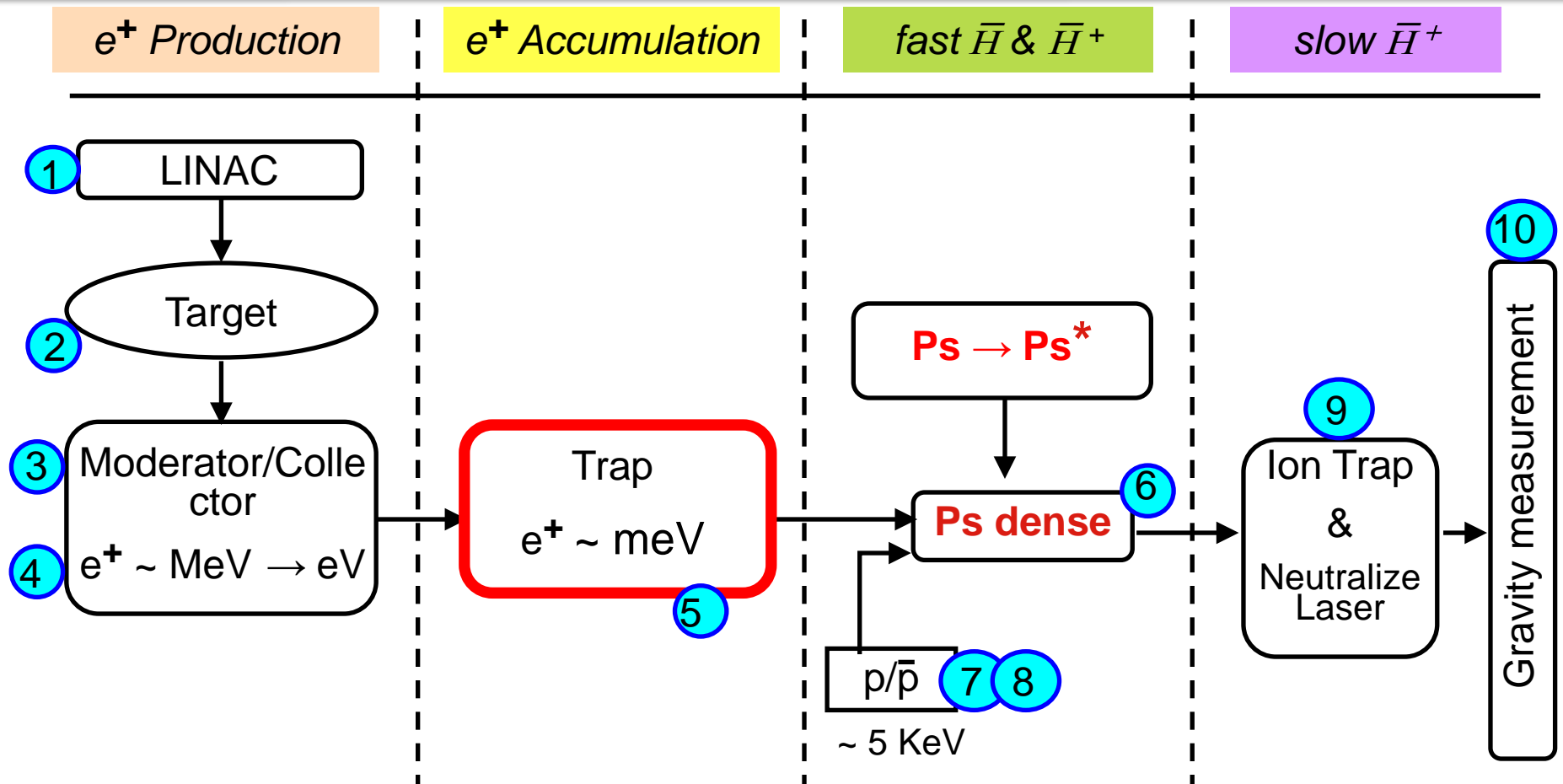

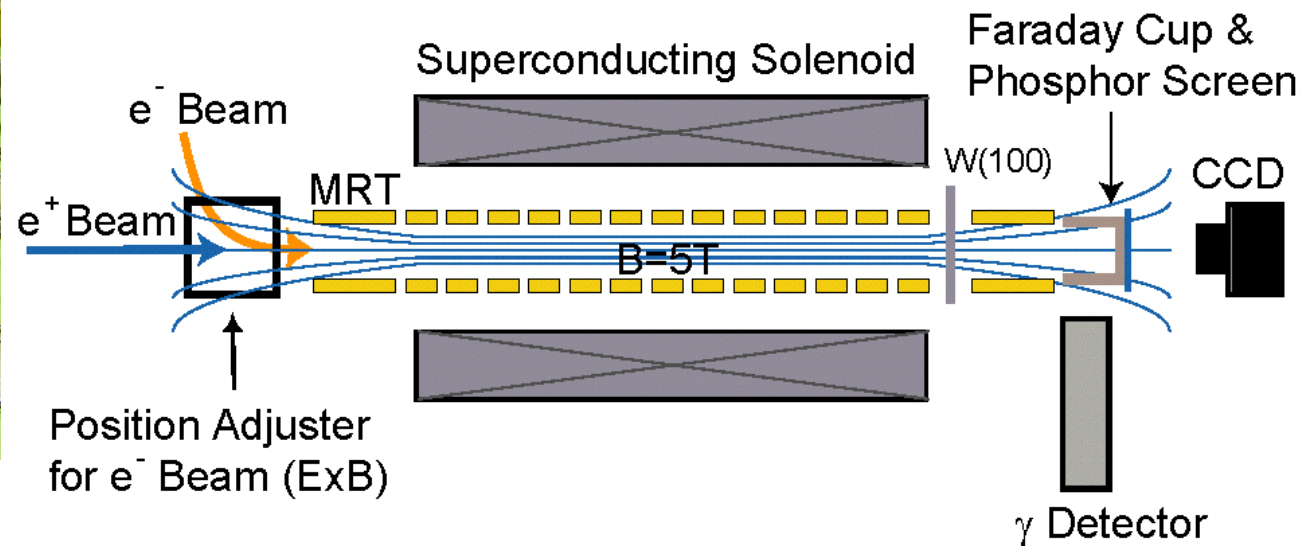
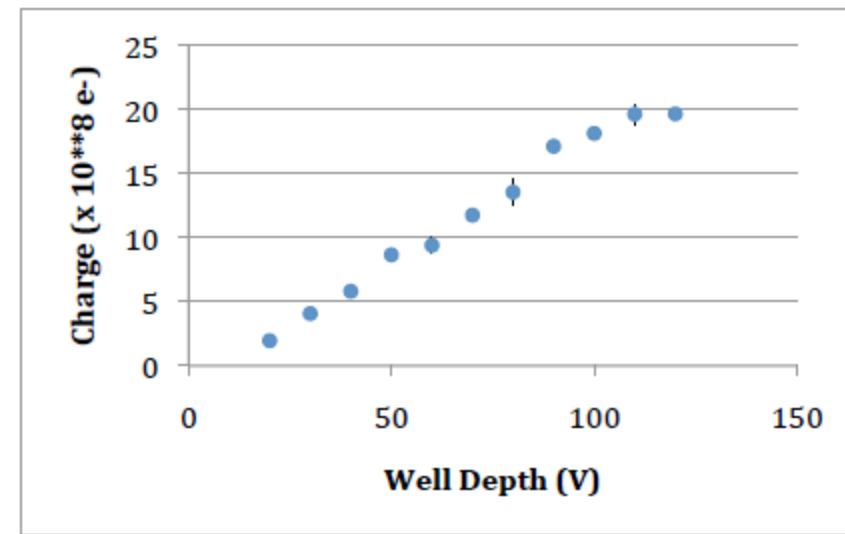
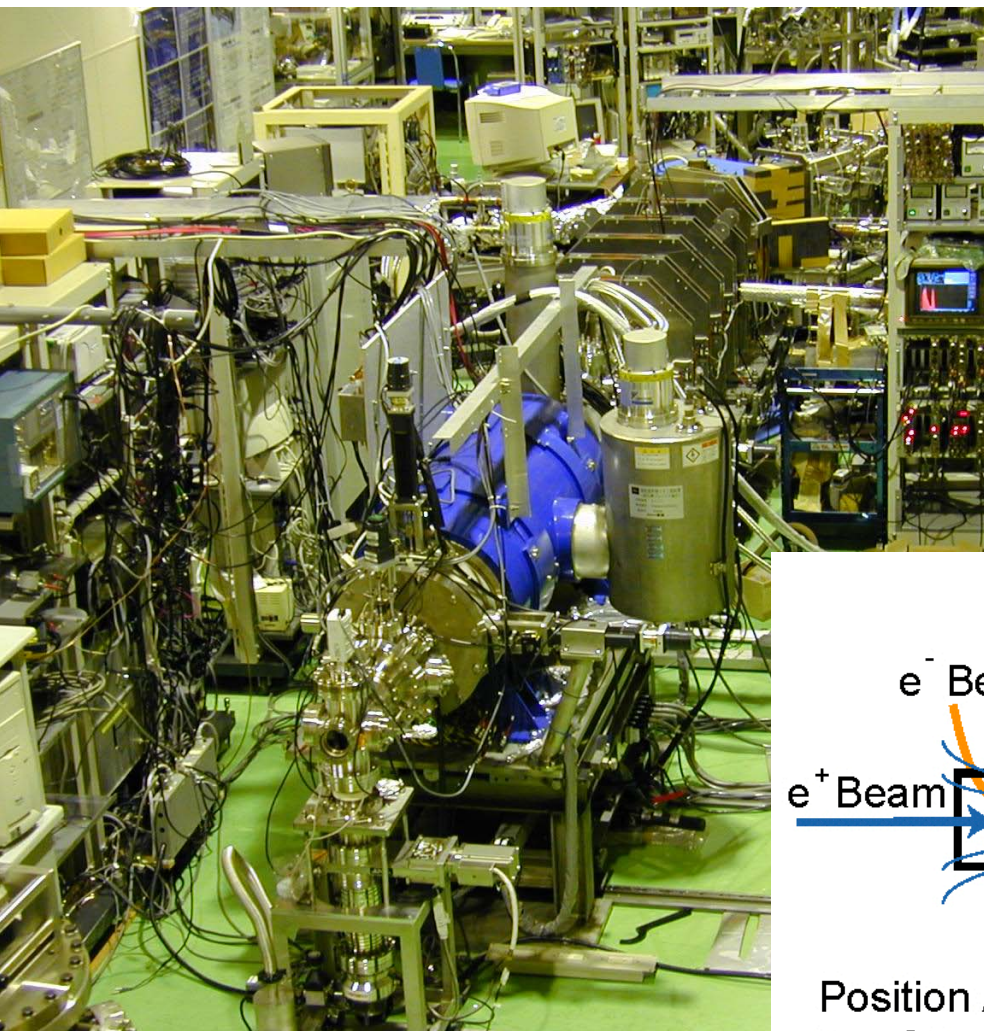

RIKEN trapping mechanism

Stopping power of an electron plasma, $n=10^{17} \text{ m}^{-3}$

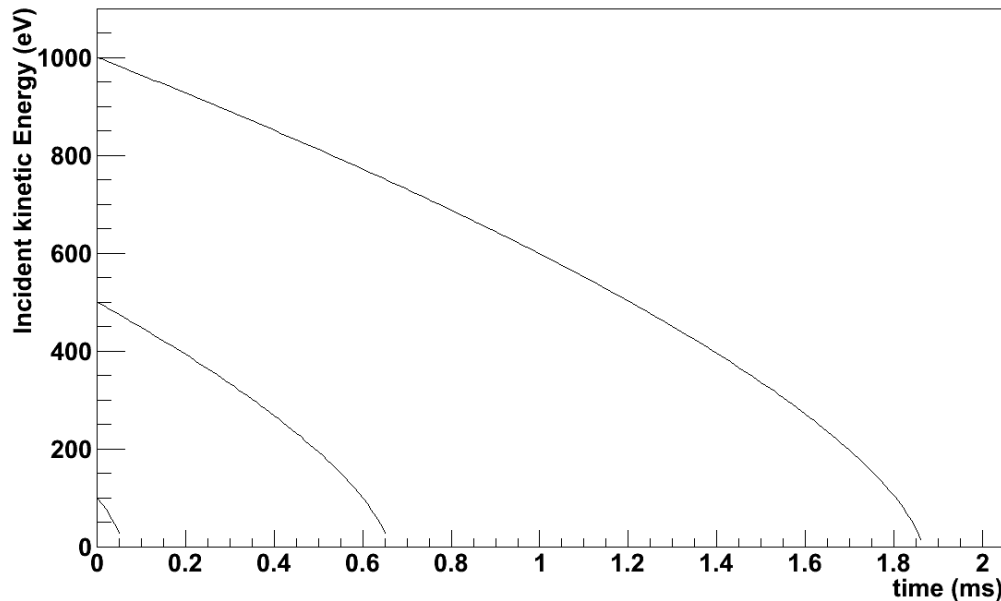

a) e^- Plasma Formation

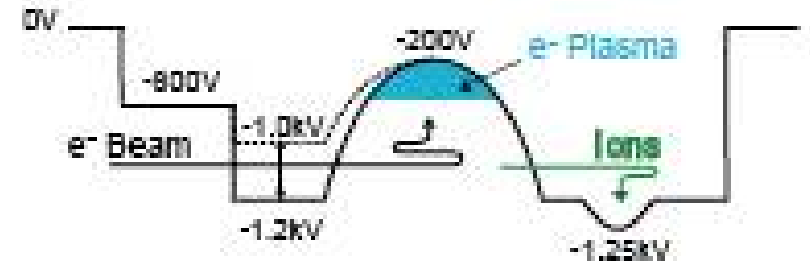

b) e^+ Trapping

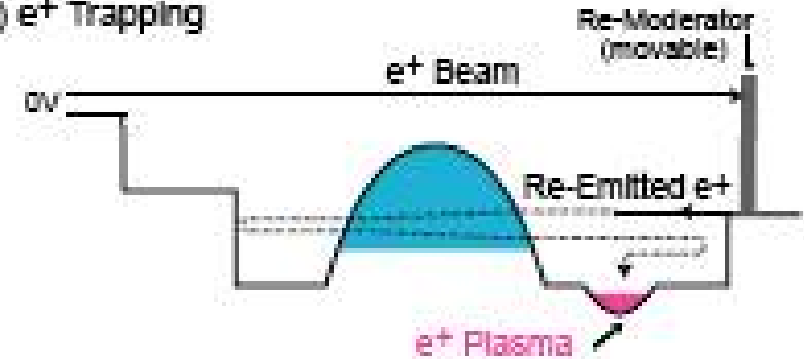

Cooling by e^- plasma

Ne^+ stored: 10^6 already obtained , 10^{10-11} needed

Synoptic Scheme

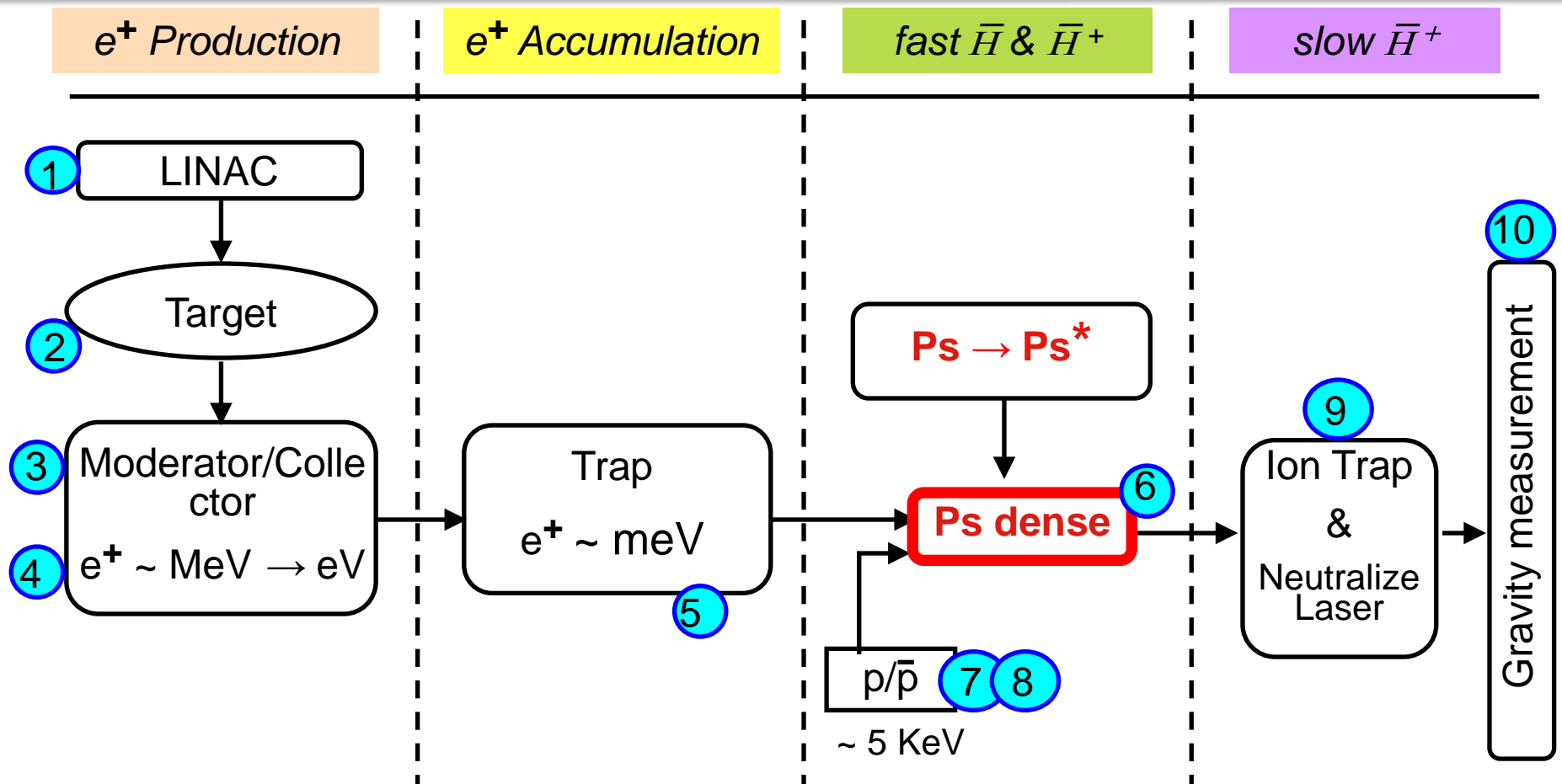

Slow e^+ beams: PALS/TOF

*AIST Tsukuba
(R. Suzuki, T. Ohdaira)*

*E.T.H Zurich (A. Rubbia, U. Gendotti, P. Crivelli)
IRFU Saclay (P. Pérez, L. Liszkay)*

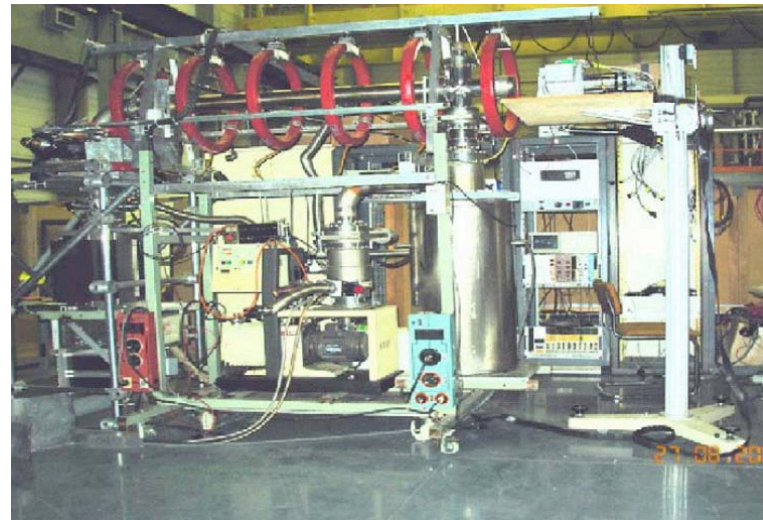
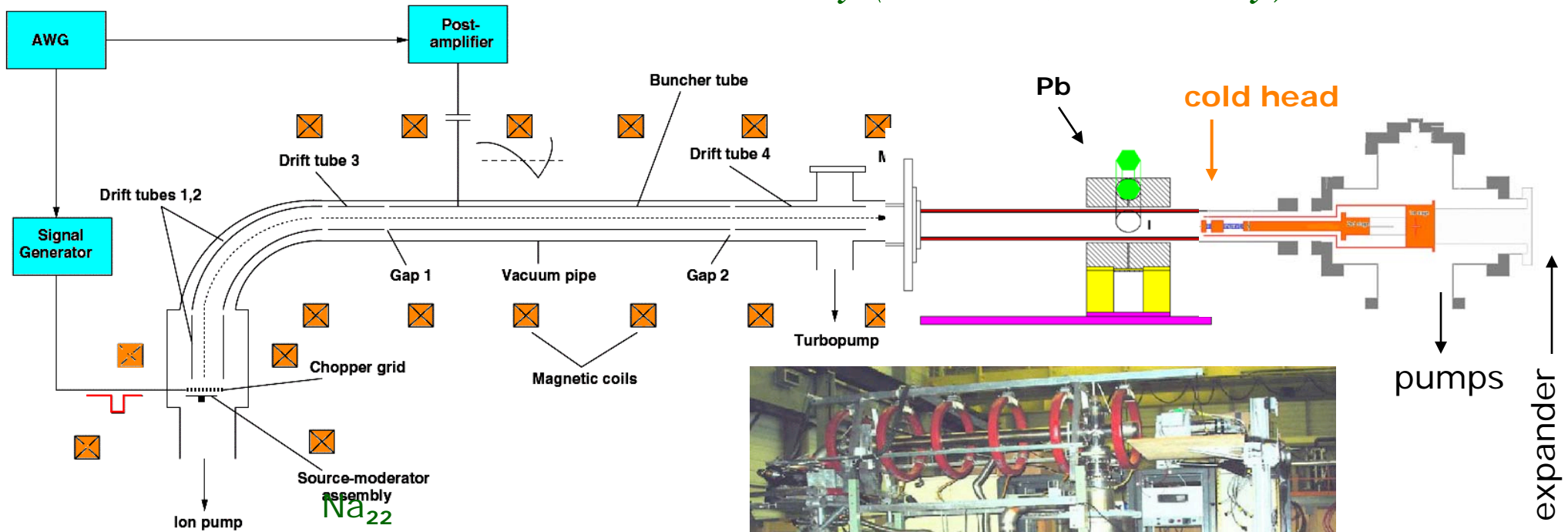

N. Alberola et al., Nucl. Instr. Meth. A 560 (2006) 524.

*CEMHTI Orleans
(M.F. Barthe)*

The CEA-ETHZ slow e^+ beam based Ps spectrometer at CERN

ortho-positronium lifetime spectrometer
(precise detection of emitted o-Ps)

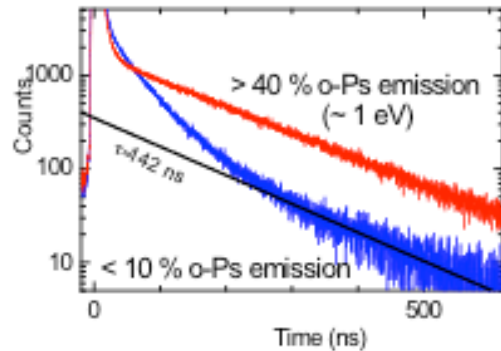

ortho-positronium time-of-flight (TOF) spectrometer

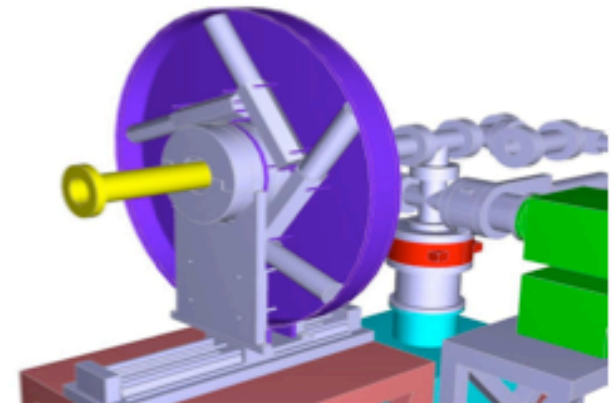
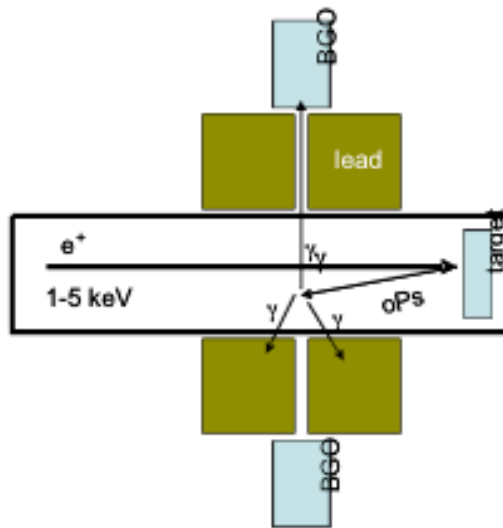
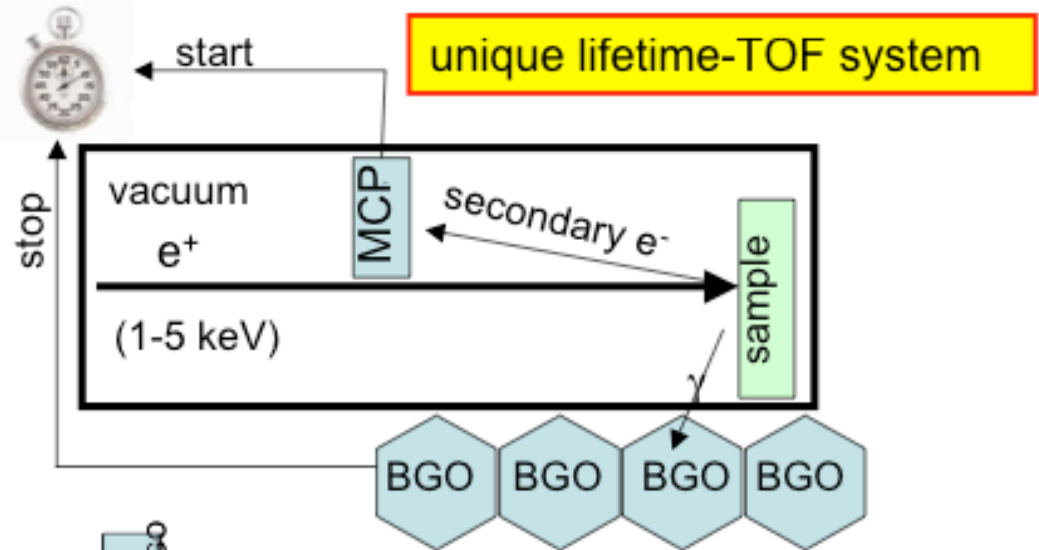
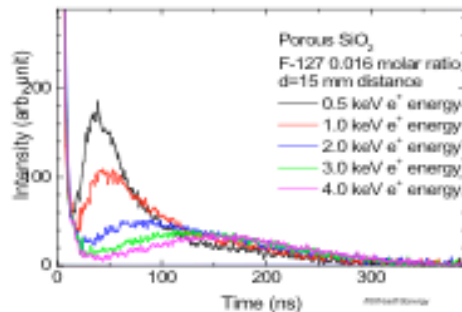

Emission o -Ps from single shot lifetime

PHYSICAL REVIEW A 81, 012715 (2010)

Positronium cooling in porous silica measured via Doppler spectroscopy

D. B. Cassidy,¹ P. Crivelli,² T. H. Hisakado,¹ L. Liskay,^{3,*} V. E. Meligne,¹ P. Perez,³ H. W. K. Tom,¹ and A. P. Mills Jr.¹

¹Department of Physics and Astronomy, University of California, Riverside, California 92521-0413, USA

²URFJ, Rio de Janeiro, Brazil

³CEA, Saclay, IRFU, F-91191 Gif-sur-Yvette Cedex, France

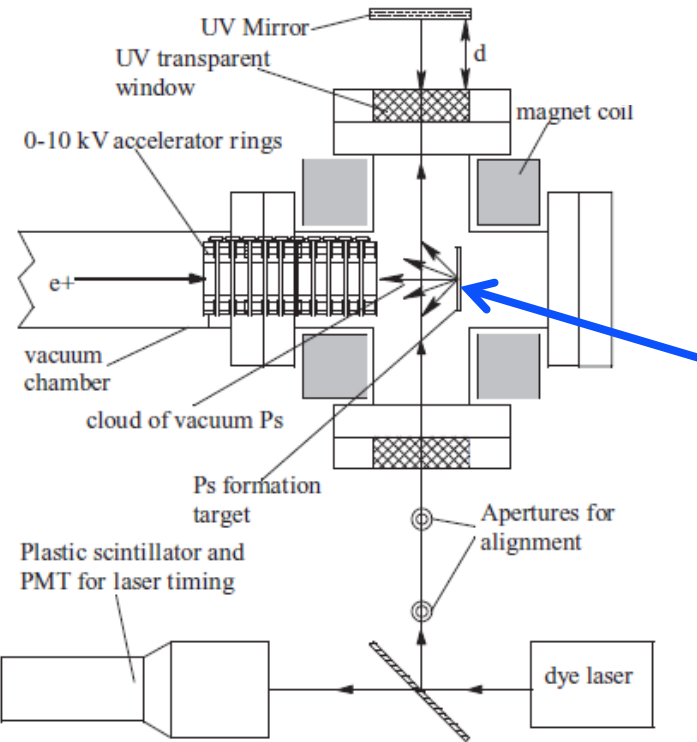

**Sample
from Saclay**

Laser : 243.5 nm
< 350 μ J/pulse

Experimental setup (UCR)

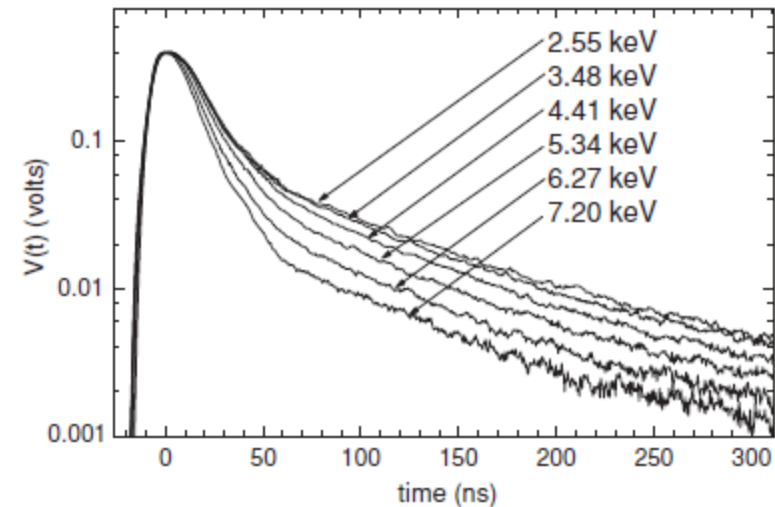

Data analysis : delayed fraction

$$f_d = \frac{\int_{50\text{ns}}^{300\text{ns}} V(t)dt}{\int_{-50\text{ns}}^{300\text{ns}} V(t)dt}$$

Yield of *o*-Ps : comparison CERN/UCR

Measurement
at CERN

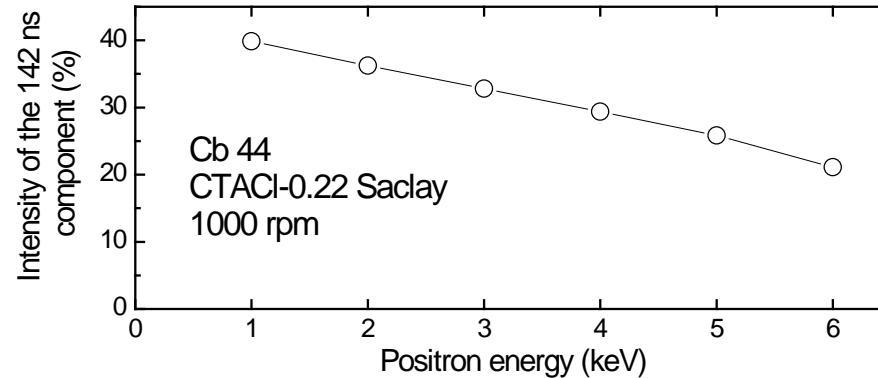

$$\sim 3.5 \times 10^5 \text{ e}^+ \text{ cm}^{-2}\text{s}^{-1}$$

$$\text{e}^+ \text{ flux} \\ \times \\ \sim 10^{11}$$

$$\sim 5.6 \times 10^{16} \text{ e}^+ \text{ cm}^{-2}\text{s}^{-1}$$

Measurement
at UCR

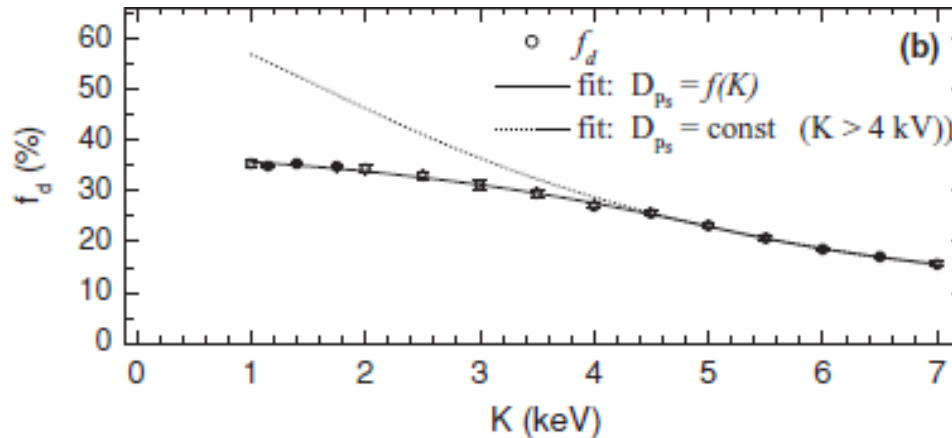

No loss in conversion efficiency in spite of the 10^{11} intensity factor

Energy of *o*-Ps : comparison CERN/UCR

CERN →

P. Crivelli et al., Phys. Rev. A **81**, 052703 (2010).

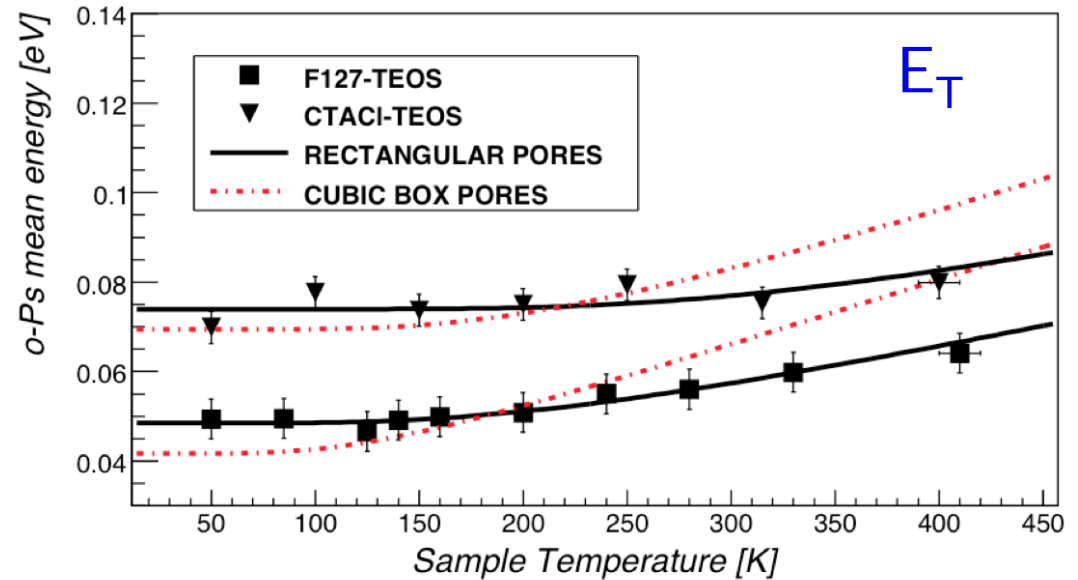

UCR →

D. B.. Cassidy et al., Phys. Rev. A **81**, 012715 (2010).

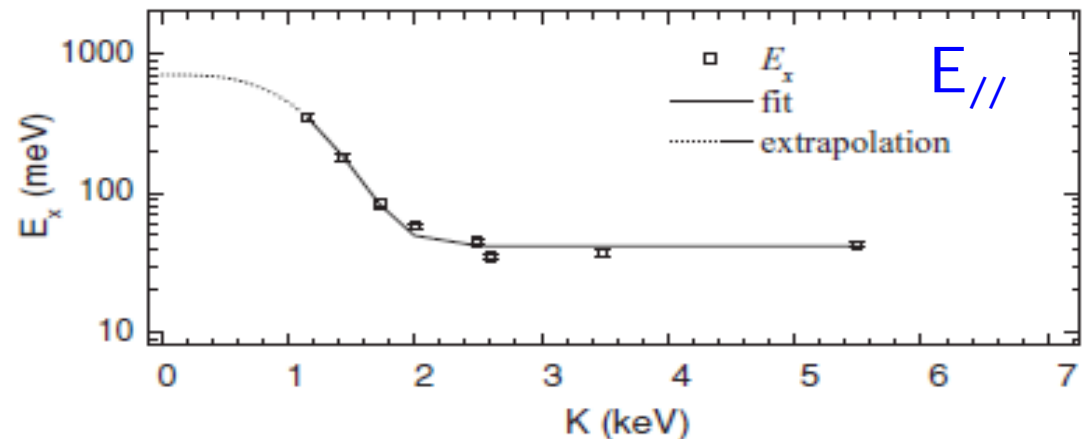

Dernières étapes franchies

- 2010
- Conception de la ligne de transport des positons lents, début de la construction (Hall 126)

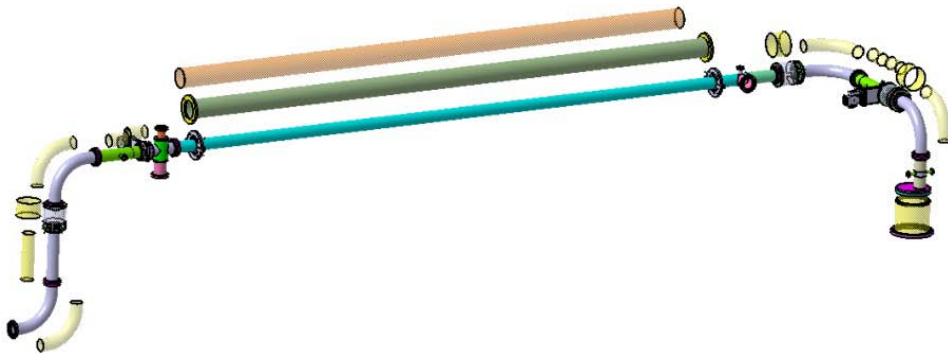
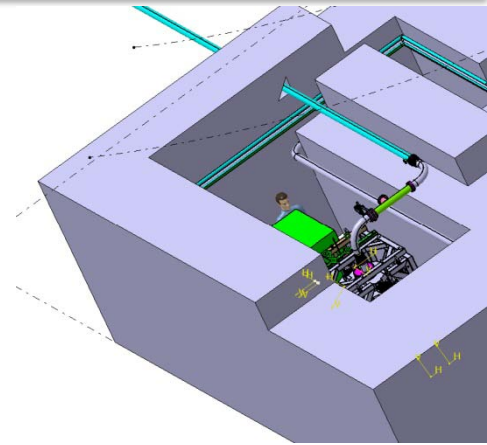

Dernières étapes franchies (2)

- 2010
- **Transfert du piège de RIKEN à Saclay: démontage en décembre, arrivée janvier 2011**
(ANR POSITRAP : IRFU-CSNSM-IPCMS UDS-RIKEN-SWANSEA)



Dernières étapes franchises (3)



2010

- Formalisation de la collaboration:

Gravitational
Behaviour of
Antihydrogen at
Rest

Proposal en cours de rédaction:
dépôt mars 2011 (date cible...)
Approval au SPSC de juin?



ELENA (Extra Low ENergy Antiproton ring)

- ❑ **Nouvel anneau** en projet pour décélérer encore un peu plus les antiprotons de l'AD, avec des pertes minimales. Situé à l'intérieur de l'AD
- ❑ **AD:**
 - \bar{p} 5,5MeV, 1 ligne à la fois pendant 6, 12, 24h...
- ❑ **ELENA:**
 - \bar{p} 100 KeV , possibilité de distribuer plusieurs lignes
 - Nouvelle ligne possible
- ❑ **Décision Cern en 2011?**

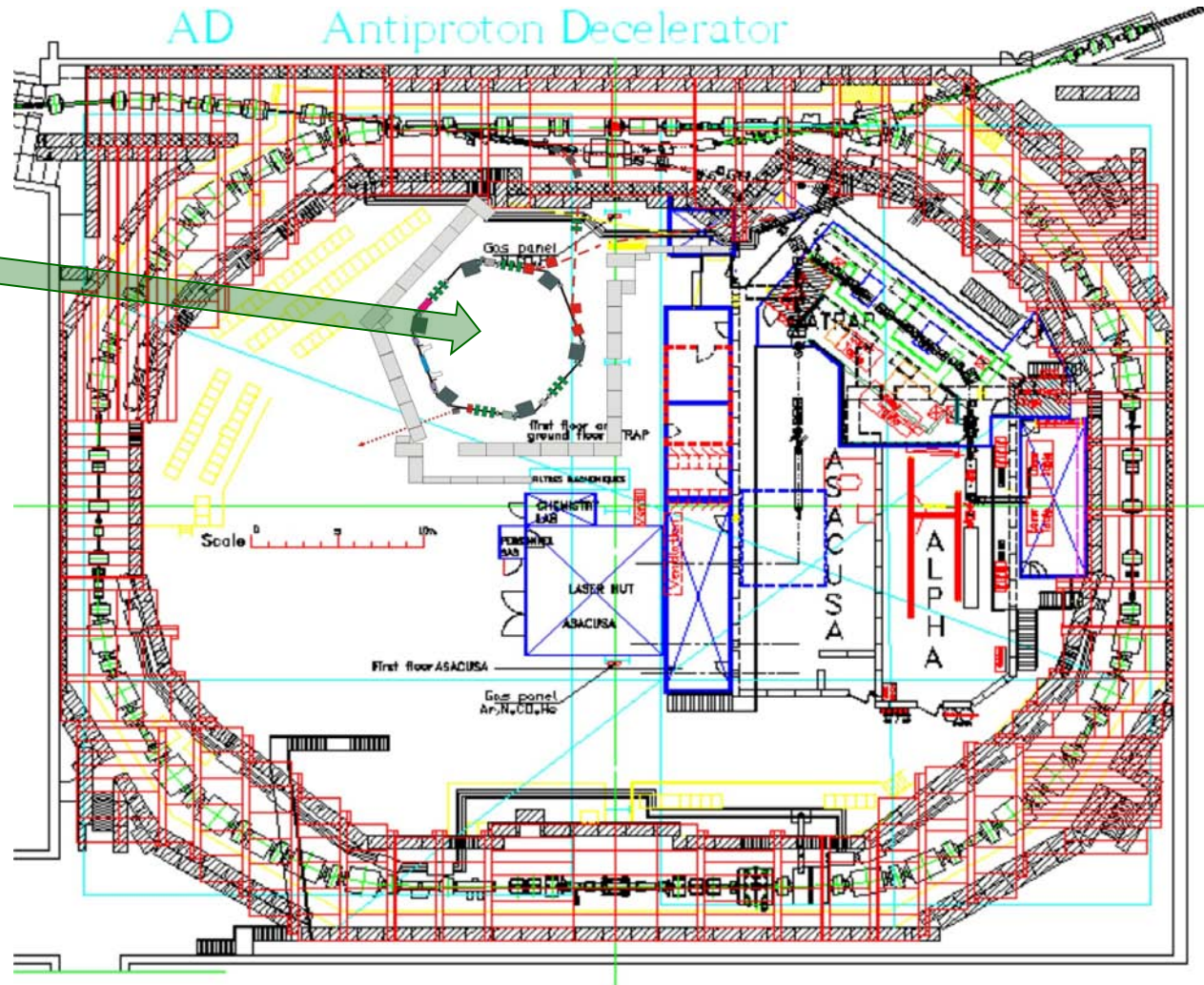

A venir

2011-2012

- Proposal CERN
 - Modération des positons, transport jusqu'au piège
 - Installation du piège de RIKEN
 - Piégeage des positons lents produits par le linac
 - Optimisation de la production de positronium (linac, modérateur)
- ? Décision sur ELENA

2012-1013

- Excitation du positronium
- Conception du piège à \bar{H}^+
- Dispositif de *photodetachment*
- Conception du dispositif de mesure de chute.

2014

- Let's go to CERN

Spin-off

- ❑ **Proposition EQUIPEX: projet PAM**

Positrons et Positronium pour l'Antihydrogène et les Matériaux

Plate-forme d'analyse utilisant une source intense de positons.

Problems in Atomic Physics

- Ps^* to increase $\bar{p} + Ps^* \rightarrow \bar{H}^* + e^-$ and $\bar{H}^* + Ps^* \rightarrow \bar{H}^+ + e^-$
 - $\sigma \propto n^4$
 - $E(Ps, n = 3) \approx 0.75 \text{ eV} \approx E(\bar{H}^+)$
- Sympathetic cooling of \bar{H}^+ with ions, laser cooling ? $\rightarrow 100 \mu\text{K}$
- Photo detachment with minimal recoils

Photo detachment with minimal recoils

- $100 \mu\text{K} \Leftrightarrow 1.6 \text{ m/s} \Leftrightarrow mgh = 13 \text{ cm} \Leftrightarrow 0.14 \text{ s}$ (if $g = \bar{g}$)
 - photon absorption \rightarrow small effect in horizontal plane
 - e^+ recoil: 0.5 meV above threshold $\Leftrightarrow \sigma = 4 \cdot 10^{-21} \text{ cm}^{-2}$
 - 10 mW laser
 - $10 \bar{\text{H}}^+ \text{ mm}^{-2}$
 - 1 ms / 2 Hz
 - laser polarization ?
- } $\sim 1 \text{ evt} / 20 \text{ min}$

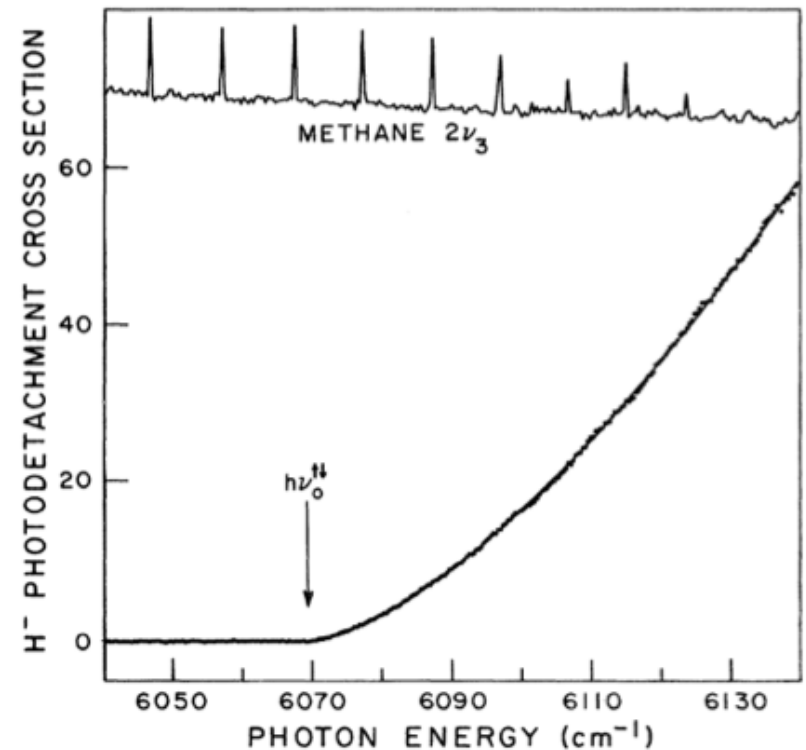

K. R. Lykke, K.K. Murray, W.C. Lineberger, Phys. Rev. A **43**, 6104 (1991).

Competition : AEGIS

- Scheme “orthogonal” to ours:
 - We send keV \bar{p} into a neutral Ps cloud “at rest”
 - They send meV Ps* onto charged \bar{p} “at rest”
- We need lots of e^+ and keep efficiencies at high level all along!
- They must prepare very cold \bar{p} (100 mK: evaporative cooling applicable \rightarrow loss of \bar{p})
- etc...

