

The ATLAS Liquid Argon EM calorimeter, its performance and role in $H \rightarrow \gamma\gamma$ studies

G.Unal (CERN)
IRFU Seminar - 8 April 2019

ATLAS : General purpose detector at the CERN LHC (design: pp collisions at $\sqrt{s}=14$ TeV and $L\sim 10^{34}\text{cm}^{-2}\text{s}^{-1}$)

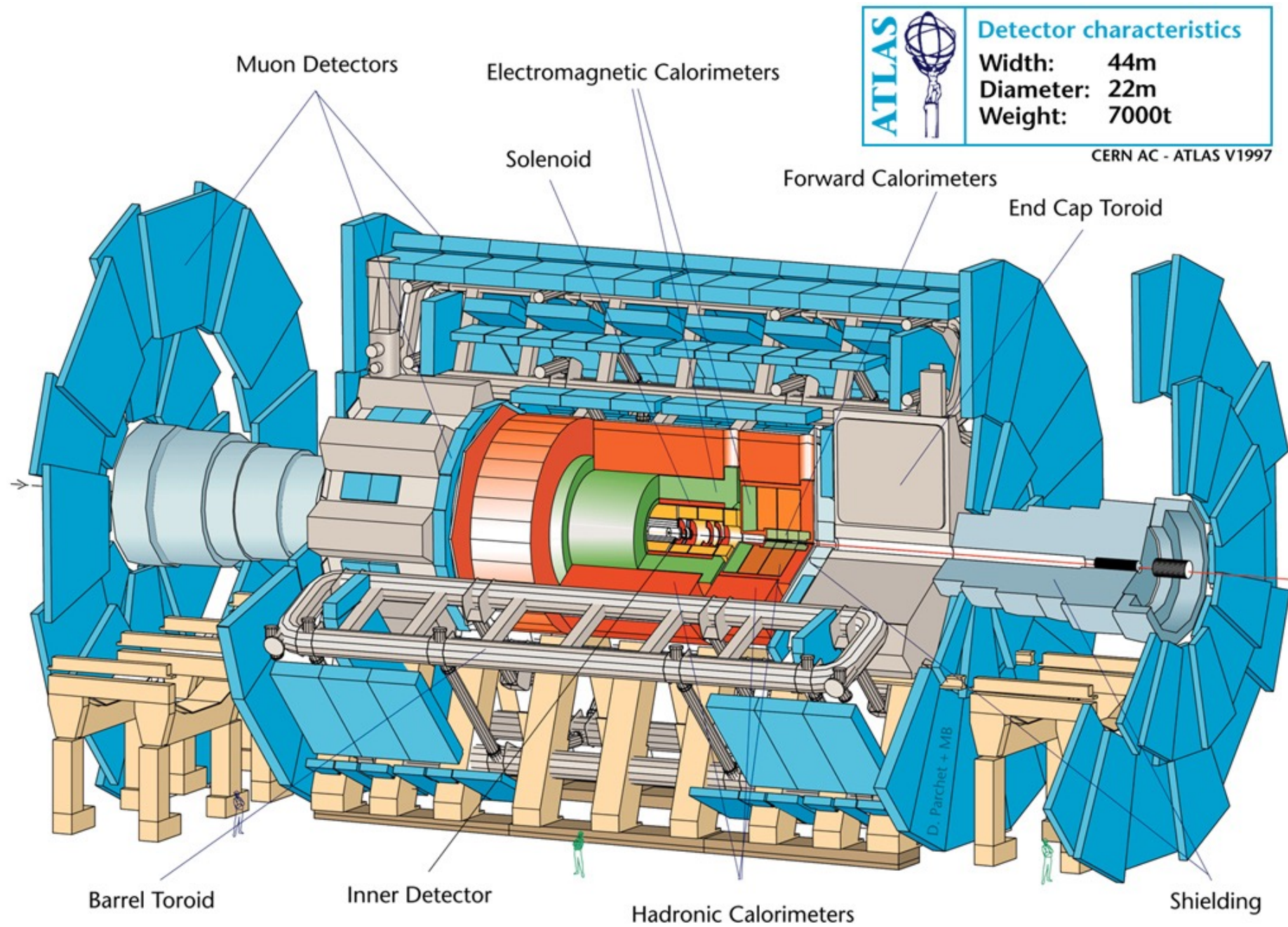

Requirements for EM calorimeter were mostly driven by low mass Higgs boson search:

- Sustain LHC conditions (radiations, etc..)
- Work at design luminosity of $10^{34} \text{ cm}^{-2} \text{ s}^{-1}$ (25 interactions per bunch crossing)
 - Interaction rate $\sim 1 \text{ GHz}$ with 40 MHz bunch crossing rate
 - $\sim 100 \text{ kHz}$ L1 trigger rate
- High granularity to reduce pileup effect and provide good electron and photon identification
 - *Including photon/ π^0 separation to reduce background to $H \rightarrow \gamma\gamma$*
- Fast readout to reduce pileup effect (especially on energy resolution)
- Good enough energy resolution to achieve good mass resolution and sensitivity to $H \rightarrow \gamma\gamma$
 - *Completed by pointing resolution to have robust mass resolution at high pileup*
 - *Sampling term of $\sim 10\%/\sqrt{E}$ found adequate*

ATLAS LAr calorimeter

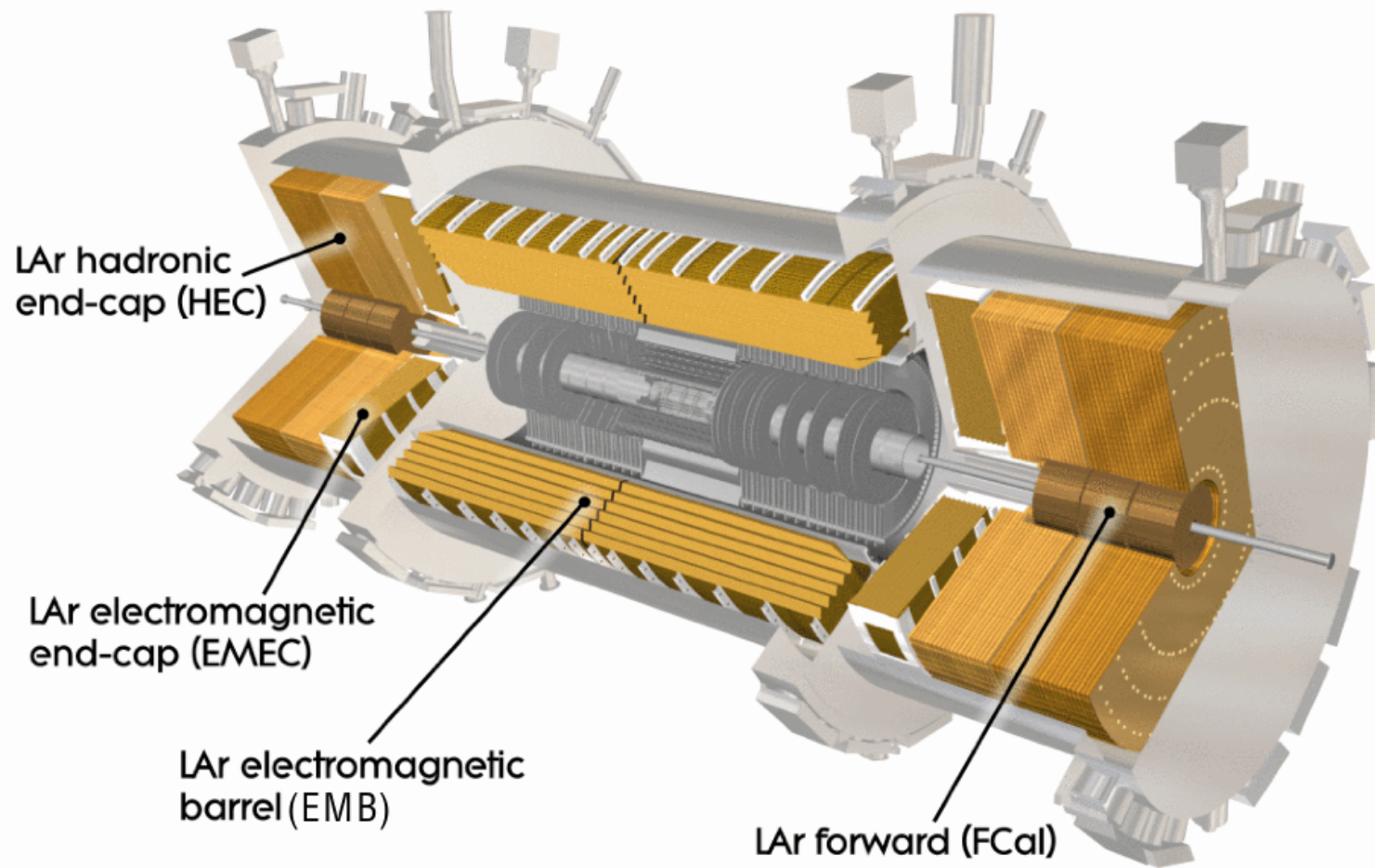

EM calo: Pb+LAr, accordion geometry
 EM Barrel: ± 1.45 in eta
 EM EndCap (1.37-3.2 in eta): 1.5-2.4 with high granularity in layer 1
 182468 channels (173312 in EM calo, 0.2% non operational during data taking)

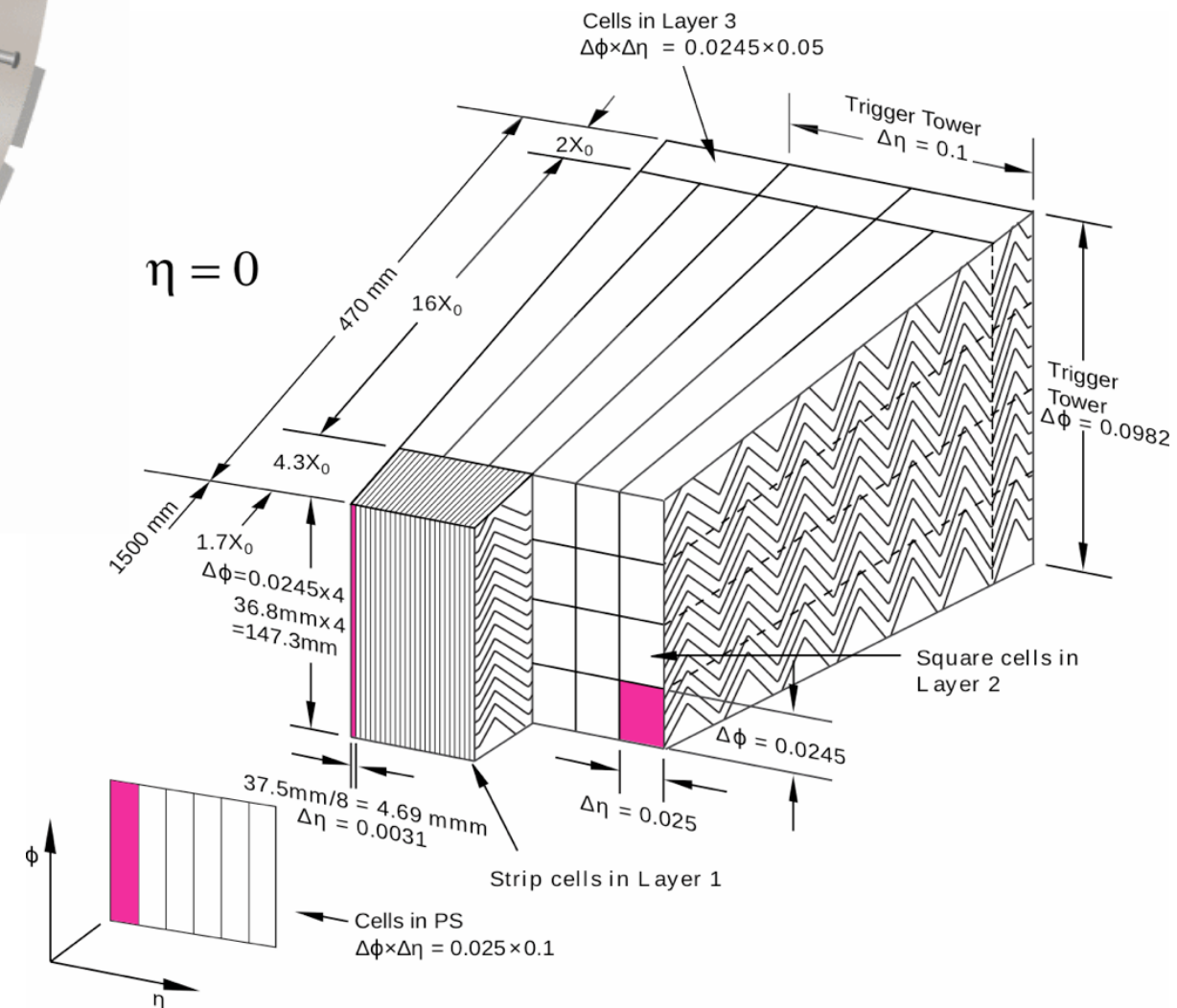

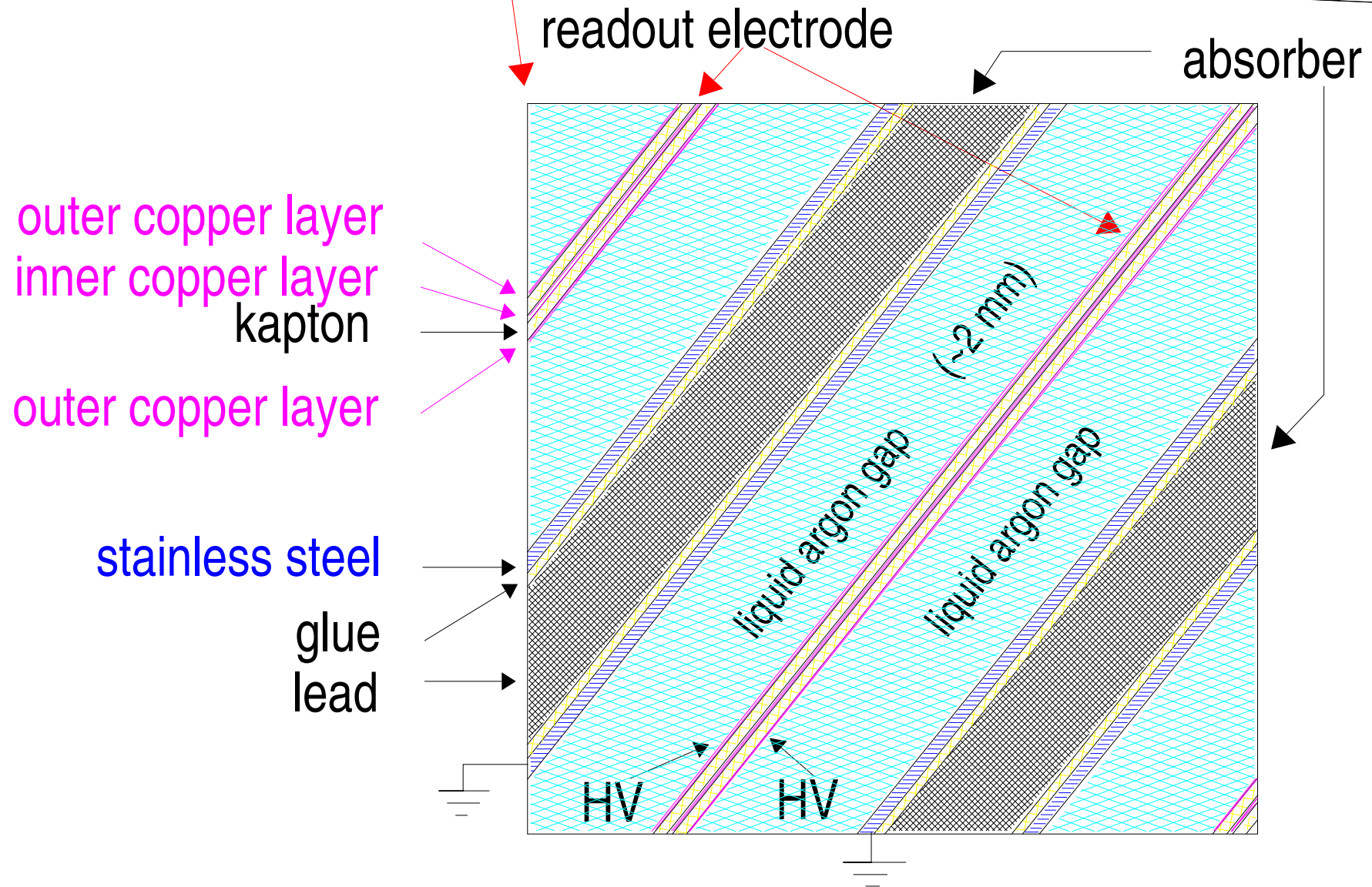
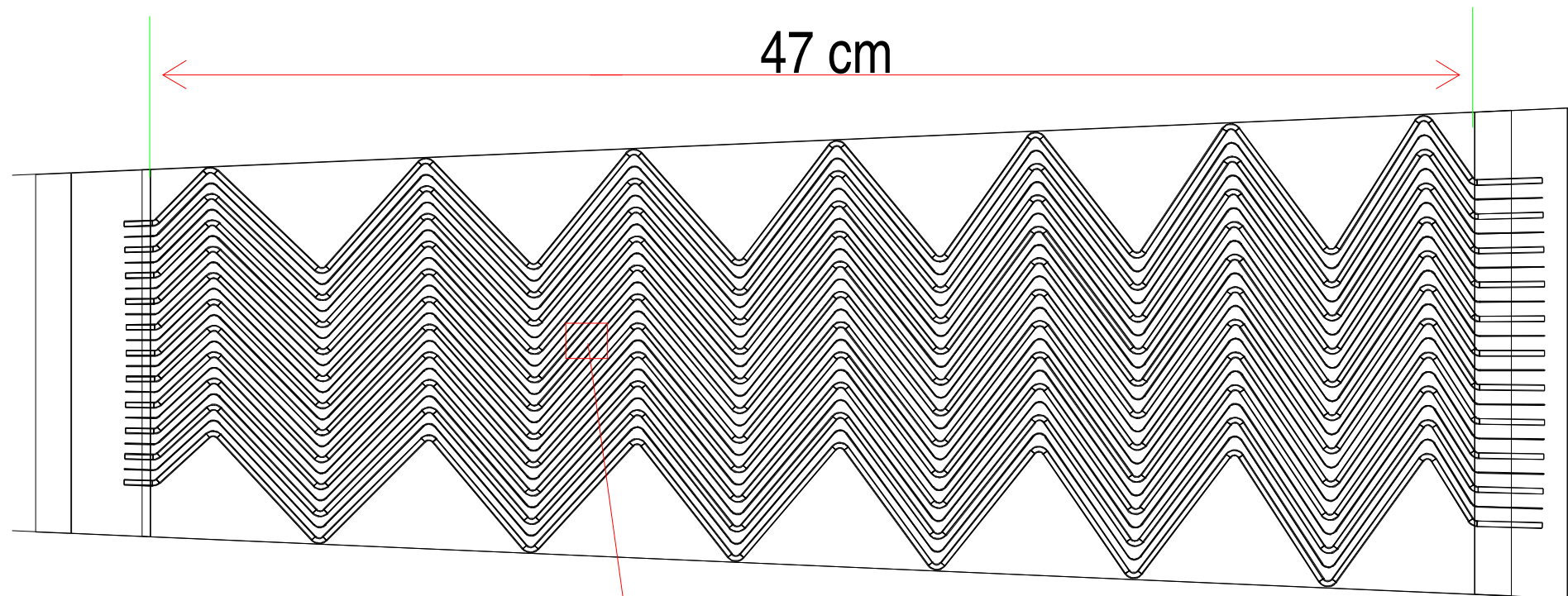

Absorbers and electrodes ~ parallel to direction of particles => "easy" to readout signal from electrodes, no crack.

Zig-Zag angle ("Accordion") to avoid particles travelling only in LAr or only in Pb

Varying angle to keep gap constant as function of radius in projective cylindrical geometry

No cold "active" electronics

Gap size ~2mm

Sampling fraction~15-20%

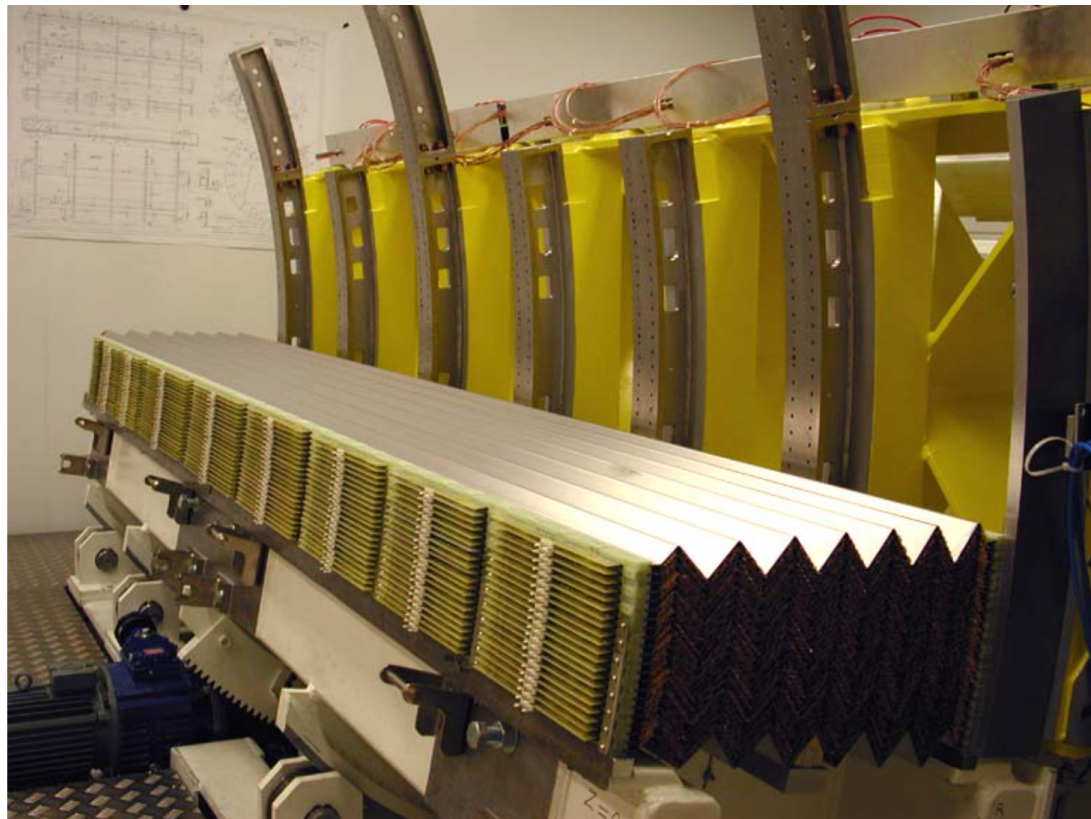
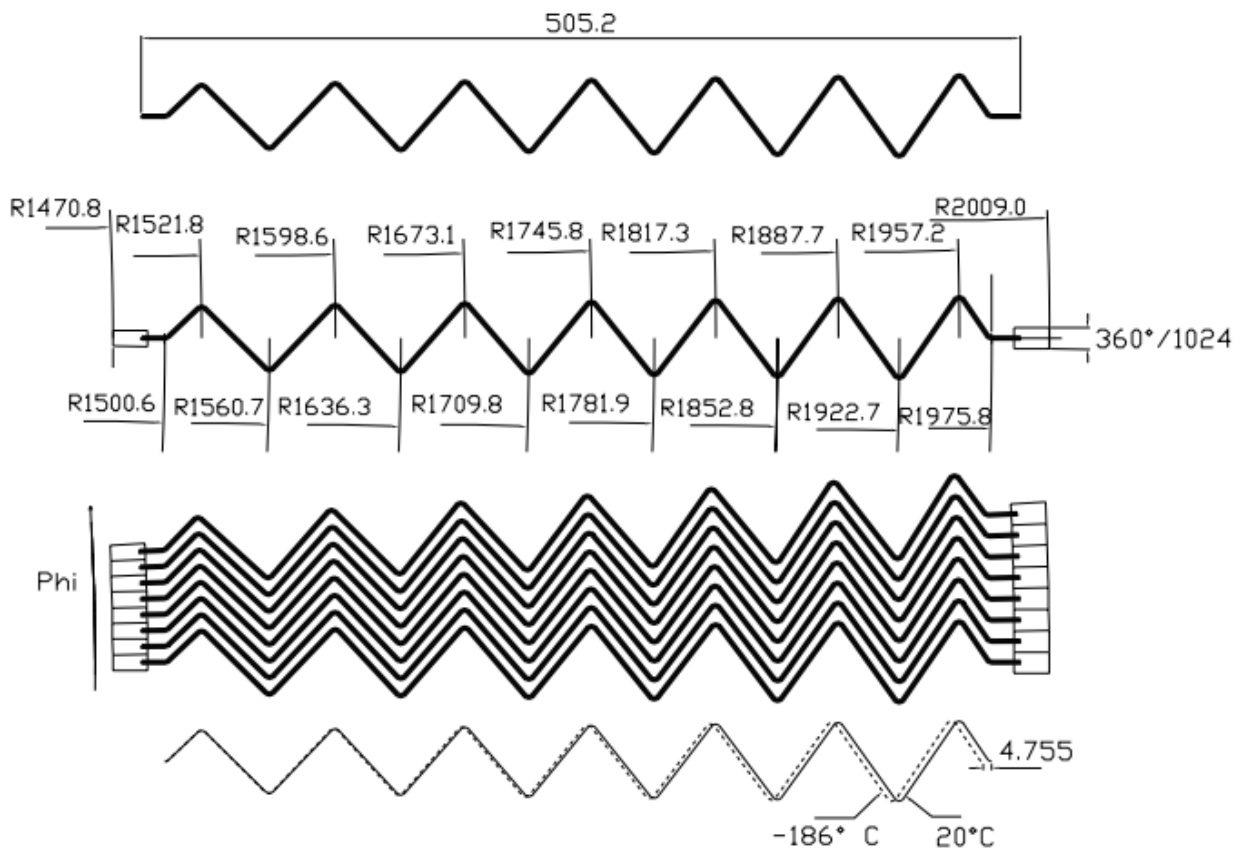

Why do we care about constant gap size ?

If gap size varies along shower axis, response depends on fluctuations of longitudinal shower development

(Ar/Total ratio and initial ionization current/charge variations)

With O(3) long. layers, this gave $\sim 0.65\%$ local constant term on energy resolution (opening gap prototype in 1991)

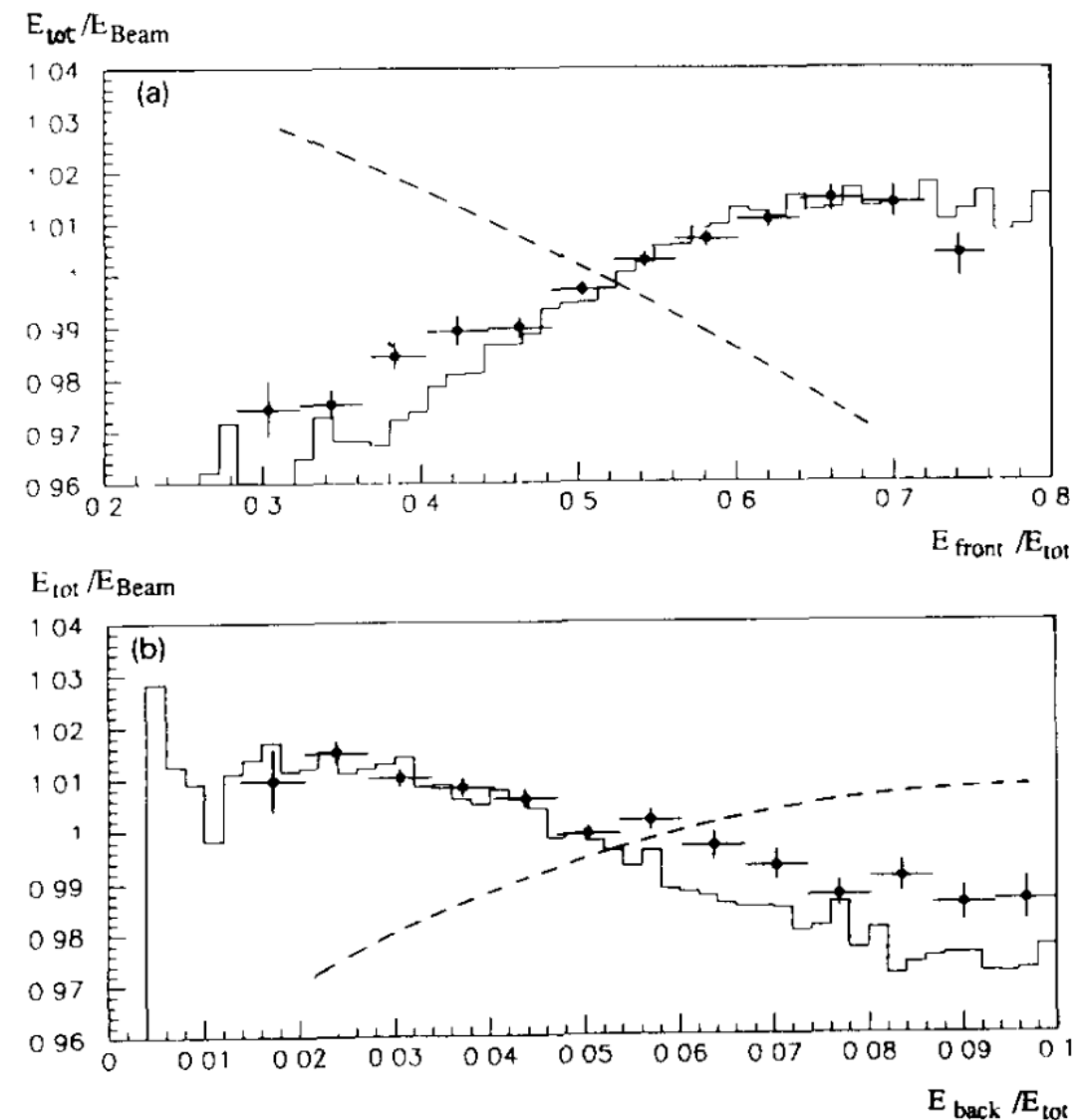

Granularity in eta (z) direction
and in depth defined by drawing
of readout cells on electrodes

3 layers per electrode:
HV-readout-HV

Granularity along phi defined by
grouping of electrodes
1024 electrodes, 4 electrodes
per cell => $2\pi/256$ cells for 2nd
layer

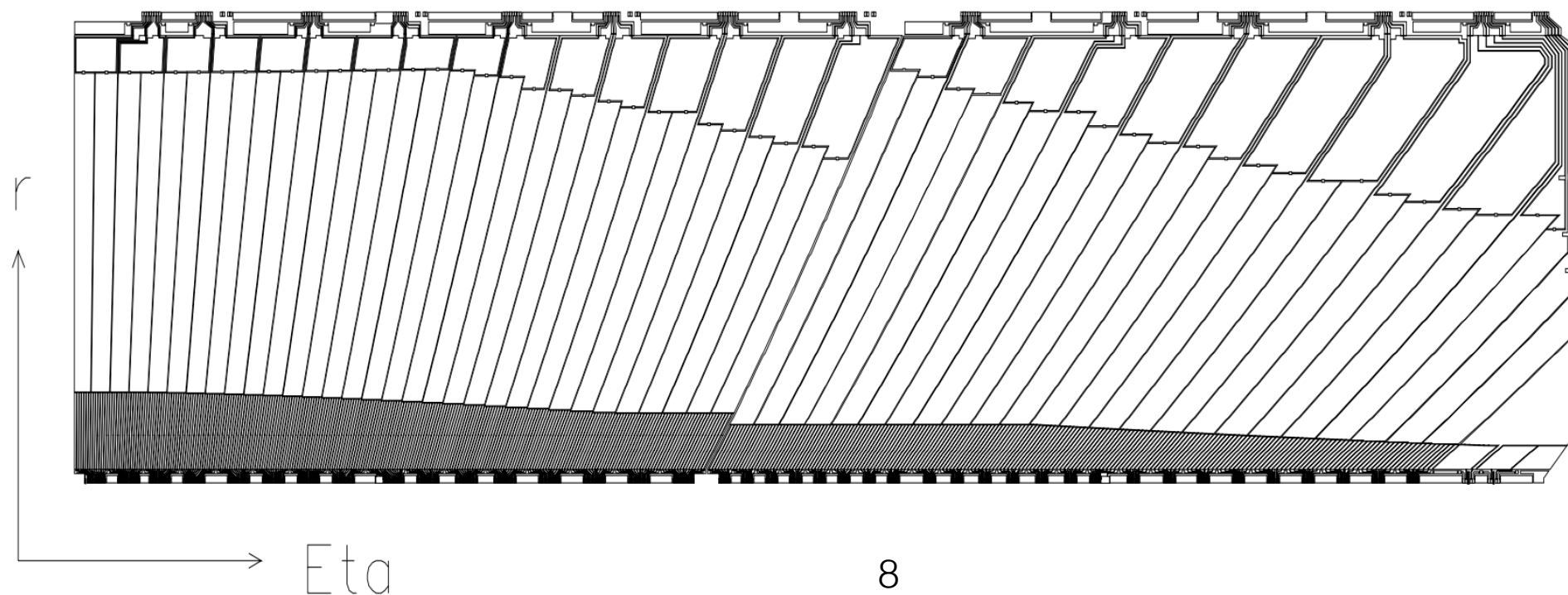
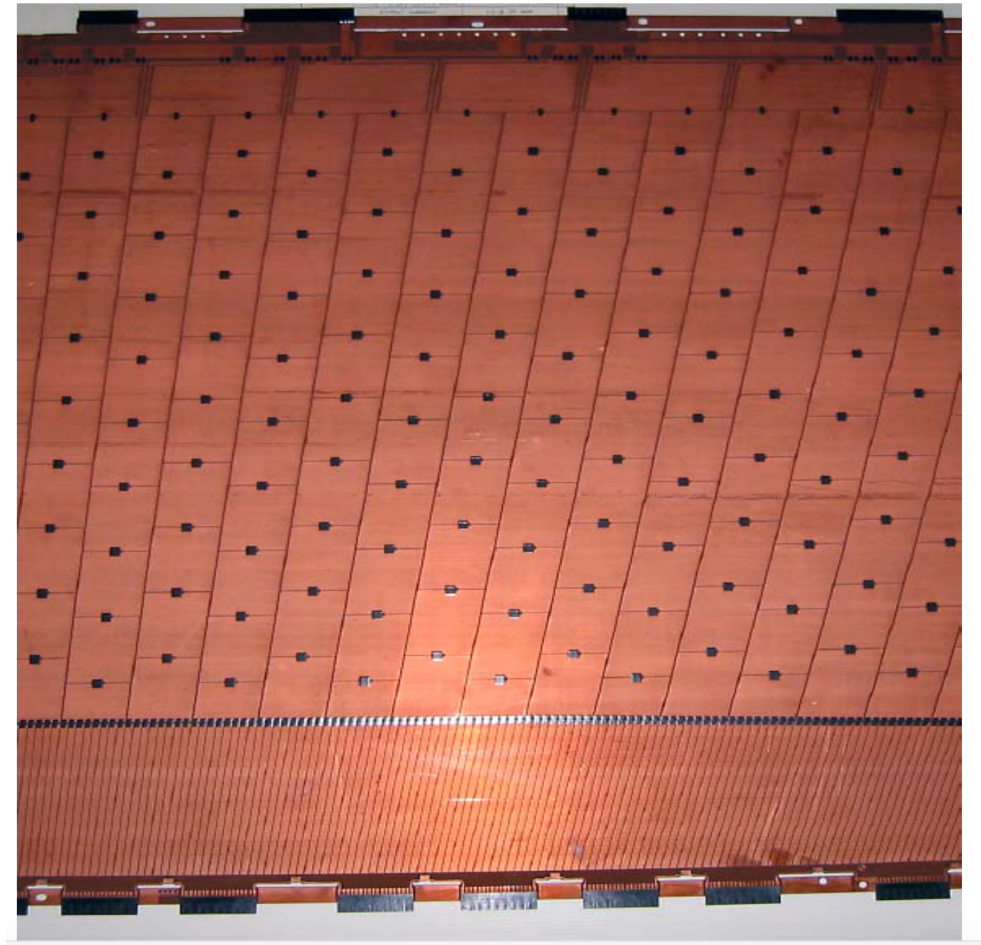

Readout

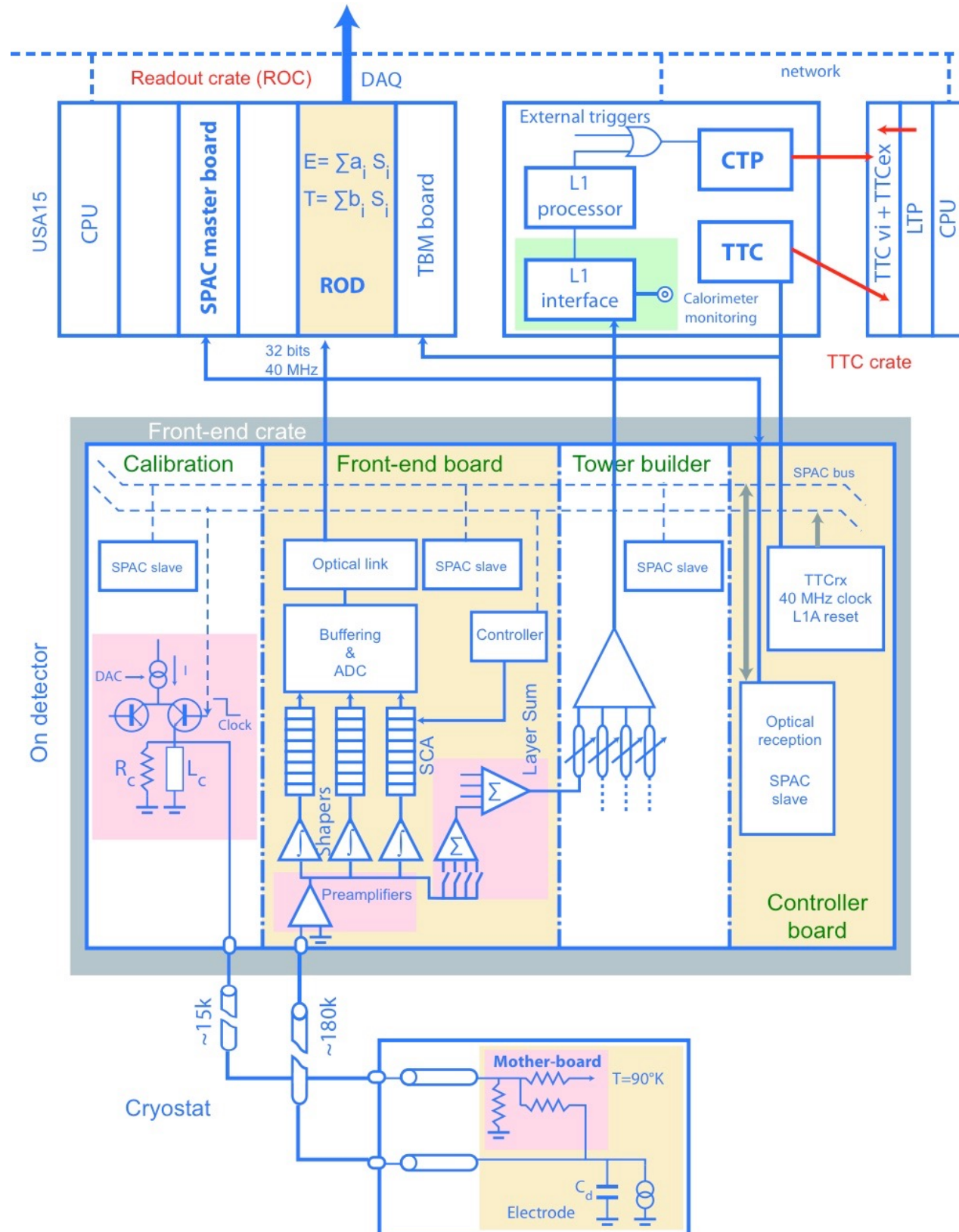

Low noise electronics on the feedthrough to amplify and shape the signal (*3 gains)
 (Signal is $\sim 15 \mu\text{A} / \text{GeV}$)

Analog pipeline to wait for L1 trigger decision

12-bits ADC

Data sent by optical link to back-end electronics for energy reconstruction and input to HLT and readout paths

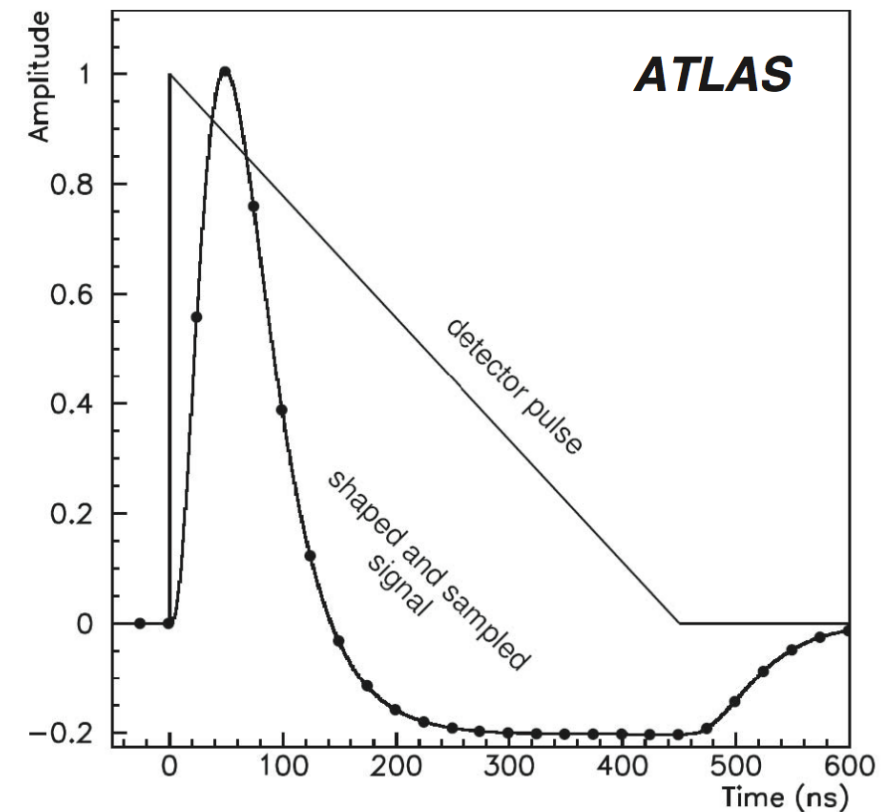

Material before calorimeter

Material upstream EM calo is significant

Conversion reconstruction in the inner detector is also an important ingredient for analysis using photon

- to achieve good photon reconstruction efficiency
- to apply dedicated energy corrections
- to apply dedicated identification criteria

Becomes more challenging at high pileup

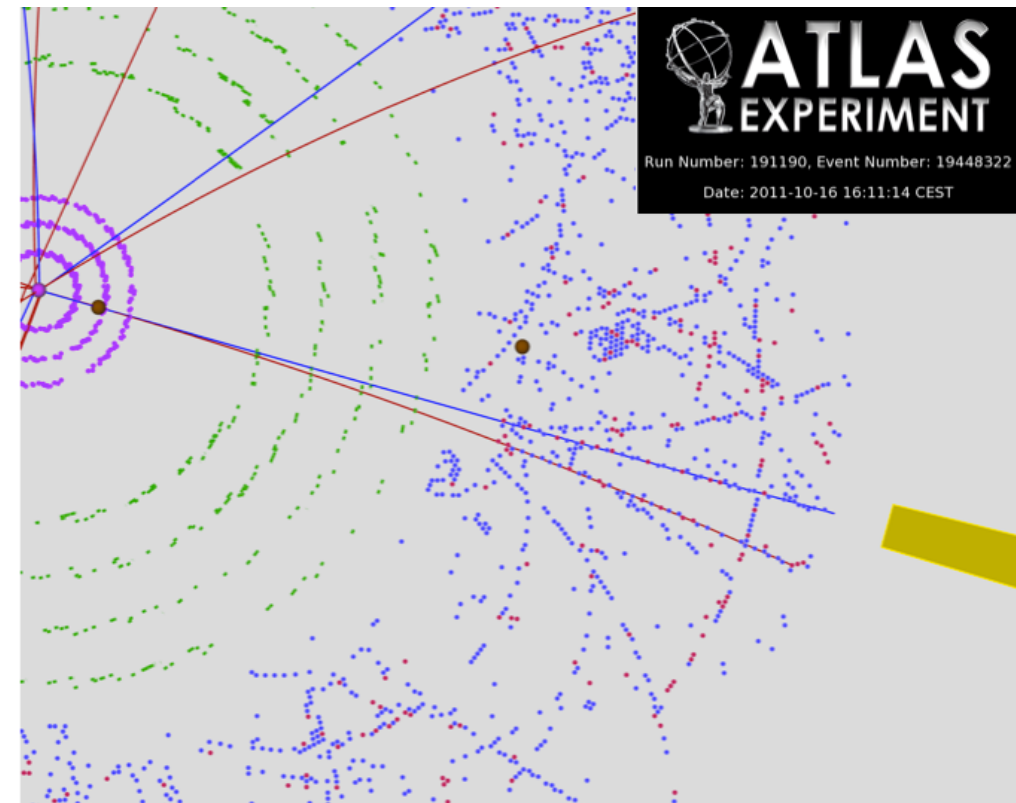
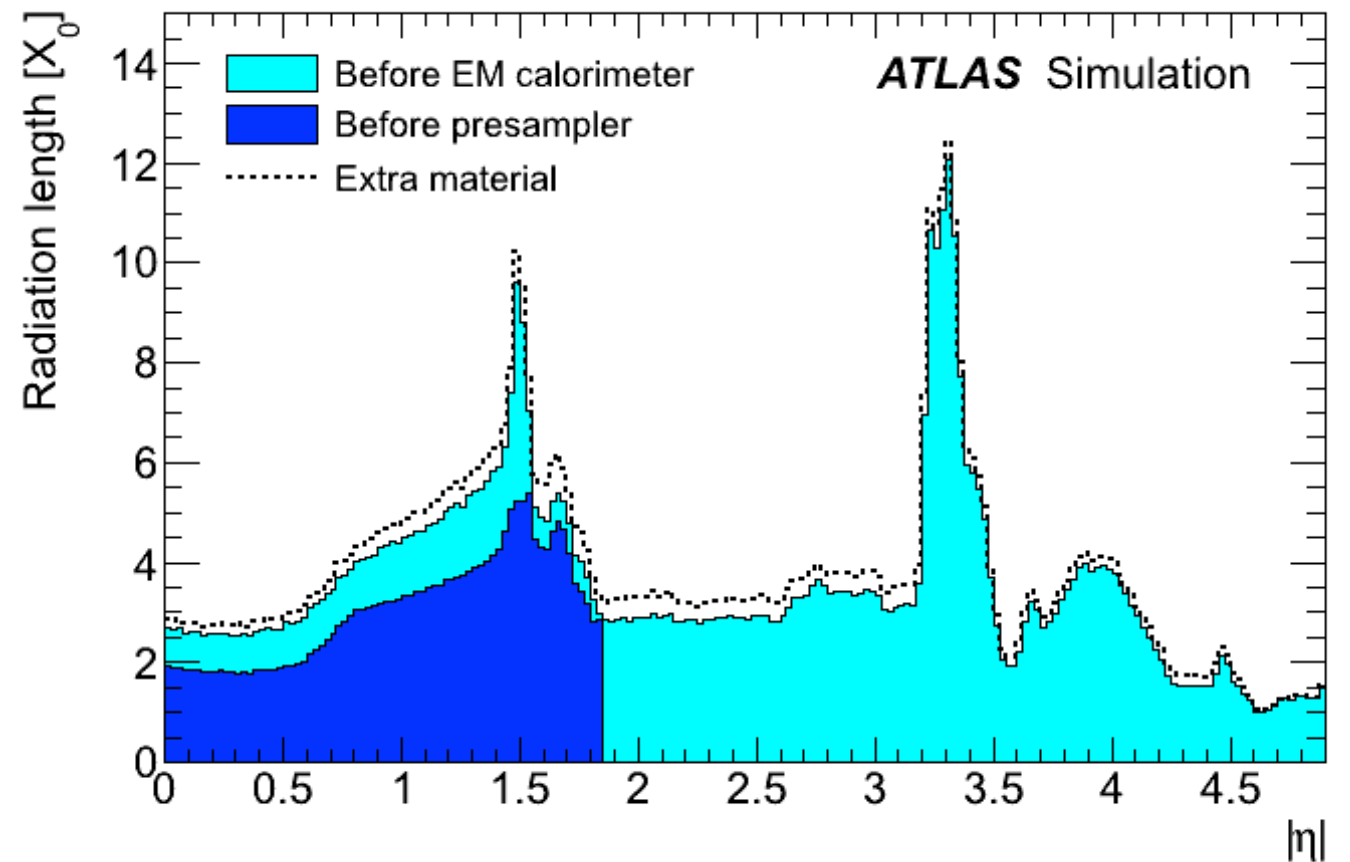

timeline

- 1990: start R&D of accordion LAr calorimeter, first test beam of (small) prototypes
- 1993: LAr accordion calorimeter decided as baseline for ATLAS EM calorimeter
- 1996: Technical design report
- 2000-2003: module assembly, test-beam for some of the production modules (-> uniformity and linearity studies)
- 2004: barrel assembly completed
- 2004: combined test-beam of a "slice" of ATLAS
- End of 2004: barrel calorimeter lowered in ATLAS pit
- 2006: full with LAr, commissioning (cosmics)
- 2008: first beam-splash events
- 2009: first collision events
- 2010-2012: run 1 7,8 TeV 25 fb⁻¹ collected. Higgs boson discovery in 2012
- 2013-2014: LS1
- 2015-2018: run 2 13 TeV, *luminosity ~twice design*, 140 fb⁻¹ collected. **30 interactions per bunch crossing in average.** More precise Higgs boson coupling measurements, observation of ttH production
- 2019-2020: LS2, installation of phase 1 upgrade
- 2021-2023: run 3
- 2024-2026: LS3, installation of phase 2 upgrade
- 2026- : High Luminosity HLC

Basics recipe for $H \rightarrow \gamma\gamma$

- Select candidates with two photons
- ◆ «easy» to trigger
- Reject the jet-jet and gamma-jet backgrounds
- ◆ Needs rejection $O(\text{few } 1000\text{'s})$ against jet background.
- ◆ Reject high energy π^0 from jets which look almost like photon in the calorimeter*
- Reconstruct invariant mass as precisely as possible $M^2 = 2E_1.E_2(1-\cos(\theta))$
- ◆ Calorimeter energy resolution*
- ◆ Angular resolution (i.e need to know production vertex of photon pair)*
- Optimize analysis to improve S/B separation and statistical power
- ◆ Additional kinematical variables
- ◆ Categories
- Background directly measured from data

* depends strongly on EM calorimeter performance

Outline

- Photon (and Electron) identification exploiting the calorimeter granularity
- Position and direction measurement with the calorimeter
- Photon and electron energy calibration and data-driven studies
- Application to $H \rightarrow \gamma\gamma$ analysis from 2012 to now
- Phase 1 and Phase 2 upgrades

Photon (and Electron) Identification

Main goal: distinguish direct photons from jets including case where jets fragment to «single» π^0

Rely on high transverse granularity:
Layer 1 $d\eta$ size 0.0031 in Barrel ($\sim 5\text{mm}$)
 $\sim 5 X_0$ thick

For a 40 GeV π^0 , minimal separation $\Delta R \sim 0.006$
Apply strict criteria on lateral shower shape in the first two layers of the EM calo

For electrons, backgrounds are $b \rightarrow e$, photon conversions and charged pion track misidentified as electron - similar identification criteria but more use of track-based variables

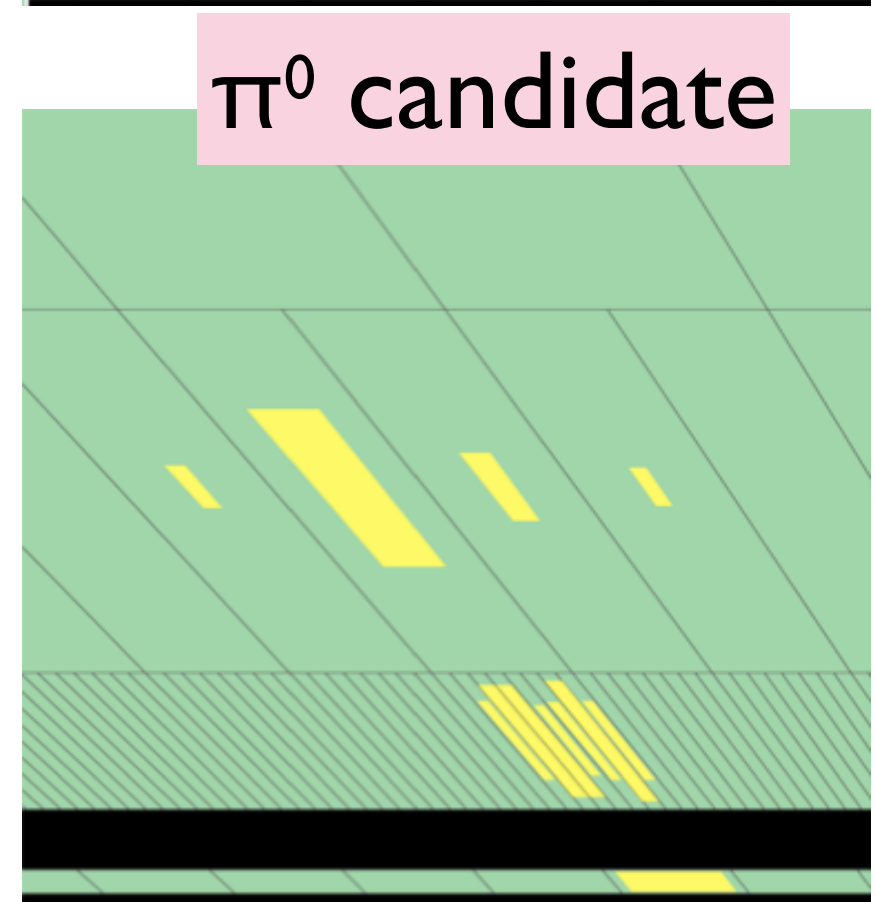
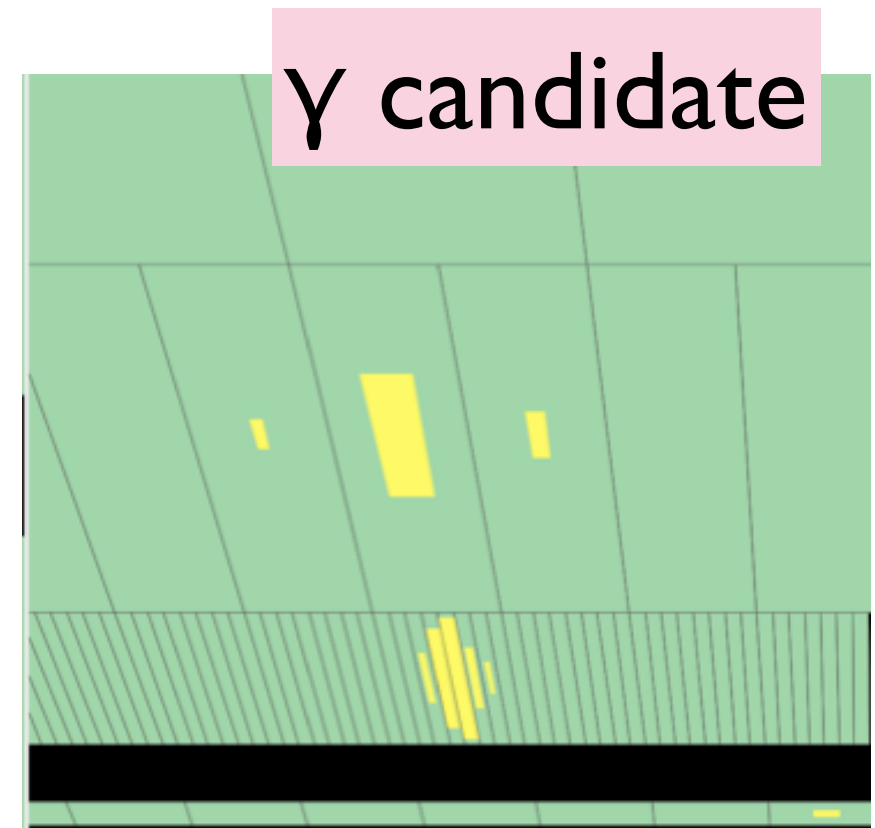

"Shower shape" variables

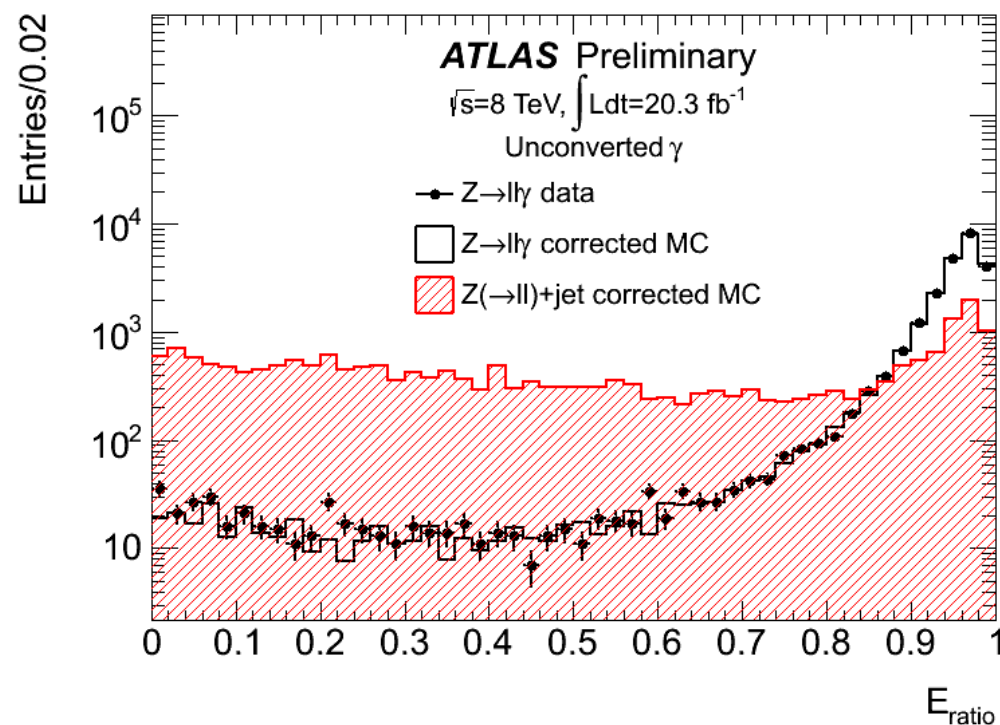
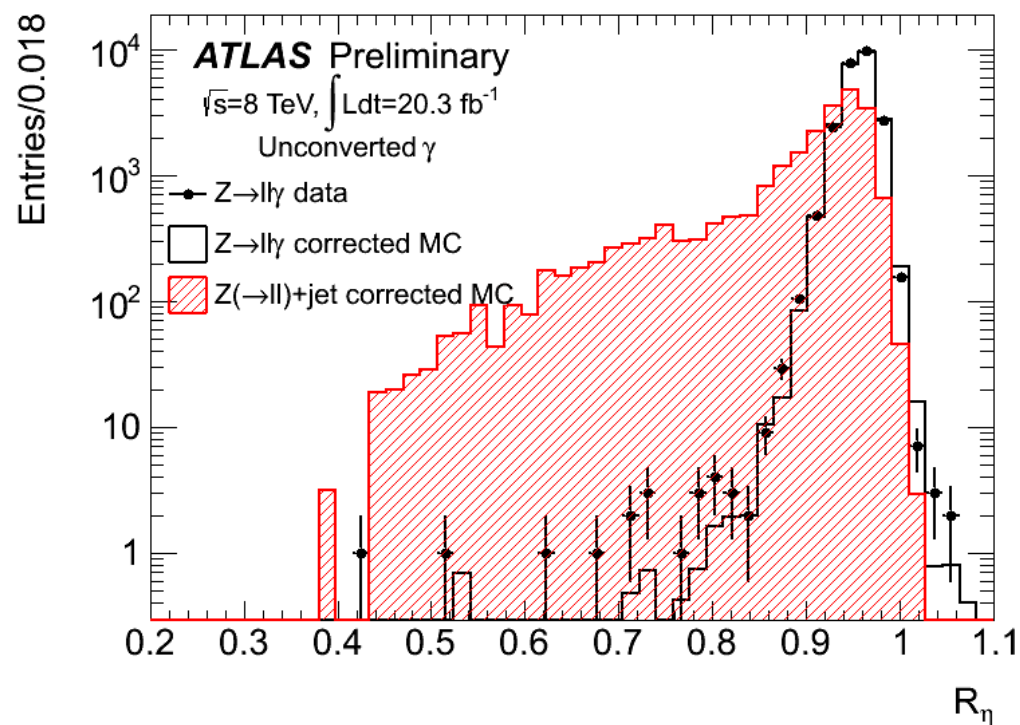
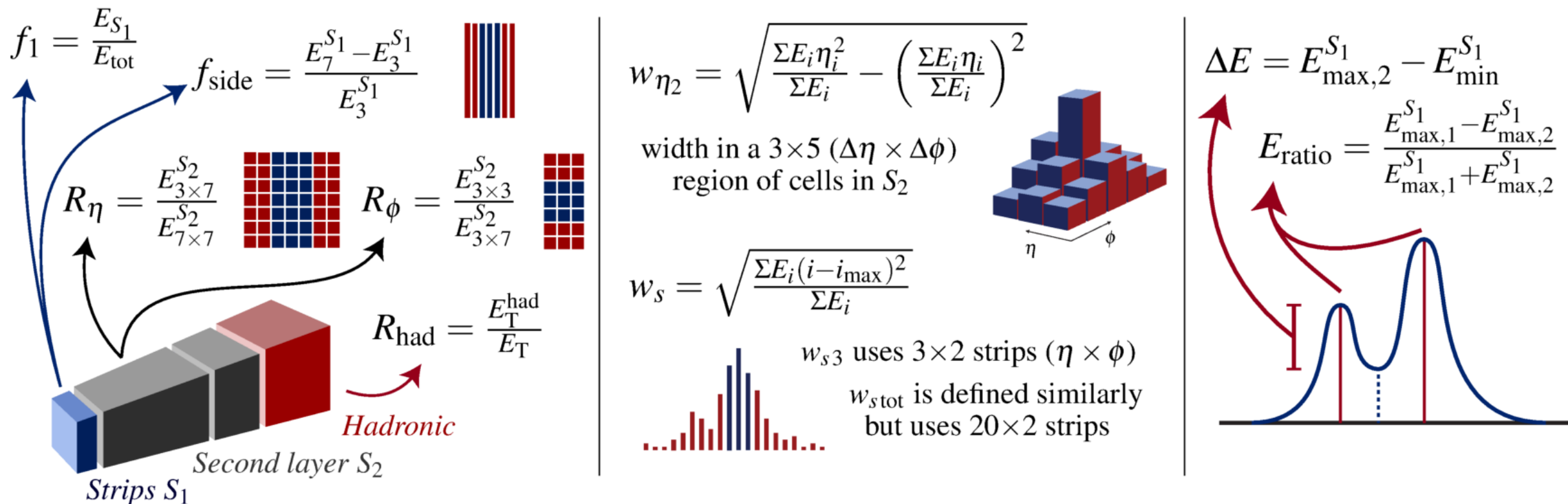

Data/MC comparison of calorimeter shower shape variables using clean $Z \rightarrow ee$ events

Data shower shape slightly wider than in simulation

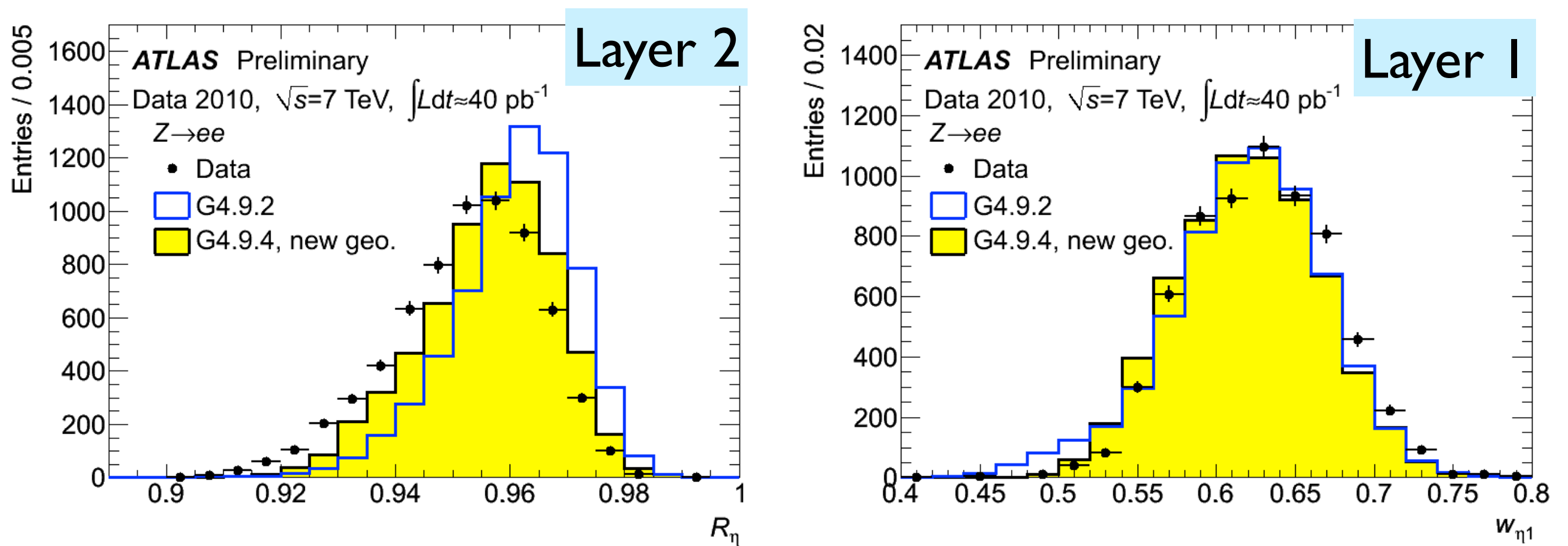

For photon identification efficiency computation:
Take MC, apply shifts to make shower shapes agree with
data

Many ingredients enter in simulation of shower shape variable

- detector geometry
- Geant4 transport and physic processes
- simulation of charge collection and readout

Largest cross-talk is LI-LI in eta (capacitive)
Other cross-talks are $O(0.5-1\%)$, sometime more complicated

Measured in electronics calibration run and applied to MC simulation

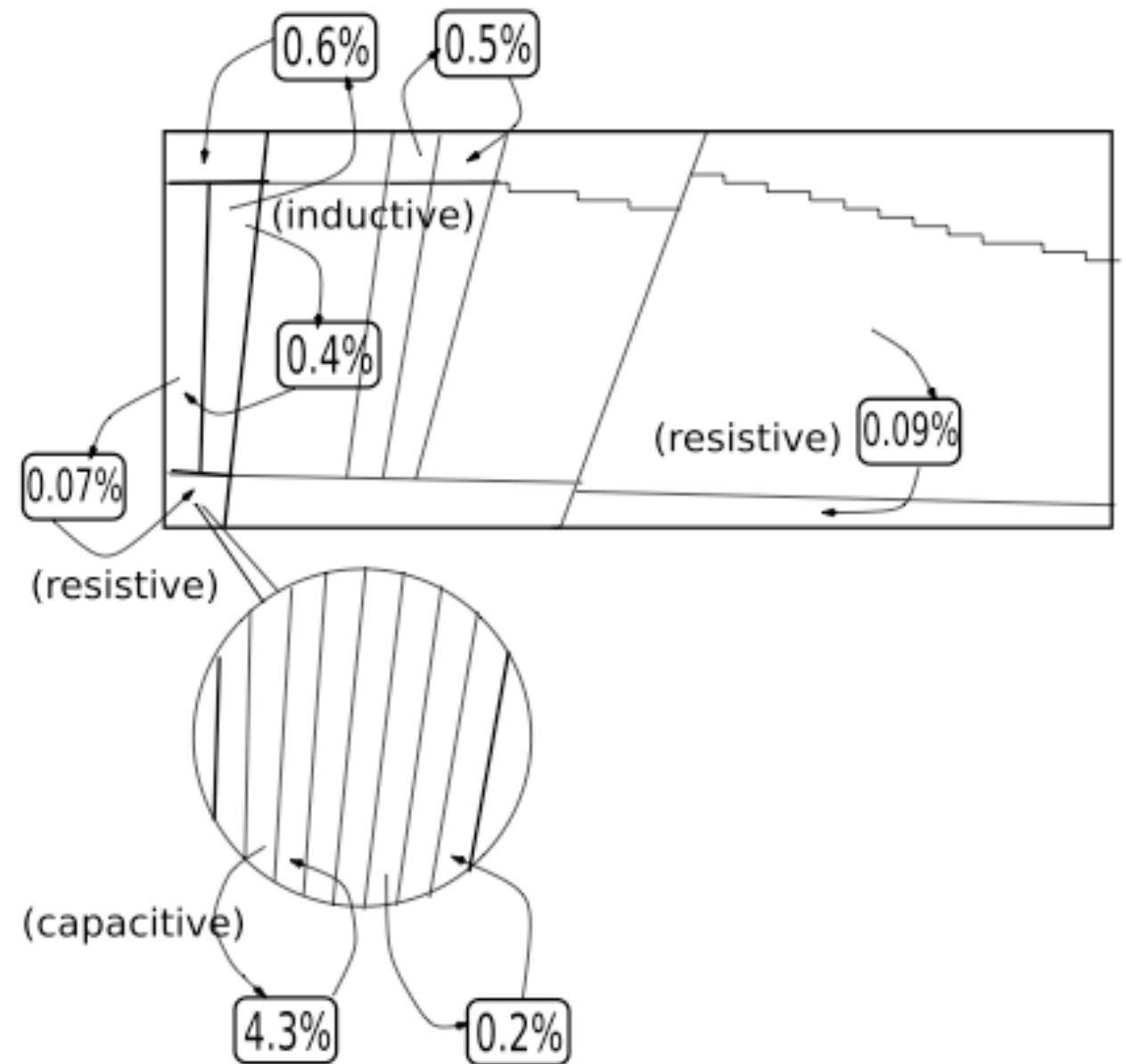

Measurement of photon identification efficiency with data

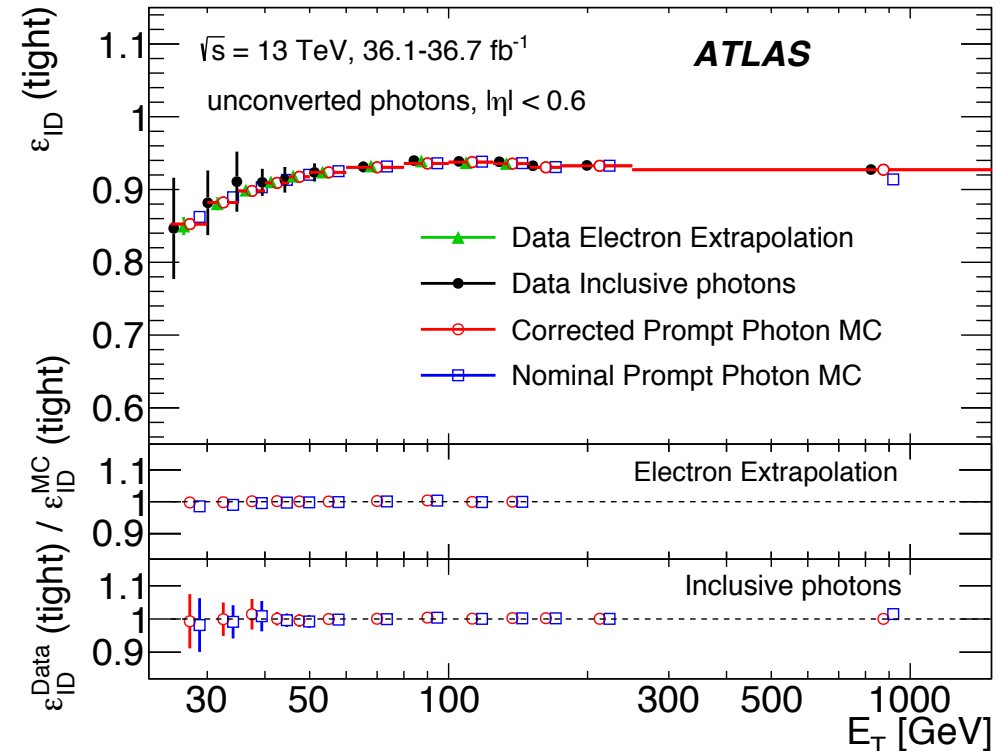
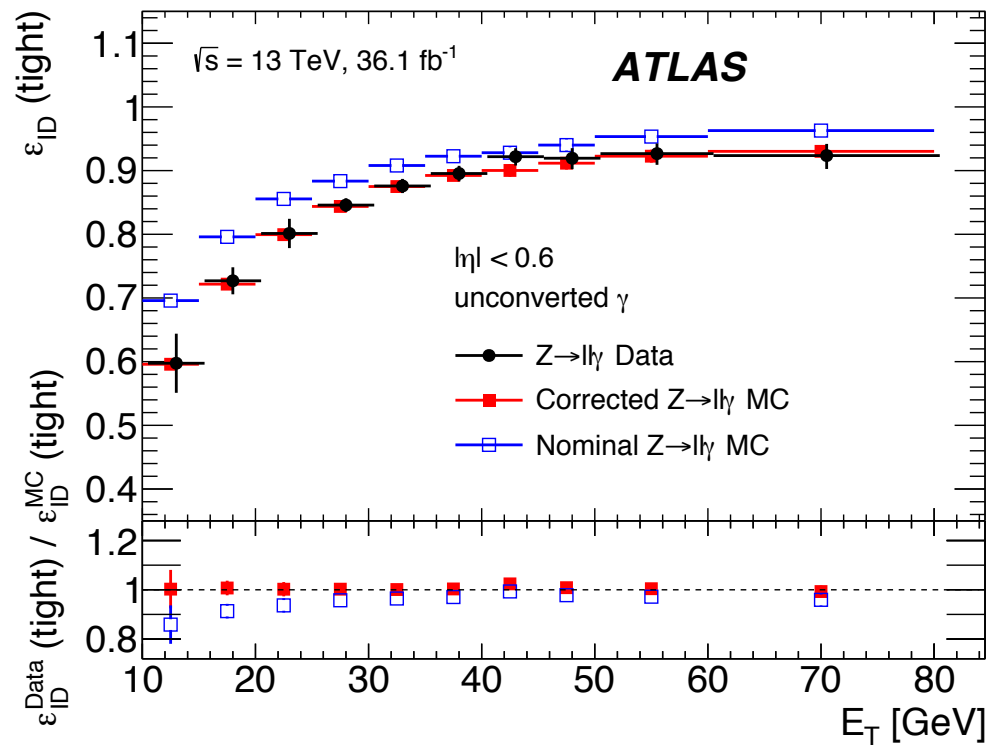

3 techniques:

- $Z \rightarrow ll \gamma$ for low E_T photons
- $Z \rightarrow ee$ with $e \rightarrow$ photon "transformation"
- high E_T inclusive photons with bkg subtraction

=> ~% level precision on photon identification efficiency

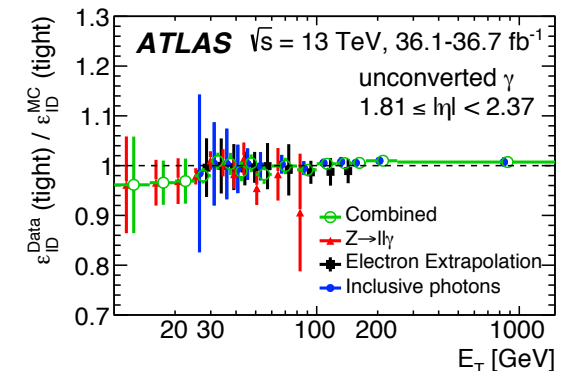
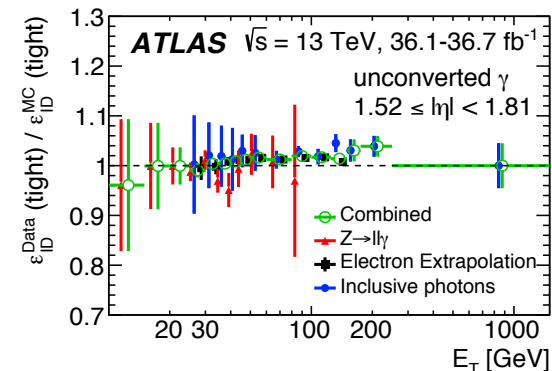
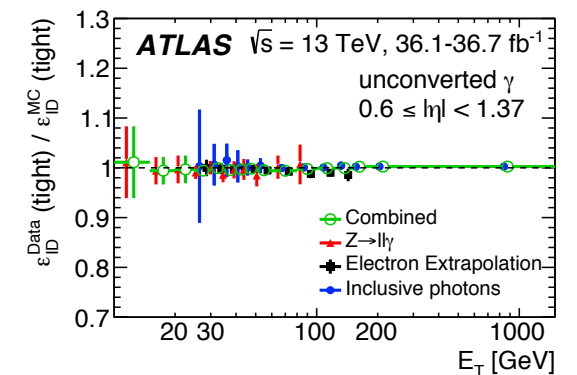
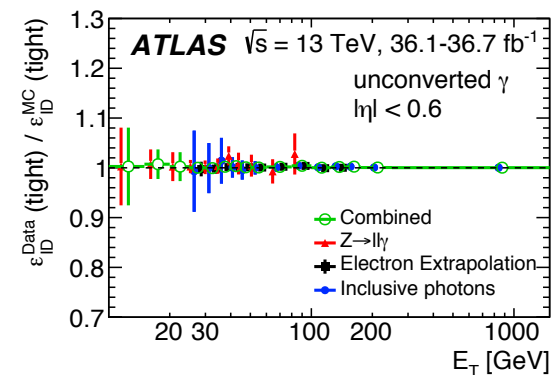

A lot of effort over time to keep the identification efficiency not too affected by pileup

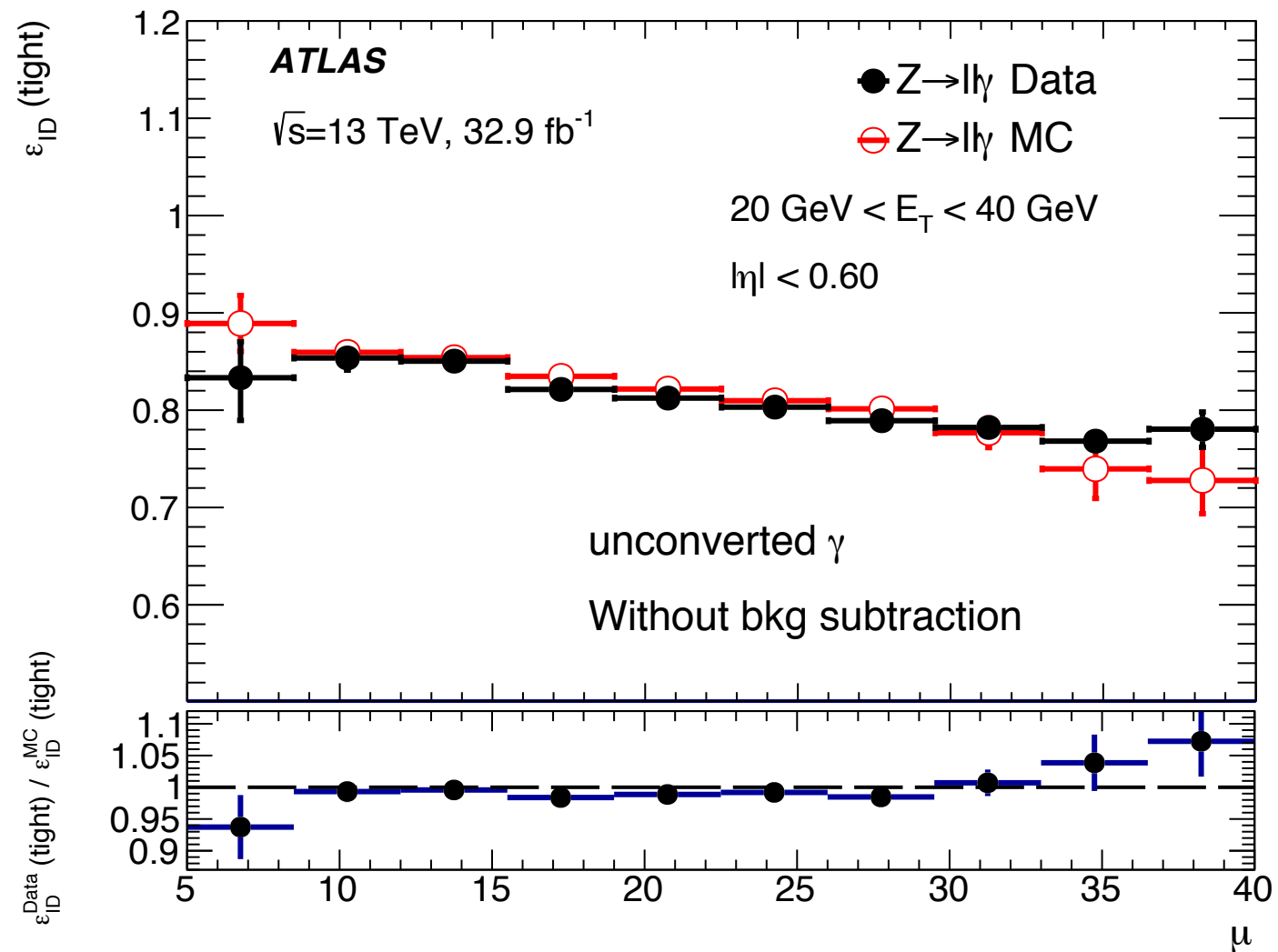

Application of photon identification to $H \rightarrow \gamma\gamma$

2 photons with "tight" identification $E_t > 40$ GeV typically
Isolation requirements using calorimeter and inner detector

Purity measured in data to separate the different components:
gamma-gamma, gamma-jet, jet-jet

2012 discovery sample
purity $\sim 80\%$

2015-2017 dataset
purity $\sim 80\%$

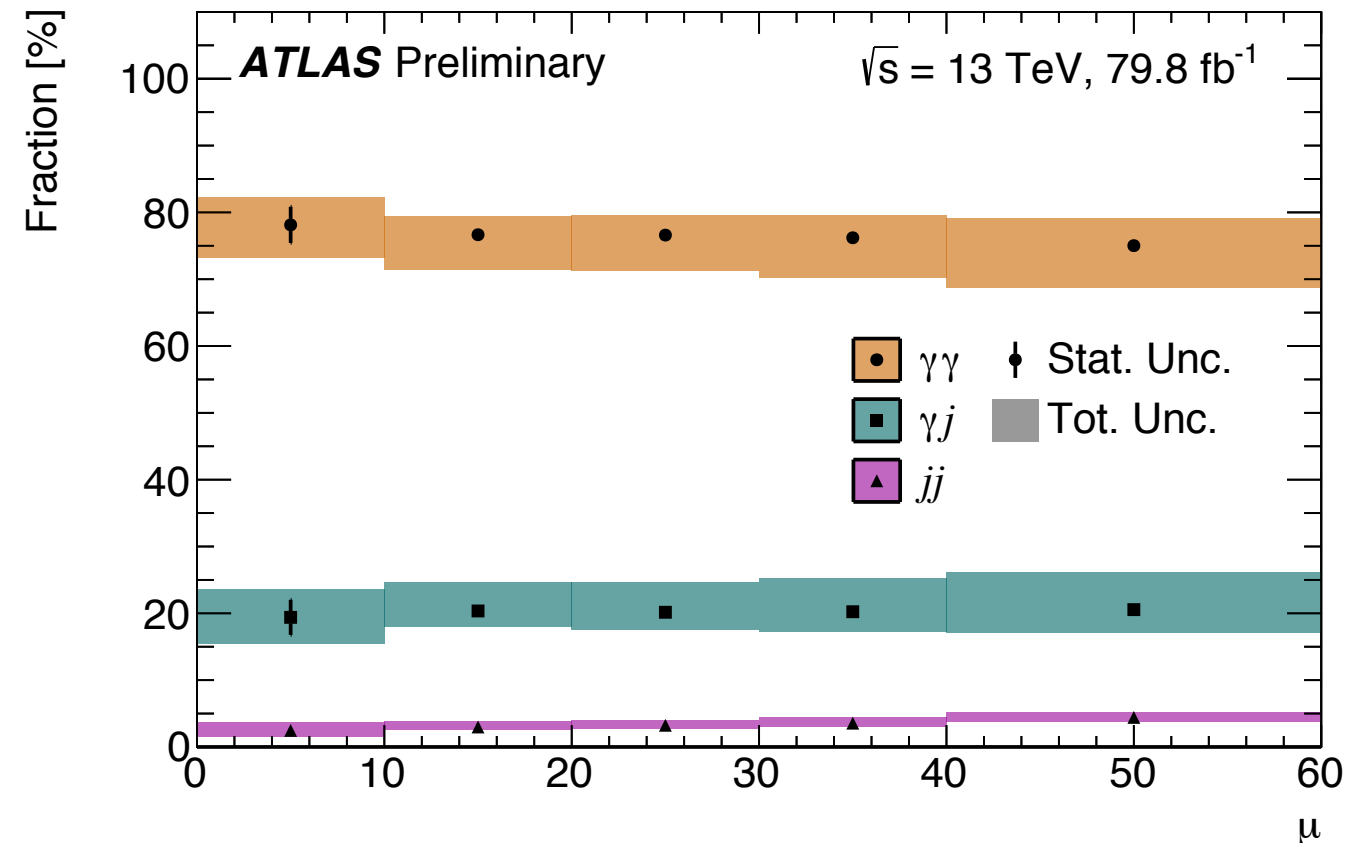
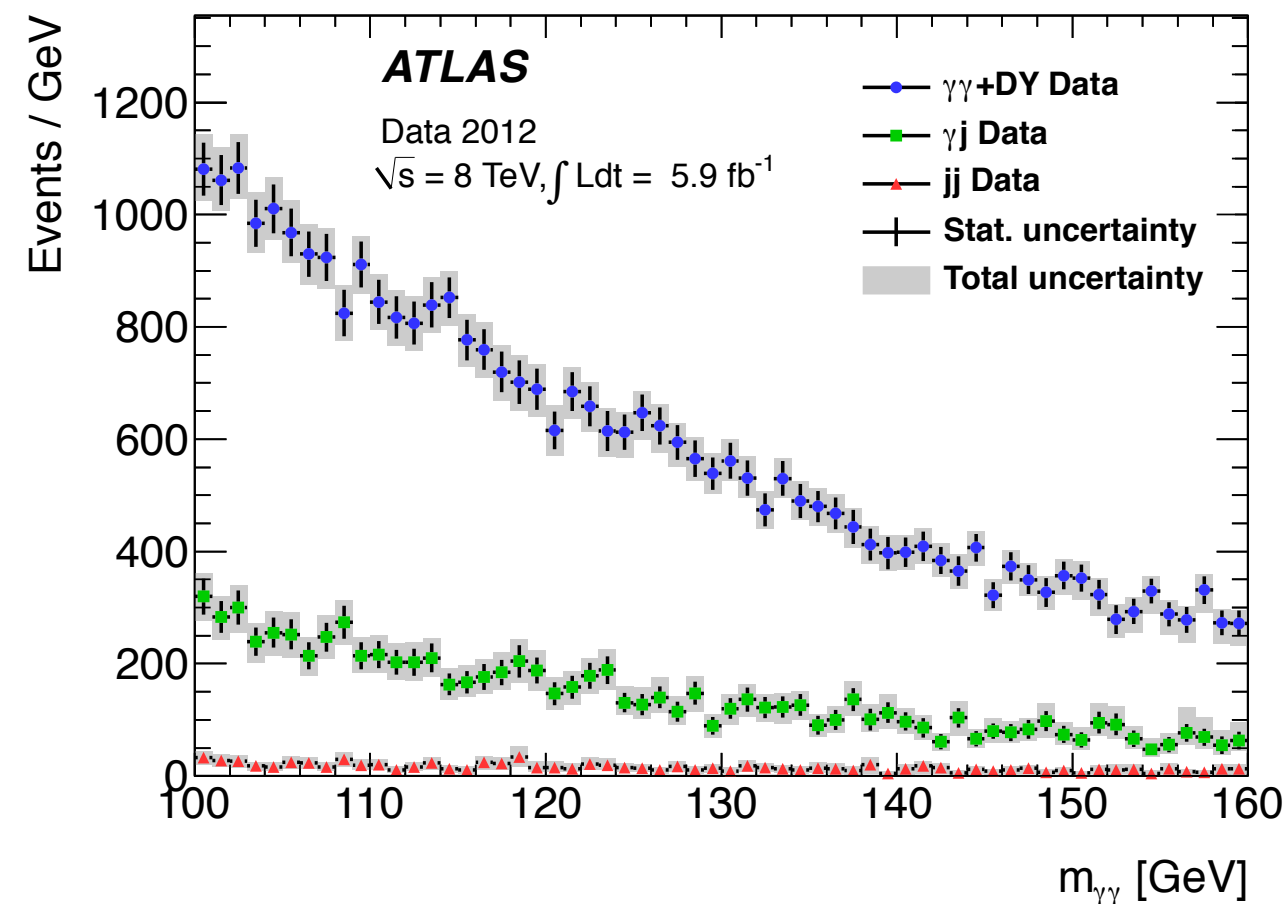

Outline

- Photon (and Electron) identification exploiting the calorimeter granularity
- **Position and direction measurement with the calorimeter**
- Photon and electron energy calibration and data-driven studies
- Application to $H \rightarrow \gamma\gamma$ analysis from 2012 to now
- Phase 1 and Phase 2 upgrades

Position and direction measurements

- Position of impact point of showers in the calorimeter in eta and phi computed by barycenter of cell energy deposits
- Corrected for bias due to finite cell size
- Typical resolutions $\sim 0.5 - 1$ mm

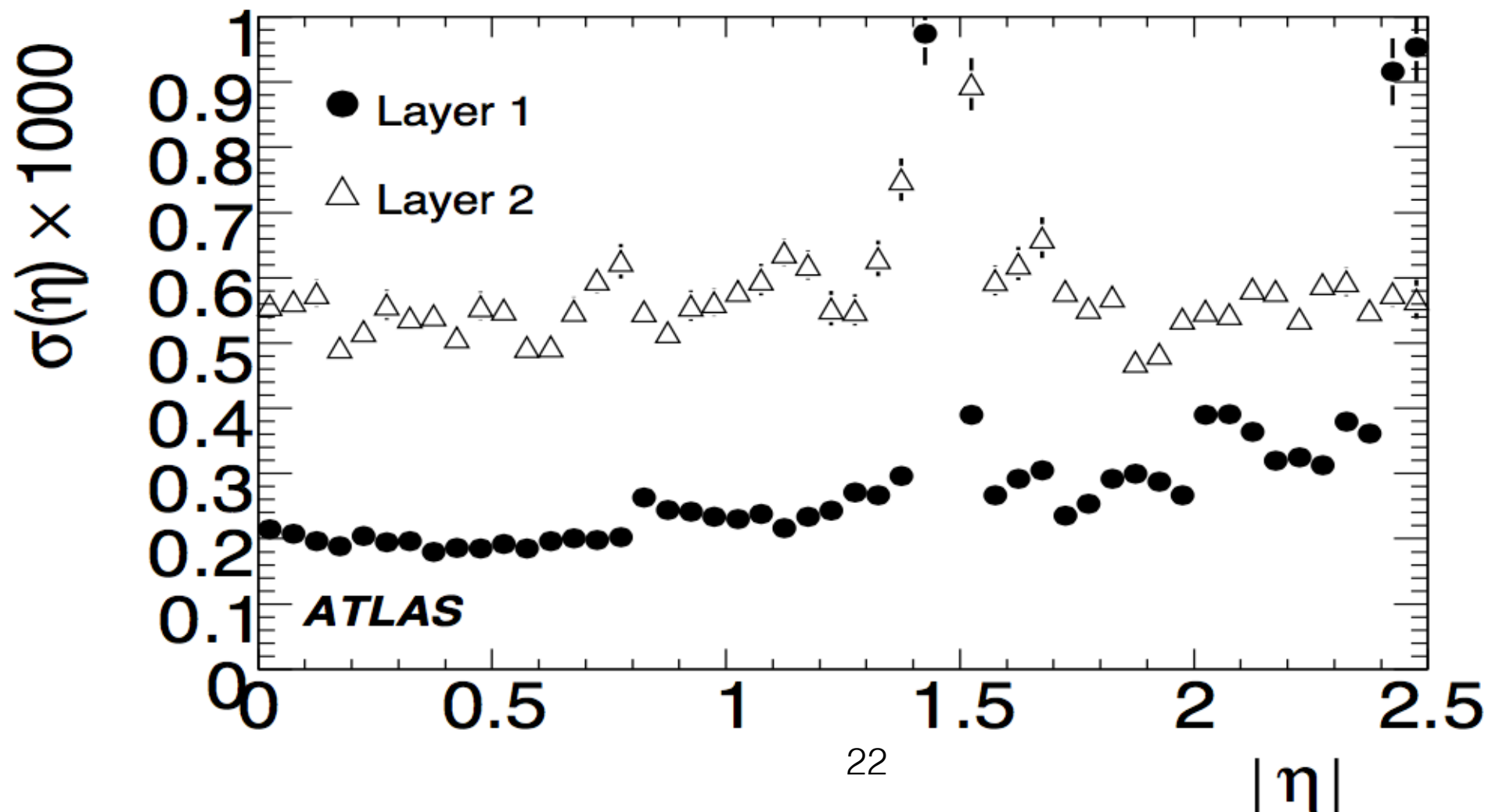

In data, apply correction for calorimeter position wrt to inner detector

Position measurements also sensitive to deformation of calorimeter structure under the influence of gravity ("pear" shape of the inner ring, absorber sagging)

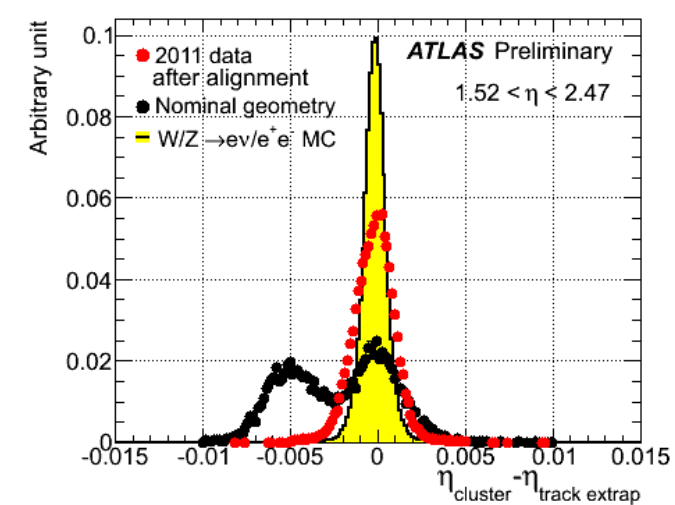
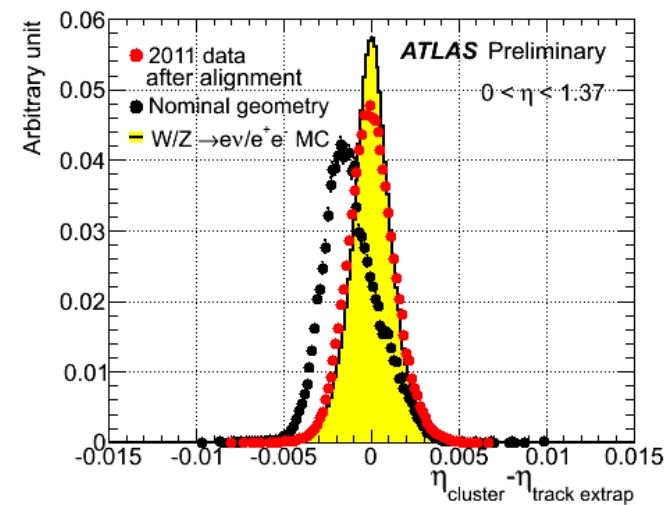
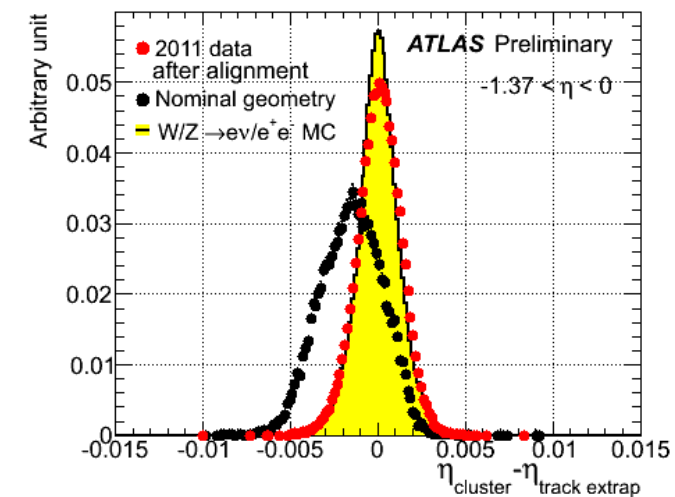
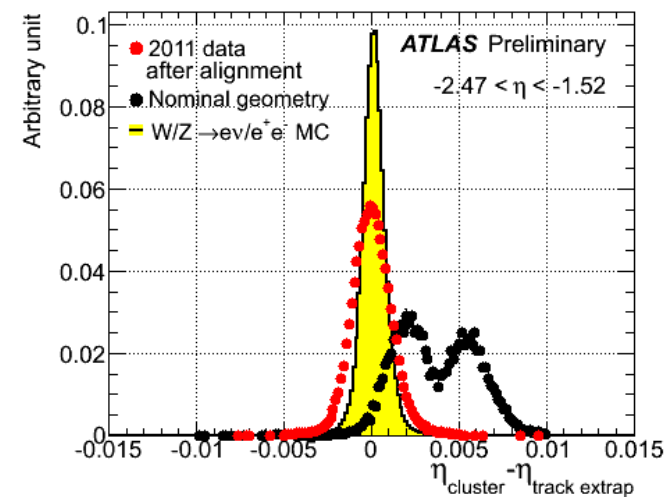
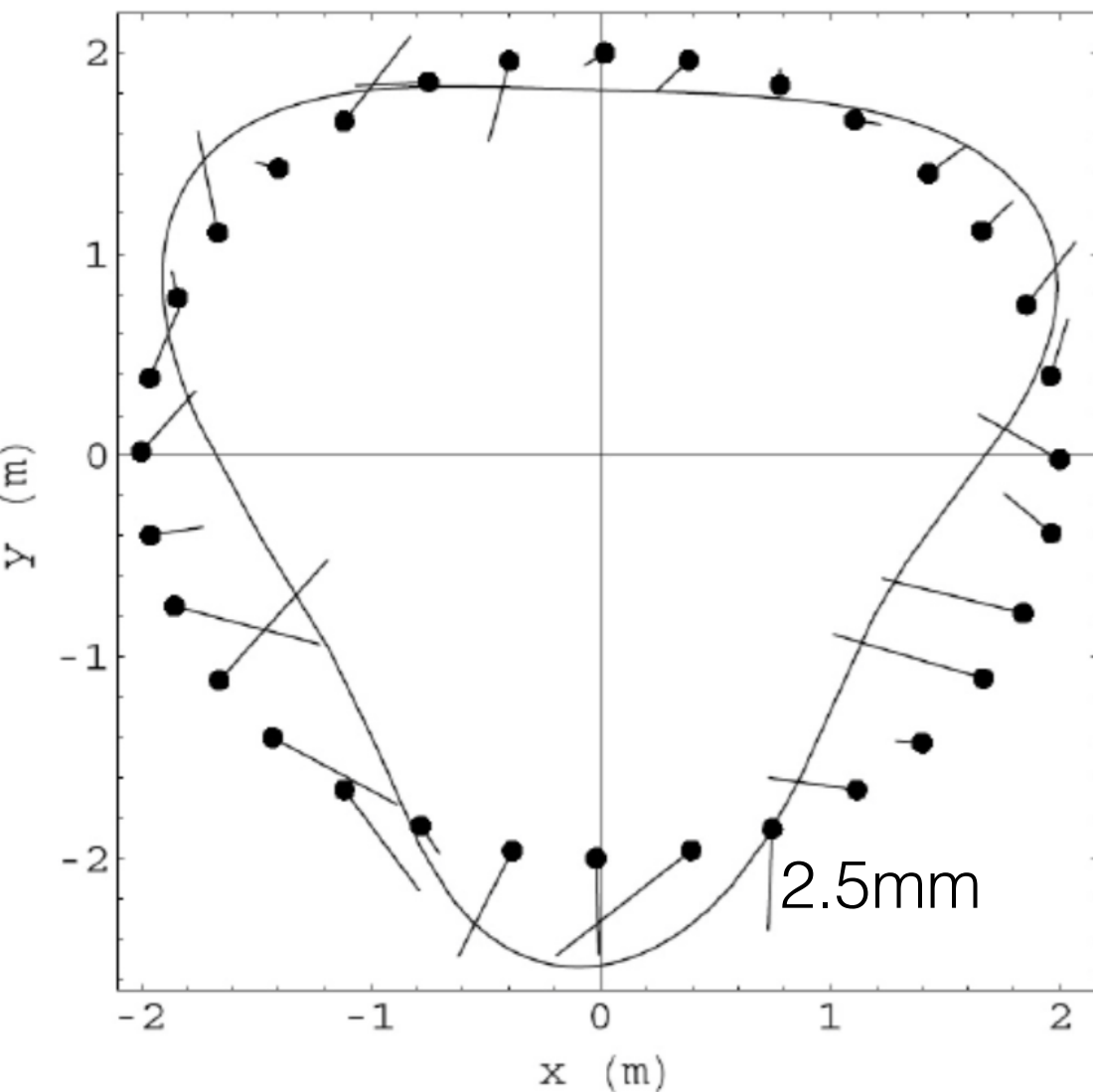

For the mass, we also need the angle between photons

At the LHC, the transverse interaction point is well known (~ 15 micron spread) while the longitudinal vertex position has ~ 4 cm spread

One needs an event-by-event estimate of the z position of the pp collision that produced the photons (but there could be up to ~ 60 pp collisions in the same bunch crossing)

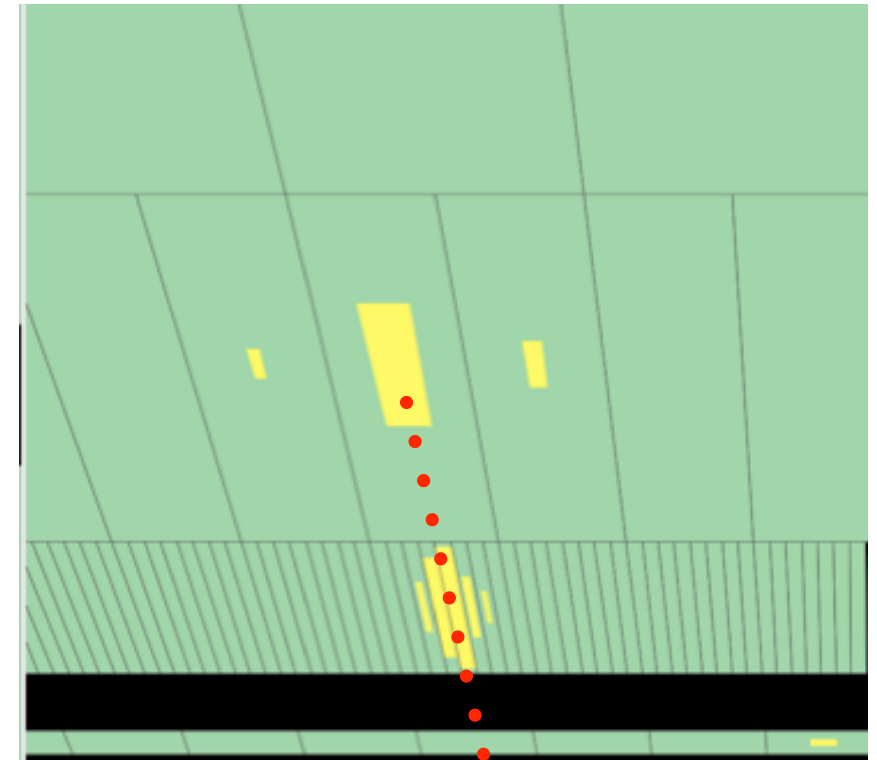

For unconverted photon, estimate z with calorimeter «pointing»

For early converted photons, use track

Combine both photons to get best estimate of $z(\text{vertex})$

(not to scale)

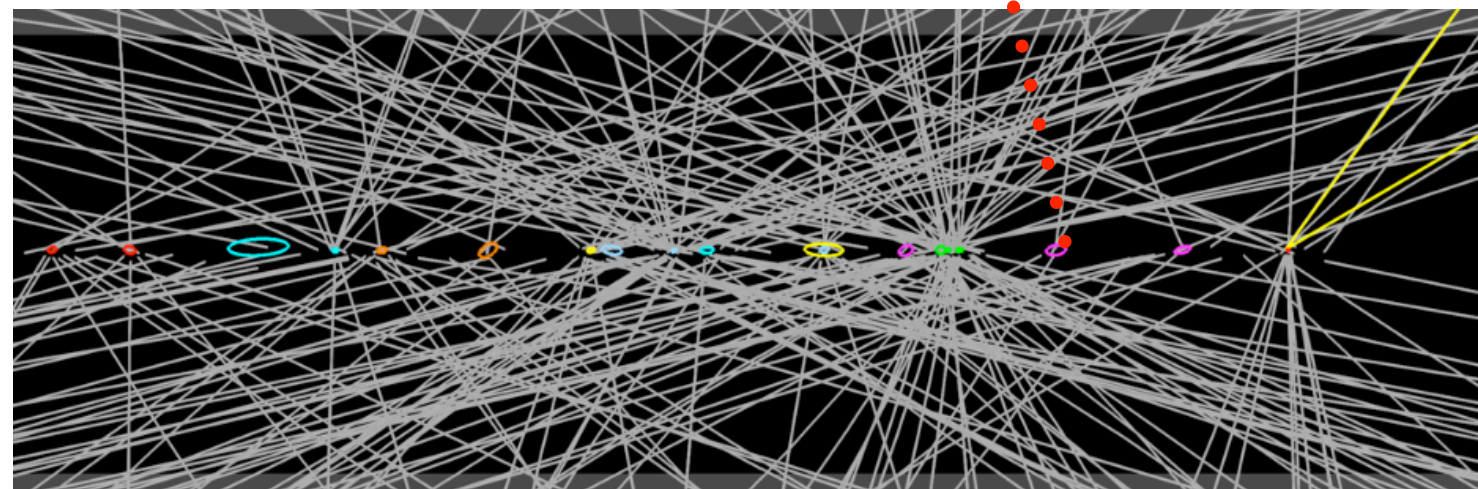

Pointing with data

check with electrons using track as reference

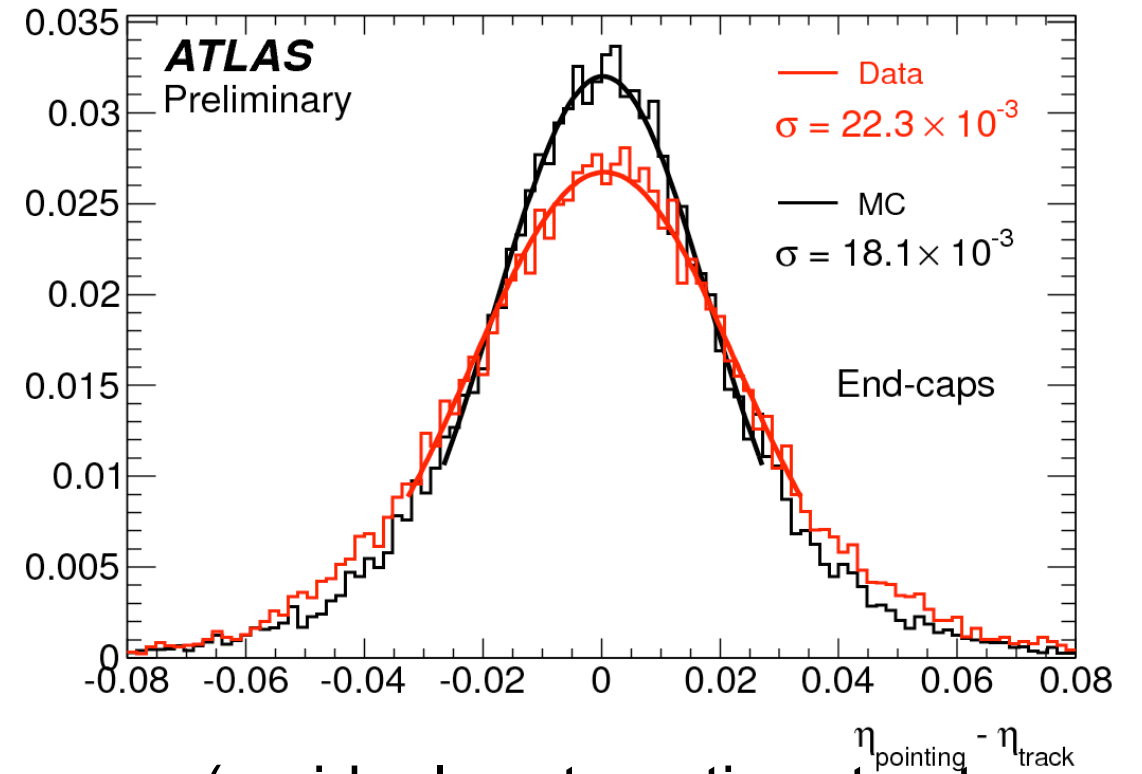
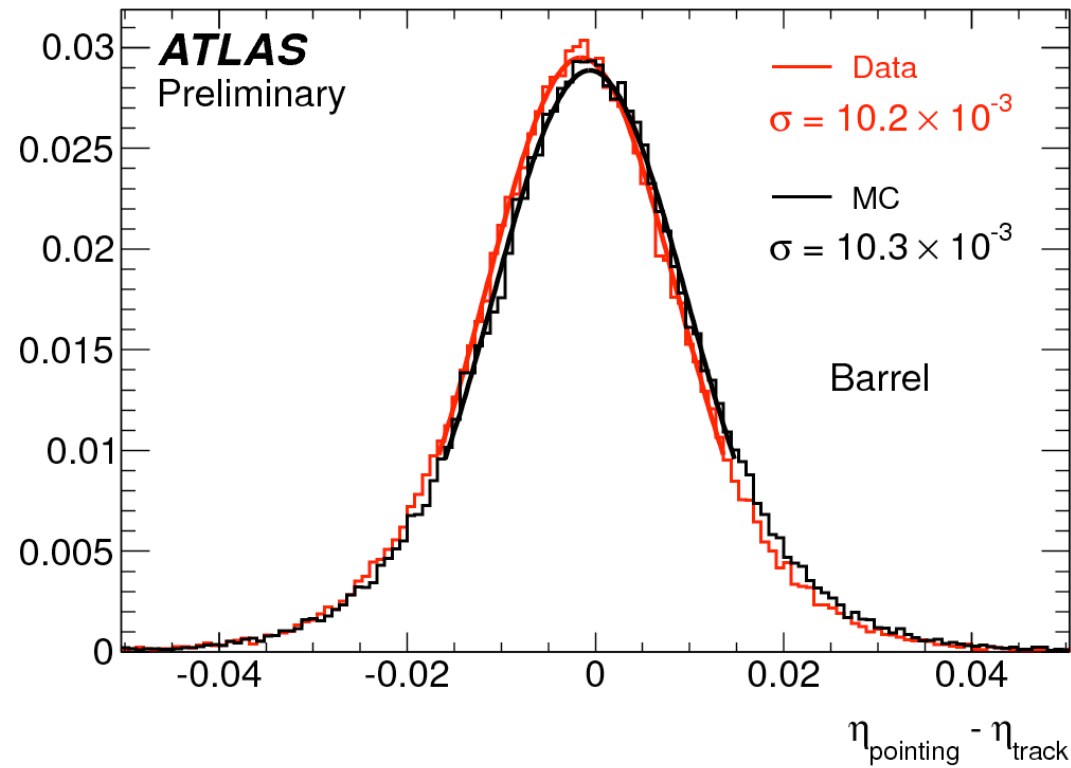

(residual systematics structure in end-cap, corrected using data later)

Compare two photons

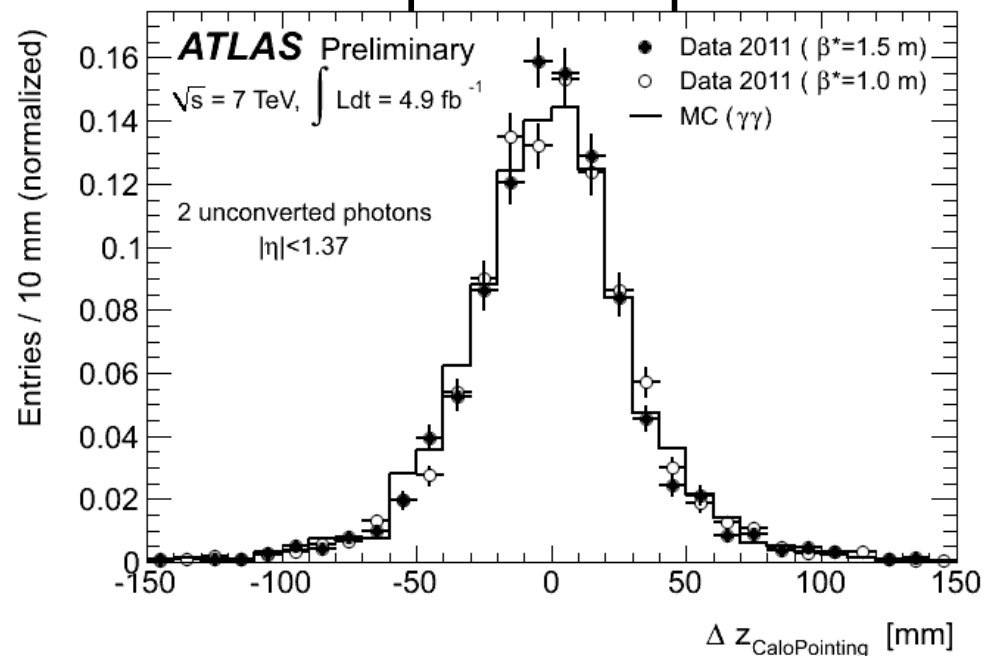

Resolution (in barrel) well modeled by simulation
 Very little pileup dependence

Pointing information good enough for mass resolution (~no impact from angle resolution on mass resolution)

For jets and tracks, need "exact" primary vertex
 => combine pointing with track informations to find most likely H production vertex

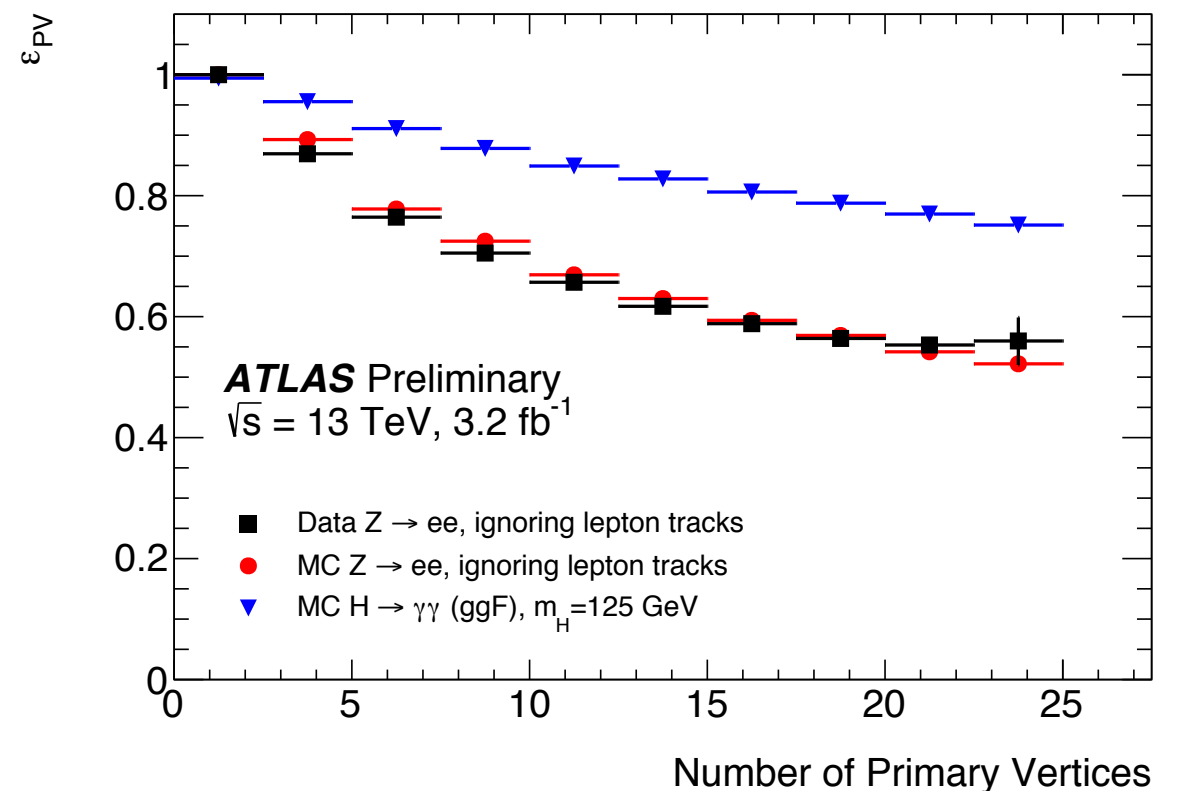
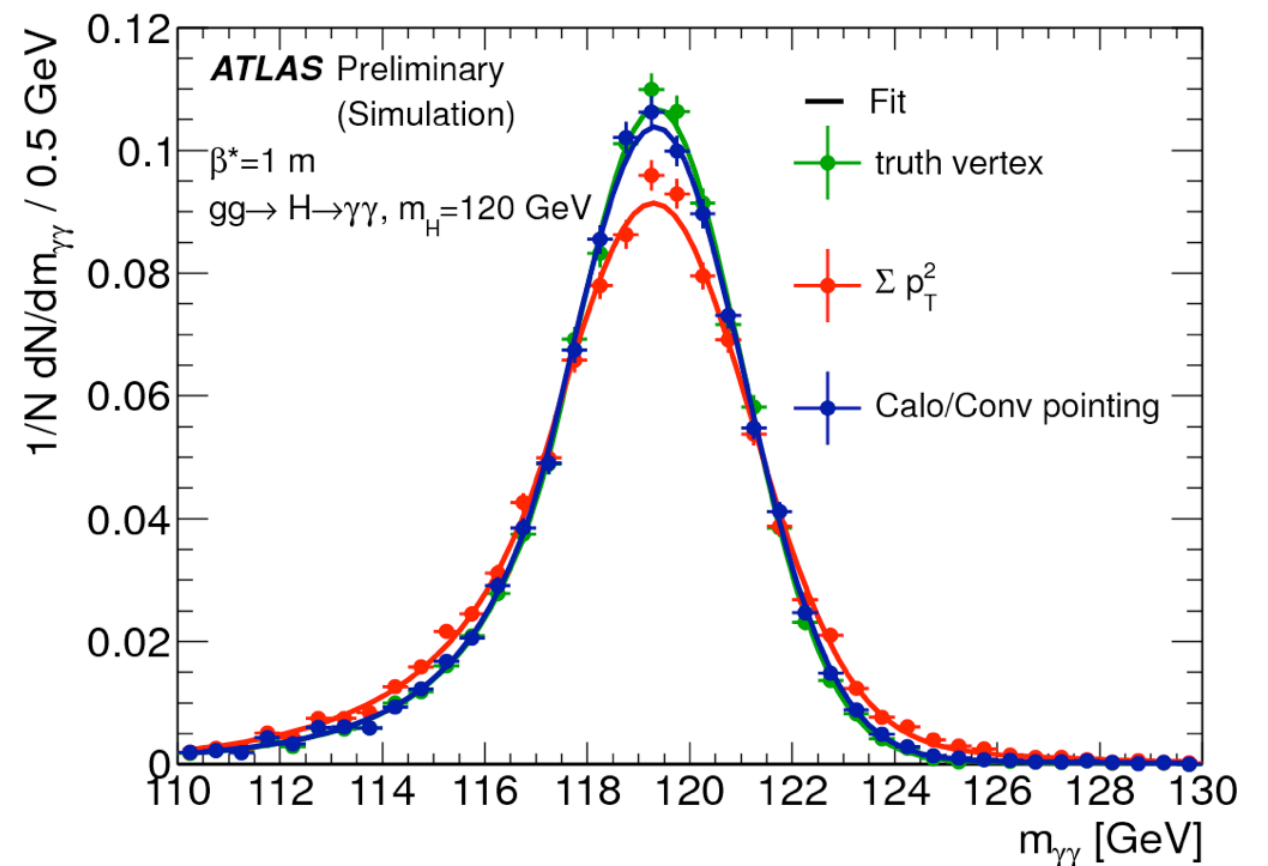

Outline

- Photon (and Electron) identification exploiting the calorimeter granularity
- Position and direction measurement with the calorimeter
- **Photon and electron energy calibration and data-driven studies**
- Application to $H \rightarrow \gamma\gamma$ analysis from 2012 to now
- Phase 1 and Phase 2 upgrades

Energy measurement

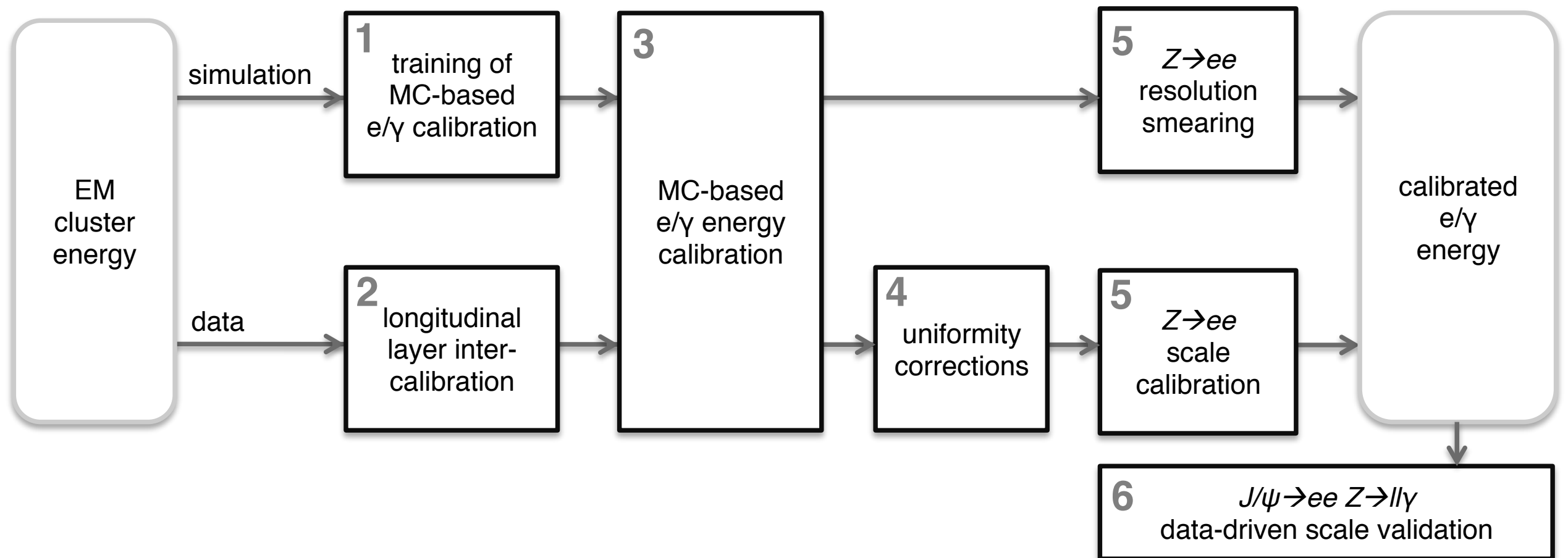

- Cell energy (from optimal filter reconstruction) from electronics calibration
- Electron/photon reconstruction from cluster of cells (fixed size or dynamic size) + track matching information
- Electron/photon energy estimate from cluster using regression algorithm trained to correct (in one go) for
 - energy lost before calorimeter and outside cluster
 - variation of energy response with impact point in calorimeter
 - Use longitudinal shower shape + position information + track information for converted photons
- Data driven adjustment/checks of input cell energy calibration, linearity and of material in front of the calorimeter
- Final energy scale adjustment using $Z \rightarrow ee$ decays, independent of energy, only done as a function of η
- All corrections are "static" with time thanks to the good stability of the response (with time, pileup, etc..)

=> "predictive" calibration that can be extrapolated to any energy, propagating uncertainties on input corrections and studies

Drawback: most accurate for ~ 40 GeV E_t electrons and not so easy to improve systematic uncertainties when moving away from this point.

Cell Energy Calibration and Measurement

from digitized 25-ns spaced (5 or 4) samples

$F_{\mu A \rightarrow MeV}$: current to energy conversion including sampling fraction, initial value from Test-Beam

R electronics gain ($ADC \rightarrow \mu A$)

P pedestal

$$E_{cell} = F_{\mu A \rightarrow MeV} \cdot M_{cal}/M_{phys} \cdot R \cdot \sum a_i (ADC_i - P)$$

M_{cal}/M_{phys} : correct bias from calibration / physics difference

a_i : Optimal Filter Coefficient to estimate pulse amplitude

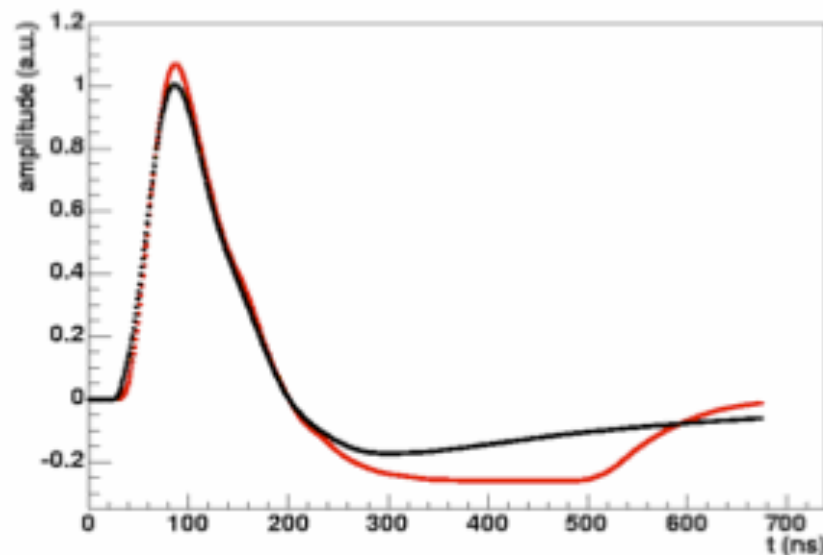

Physics pulse shape prediction and calib/physics difference extracted from detailed calibration pulse shape analysis + drift time knowledge

Correct also for non nominal HV

De-mystifying optimal filtering

- Optimal filter coefficients a_i :
 - linear estimator of amplitude from time samples which follow a normalized shape g_i (assumed to be known) + noise fluctuations
 - $\sum a_i g_i = 1 \Rightarrow$ unbiased estimated of amplitude
 - $\sum a_i g_i' = 0 \Rightarrow$ insensitive to time jitter at first order
 - $\sum a_i a_j R_{ij}$ minimum (R_{ij} = correlation of total noise) \Rightarrow minimize noise
 - From these constraints a_i coefficients can be computed
- Use 5 (run 1), 4 (run 2) time samples (L1 trigger rate increase)
- R_{ij} computed assuming pileup with 25-ns bunch spacing and 20 interactions per crossing during full run 2
 - Changes wrt to optimum a_i (pileup) small for pileup range of run 2
 - Keeping same set of a_i is better for stability of energy scale

Test beam experience to learn many aspects of pulse reconstruction (optimal filter coefficients, electronics calibration to physics extrapolation), energy estimate procedure, etc..

linearity

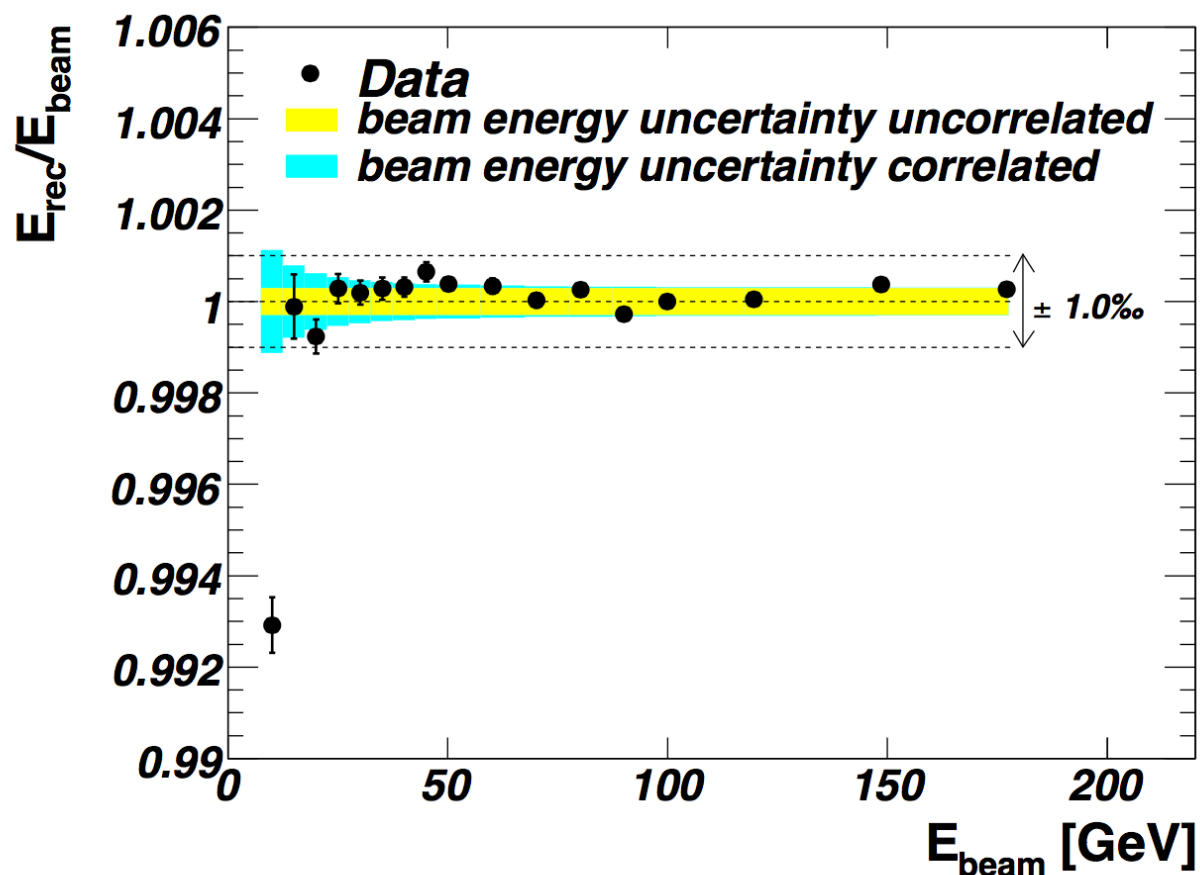

uniformity

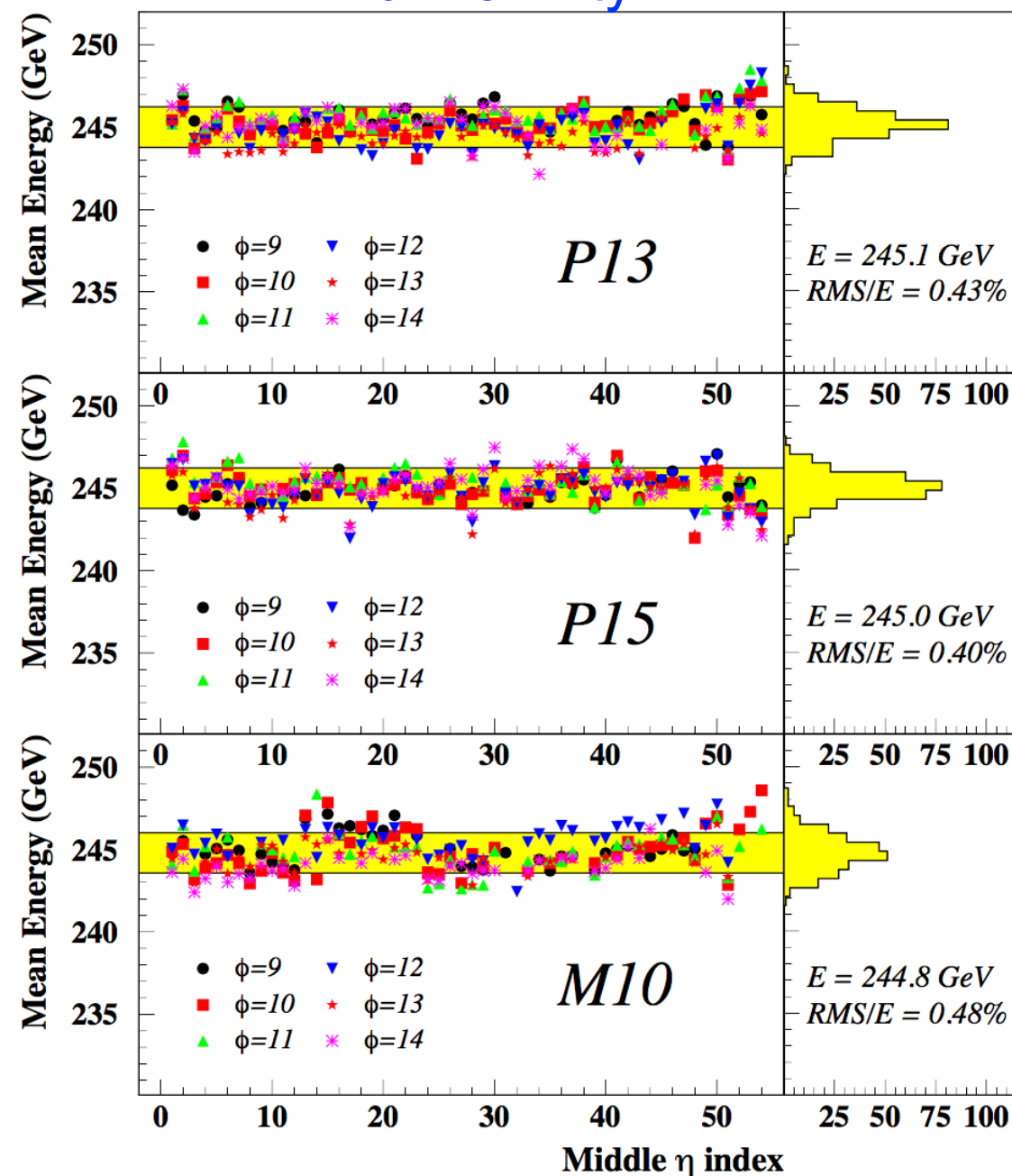

Regular electronics calibration run (between LHC fills) to monitor stability (and update when needed) of the readout electronics

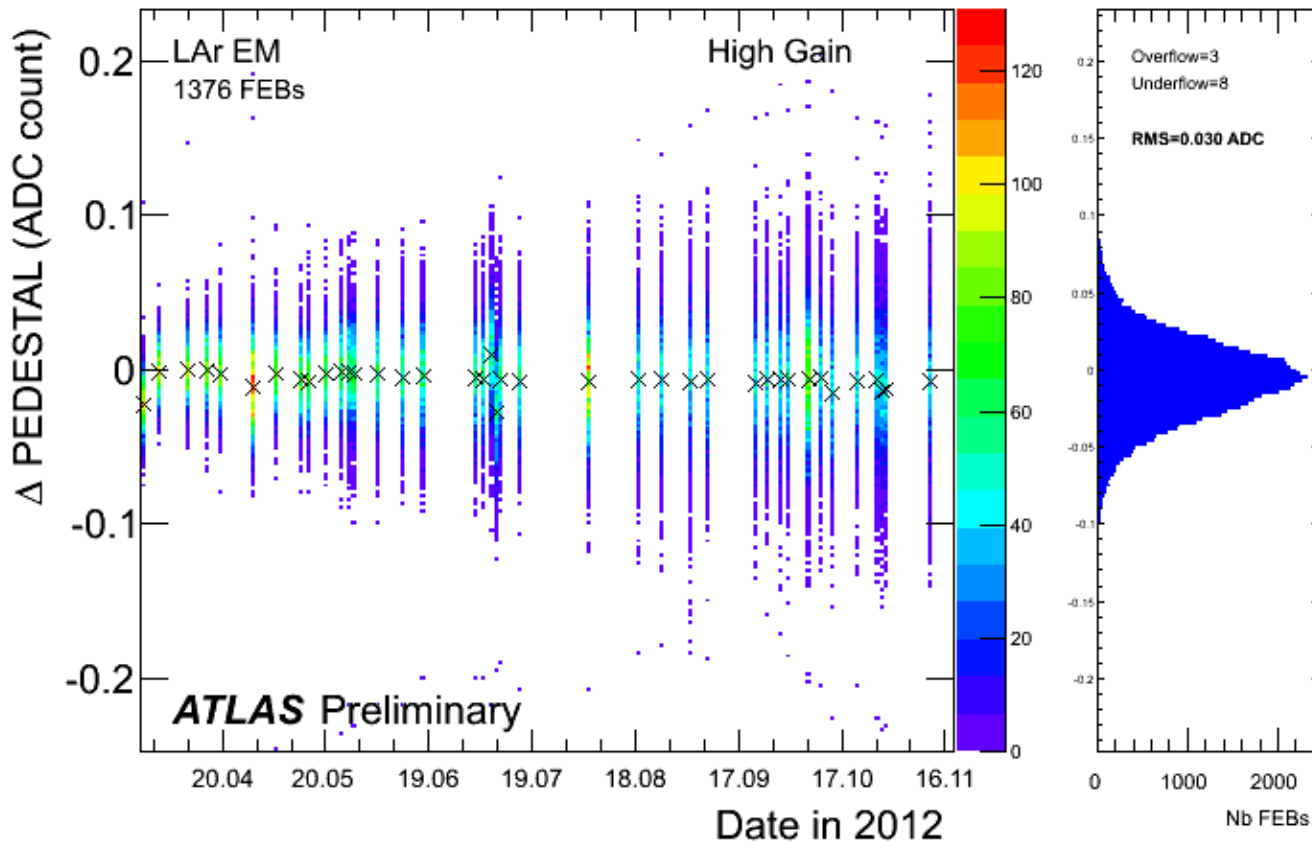
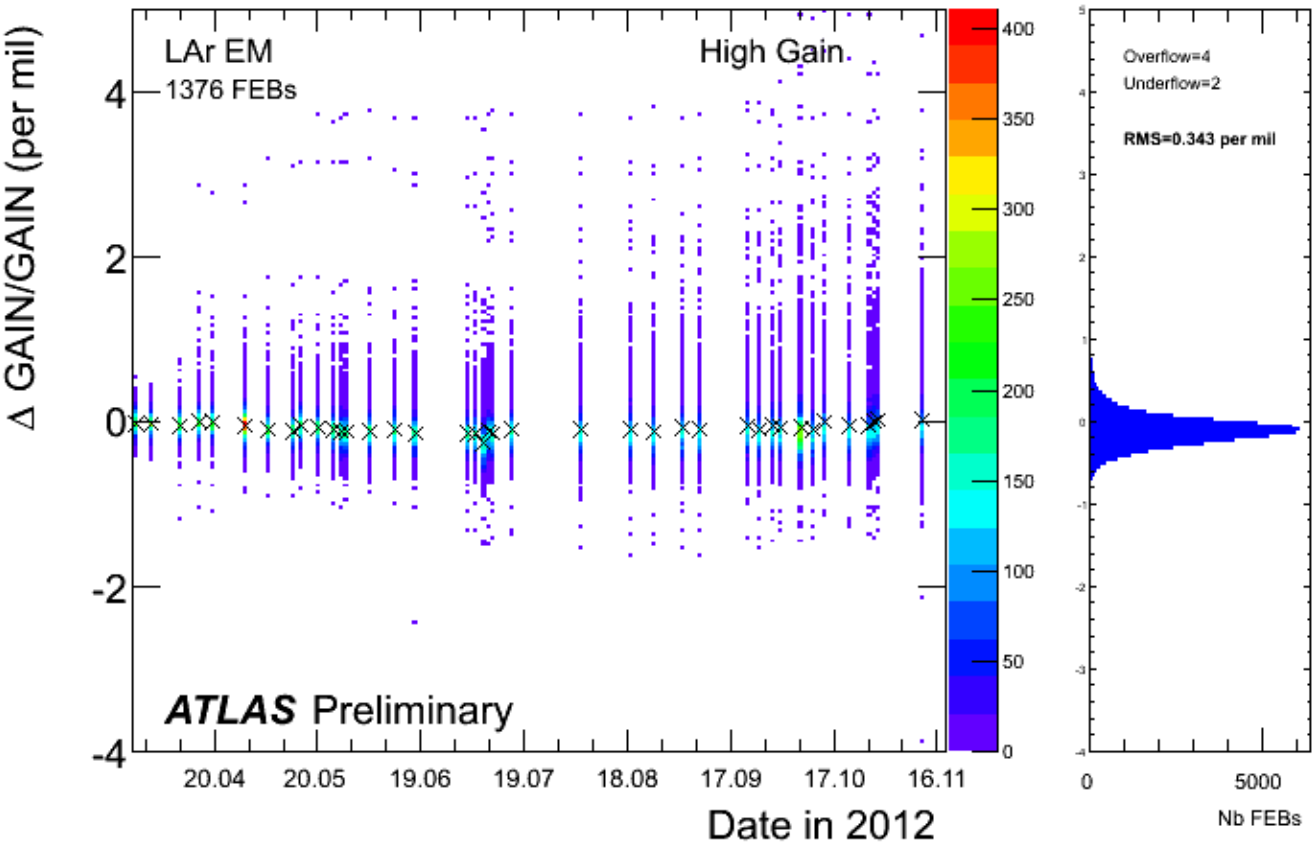

MC based regression algorithm for e/gamma energy estimate

For unconverted photons get \sim intrinsic sampling term of calorimeter resolution (10%/sqrt(E) in barrel)

Worse resolution for converted photons due to energy lost before the calorimeter and opening of e+e- pair in B-field

Rely on proper geometry description the MC

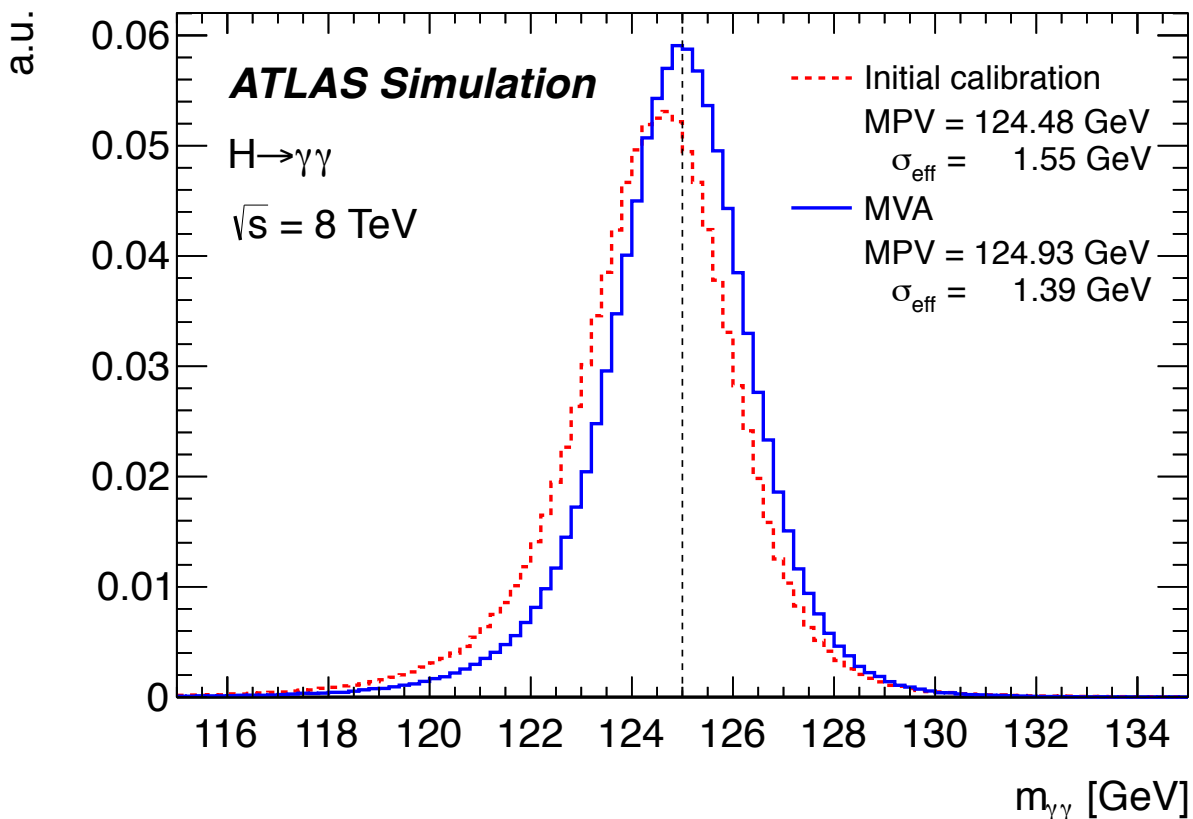
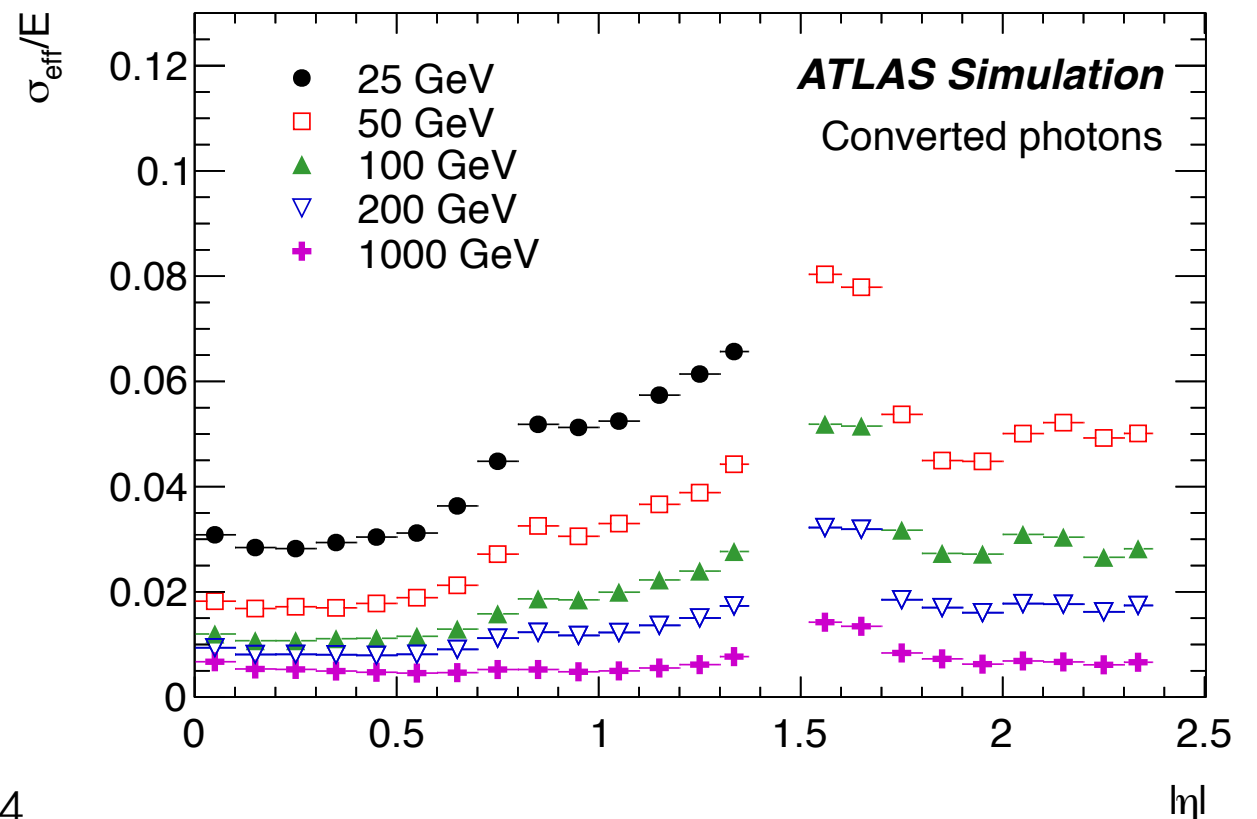
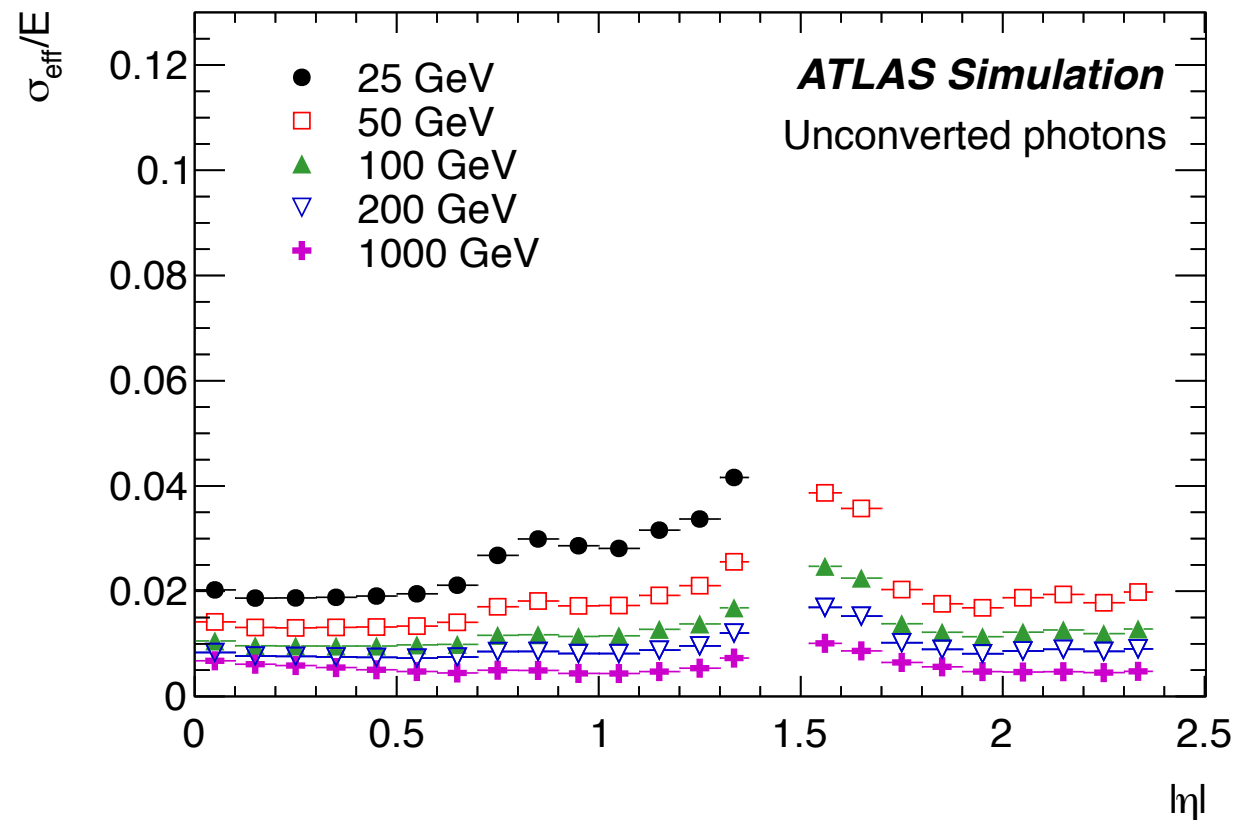

Data driven studies and corrections

- Intercalibration of the different longitudinal layers: required for good linearity of the calibration and $e \rightarrow$ photon extrapolation
- Understanding of the material in front of the calorimeter
 - Material in ID active area ~well known (5%)
 - Not the case for some of the services between the ID and the calorimeter. Also tricky to implement in simulation
 - Was studied in details with run 1 data, most conclusion still applies to run 2
- Linearity of the cell energy calibration
- Pileup and luminosity effects

Relative calibration of layer 1 and layer 2

Use muons to be insensitive to material in front of calorimeter

Complication: small S/N especially for data taken with high-pileup in the end-cap

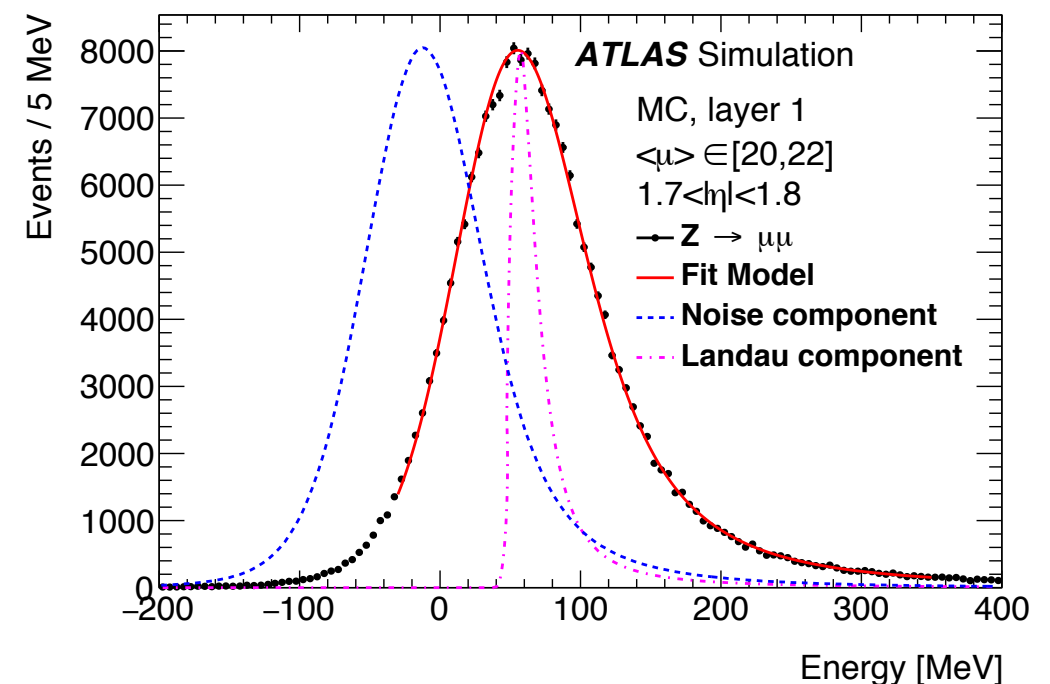
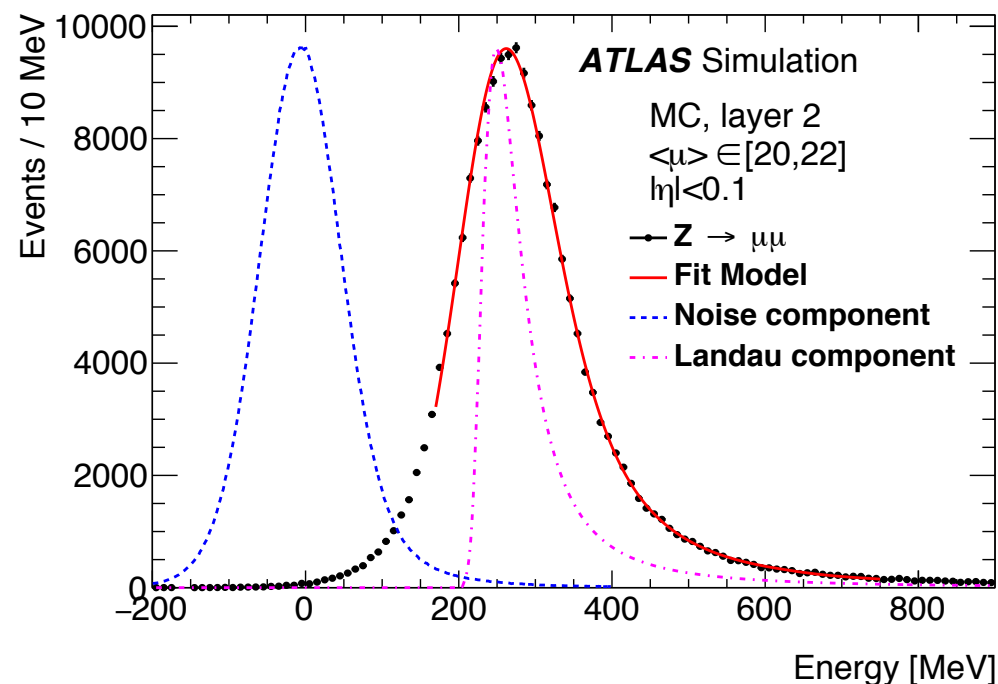
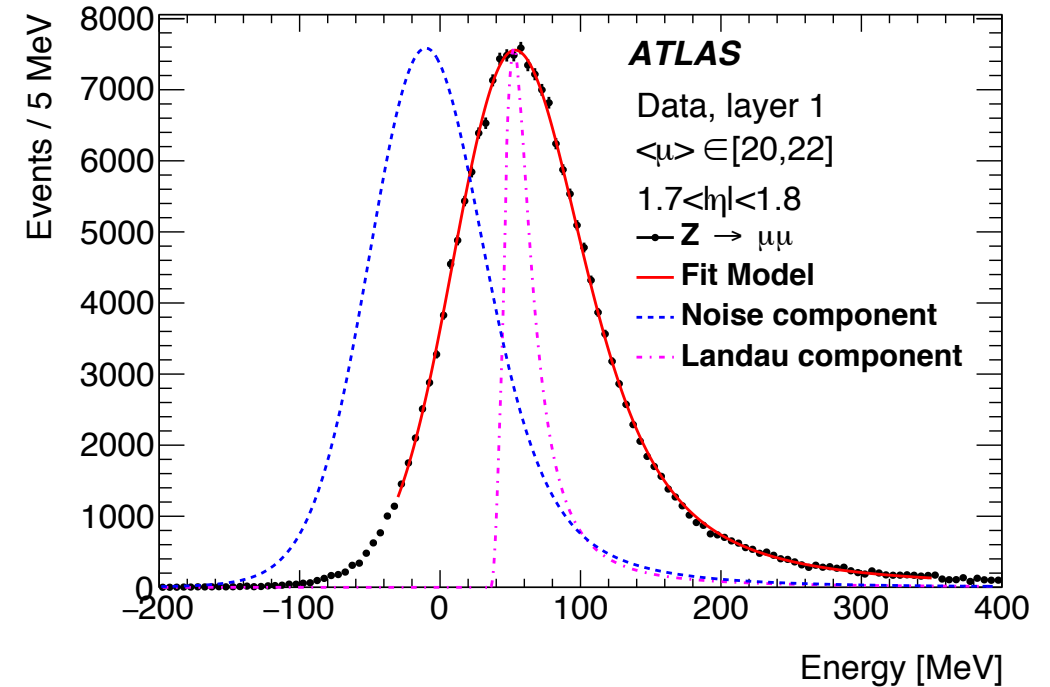
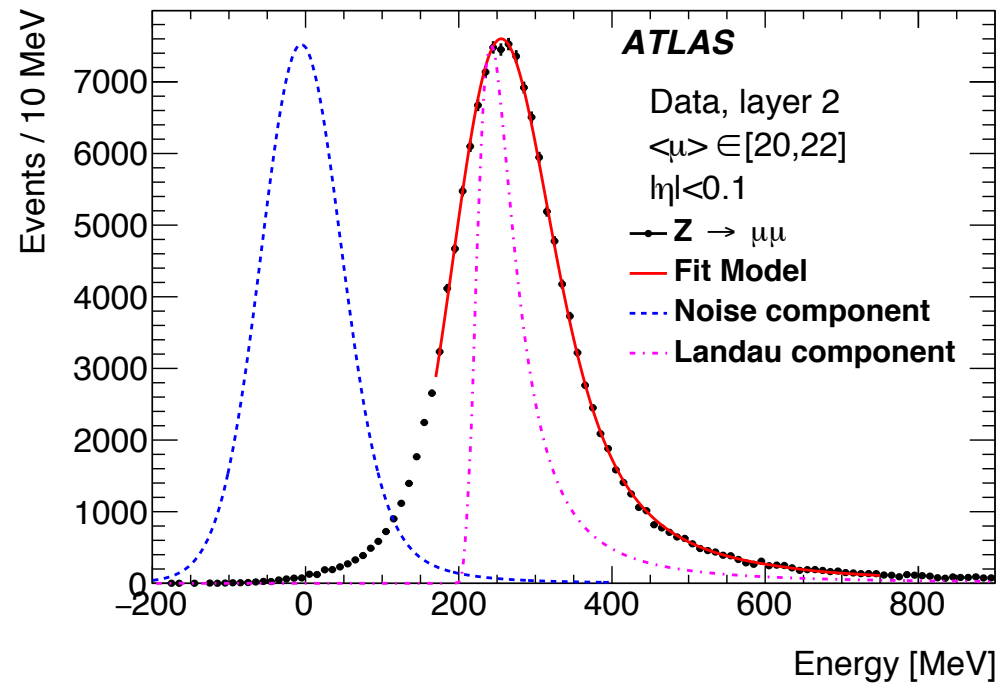

Extrapolate to 0 pileup to get "intrinsic" calibration

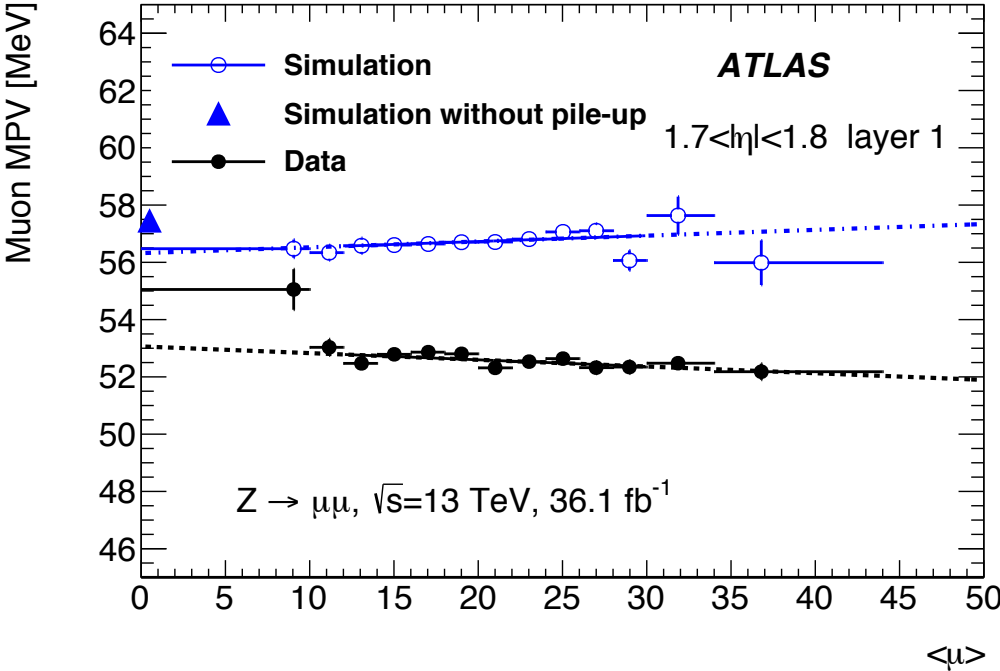
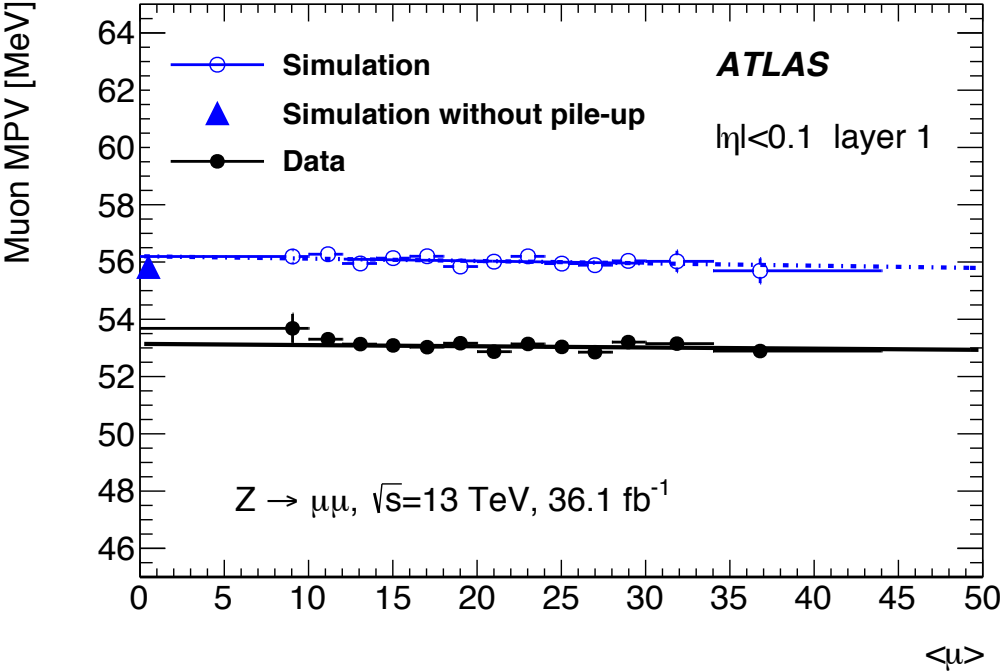

Result =>

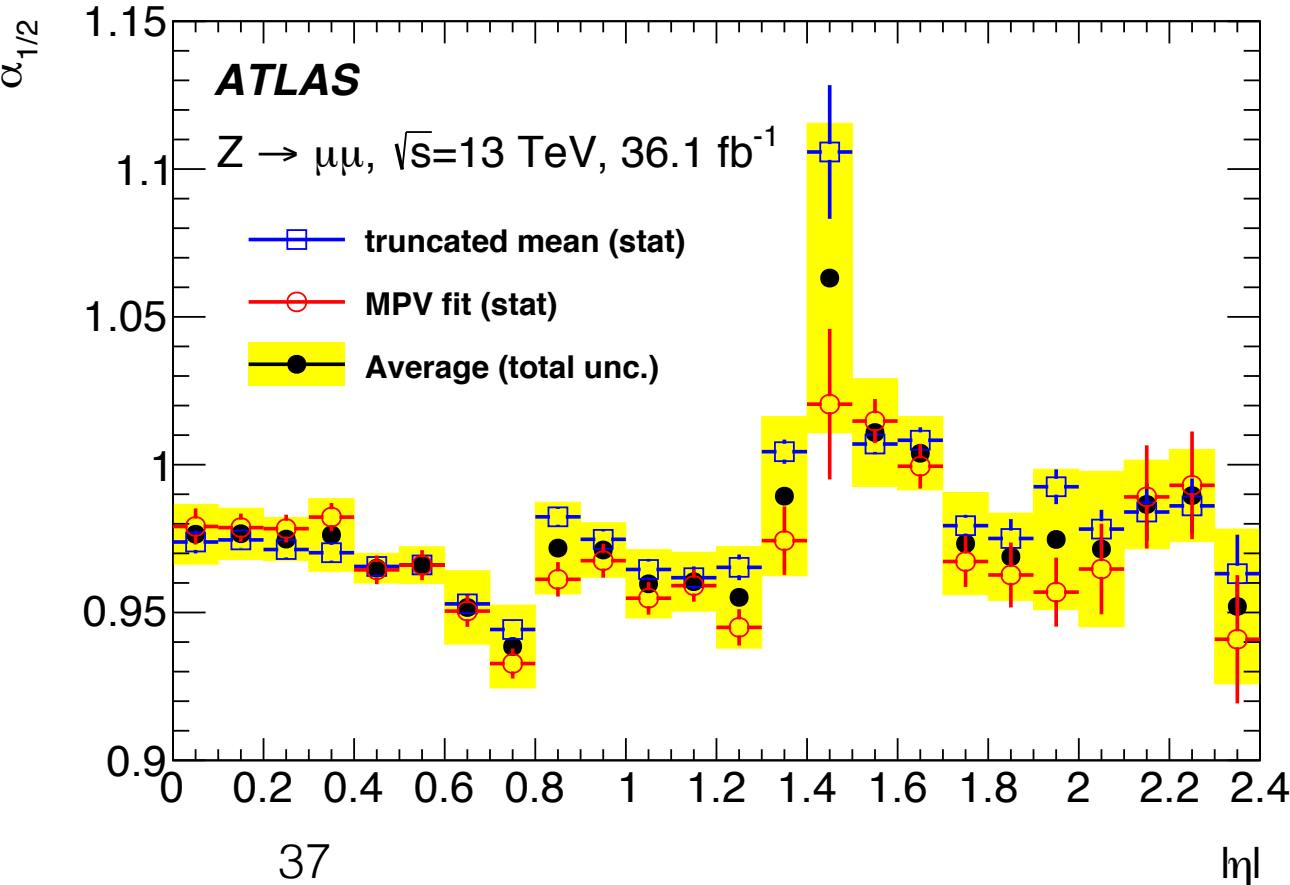

To interpret the muon data/MC as a "genuine" calibration, relies on exact description in the MC of dE per cell of muons

=> impact of geometry (path length, cross-talk effects, etc..)



~ 1% systematic uncertainty on E1/E2 calibration

Example of EMB electrode $\eta < 0.8$ near L1-L2 transition

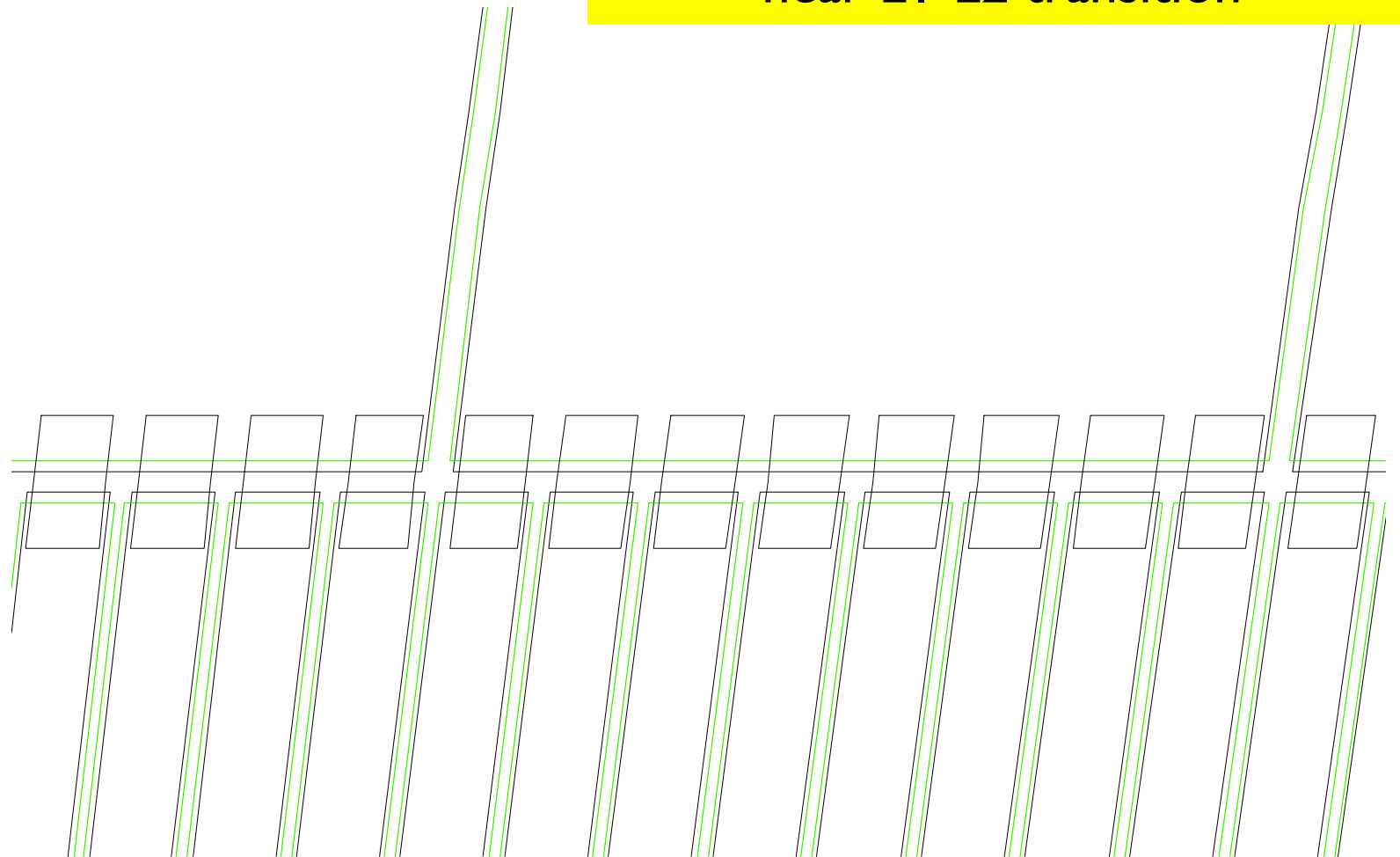

Procedure for presampler (E0) calibration

A bit more tricky

Use data/MC E0 for electrons: sensitive to both genuine presampler calibration and upstream material

Remove the effect of upstream material by correlating with E1/E2

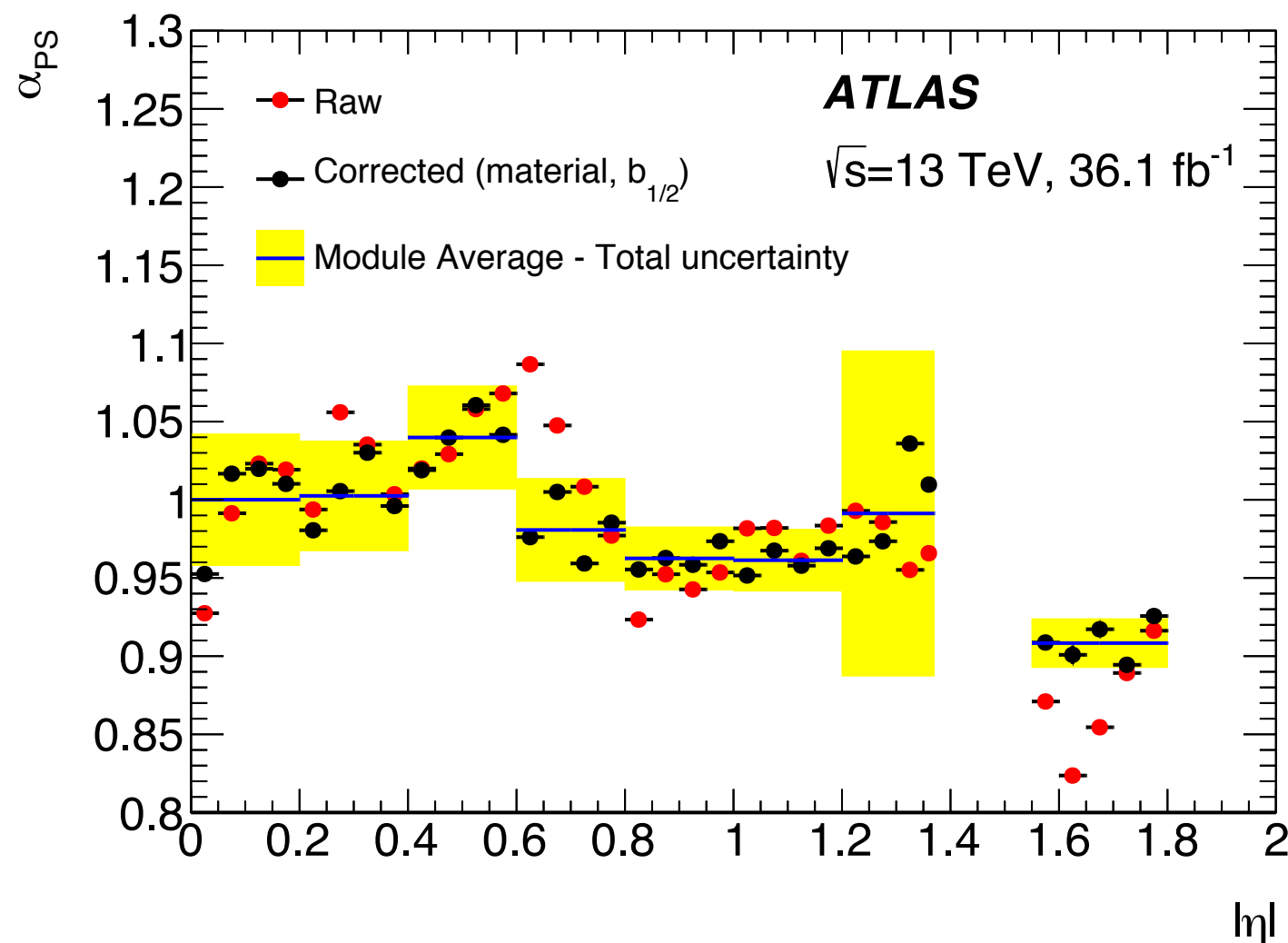

Linearity of cell energy calibration

Expect $< 0.1\%$ effect from genuine non linearity of electronics but could not exclude larger effect in the relative calibration of different readout gains (medium gain vs high gain)

Transition is somewhat in between $Z \rightarrow ee$ and $H \rightarrow \gamma\gamma$

Took special data in 2015, 2017 and 2018 with lower gain transition threshold so study this effect

Up to 0.4% effect in some regions
=> taken as systematics

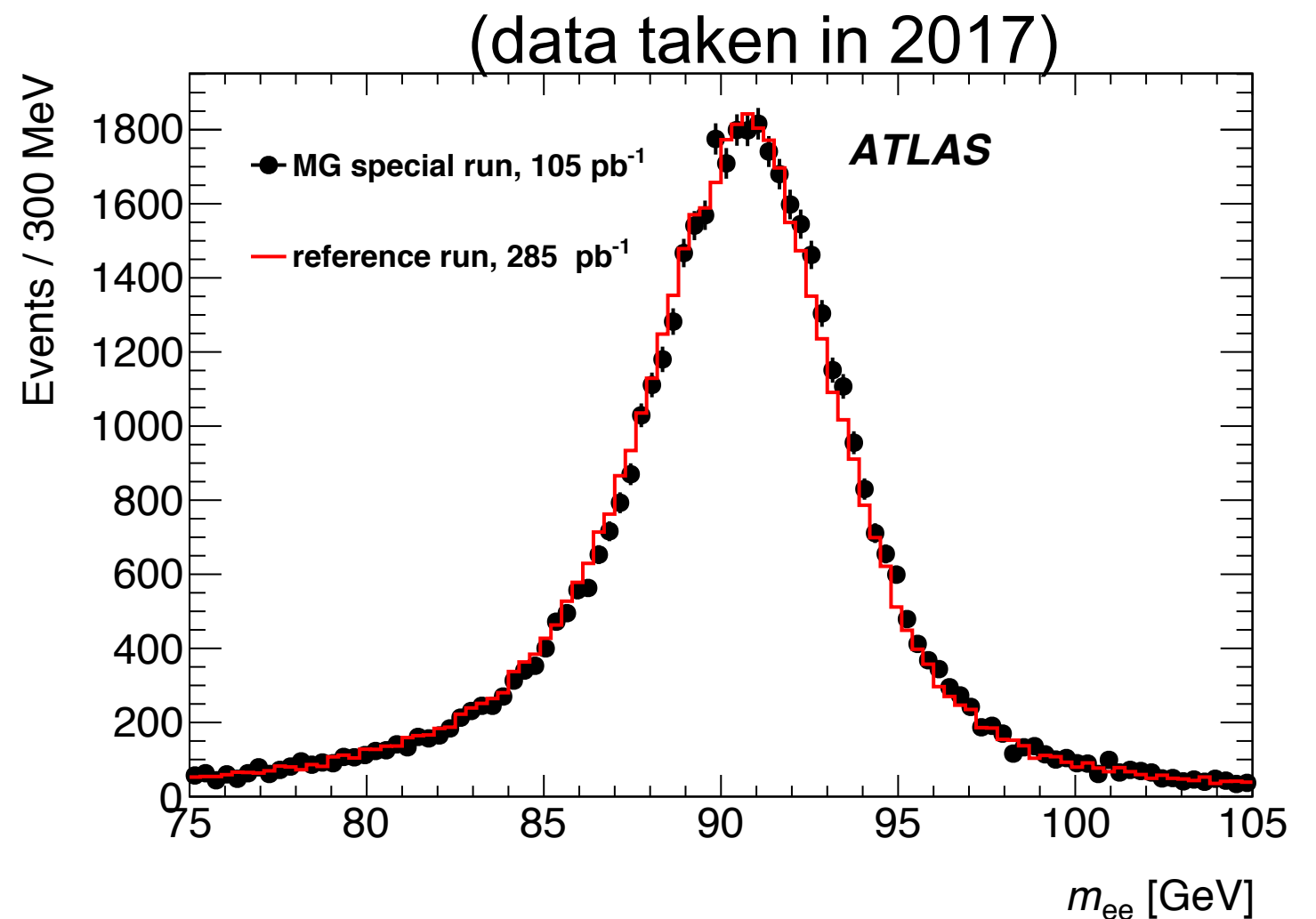

Pileup effects on calorimeter energy measurement

Bunch structure => no ideal cancellation of average pileup=> need correction (otherwise up to more than 500 MeV E_T shifts for run 2 pileup)

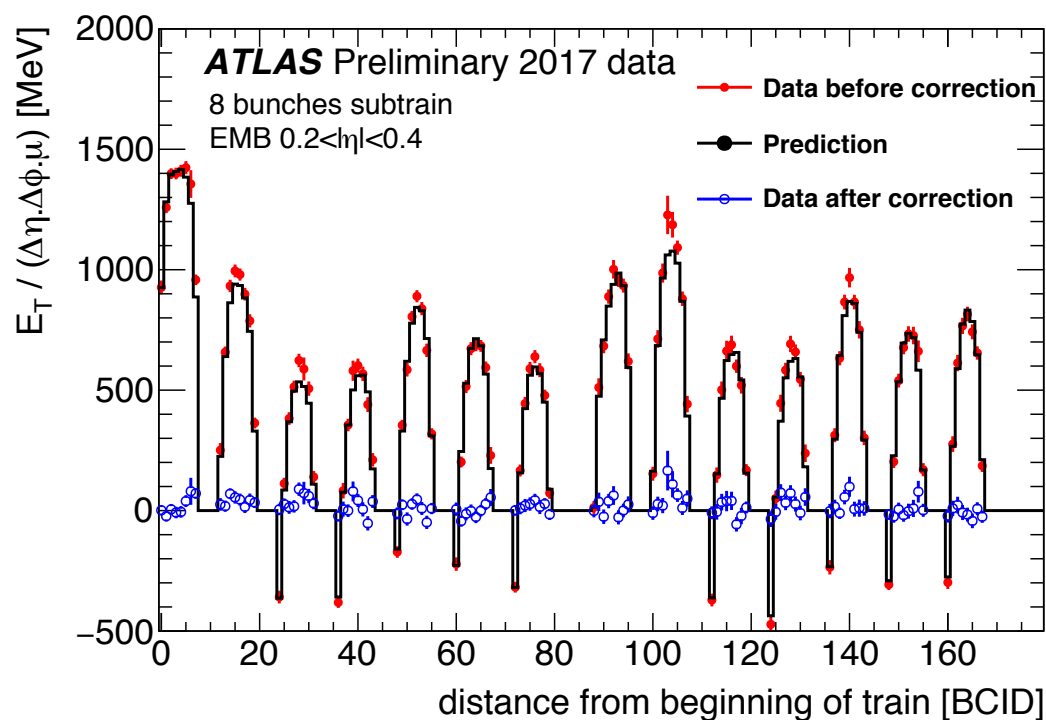
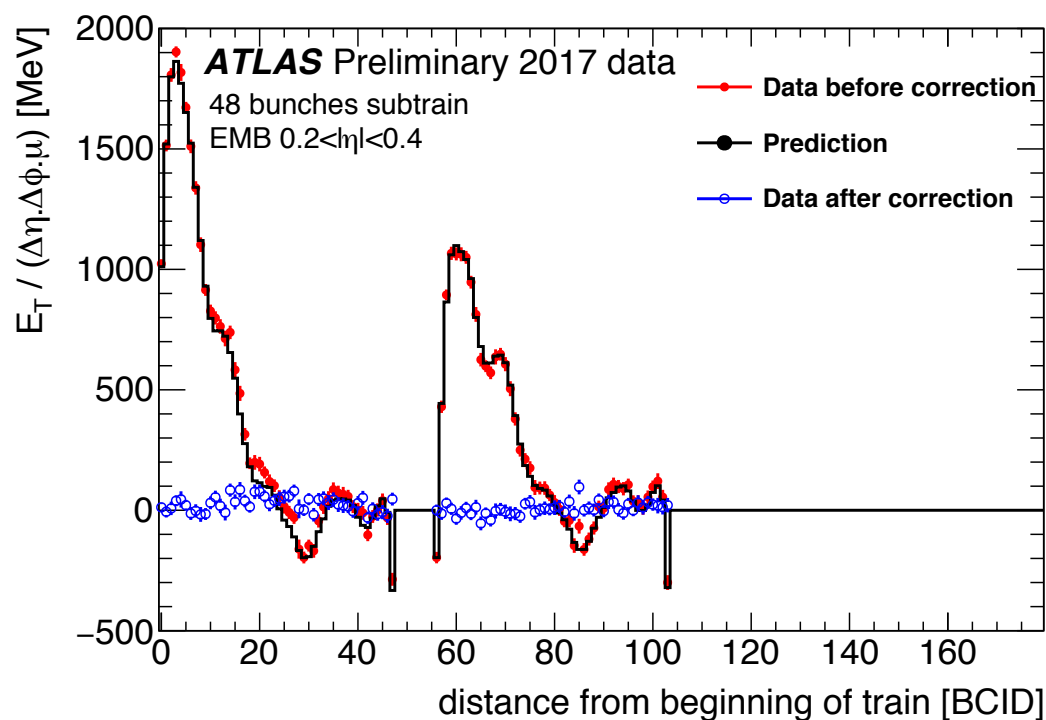

Pileup fluctuations => "noise" in E_T scales with $\sqrt{\text{pileup}}$
~90 MeV* $\sqrt{\text{pileup}}$ for photon cluster typically

Difficult to mitigate event-per-event

(total noise per cell)

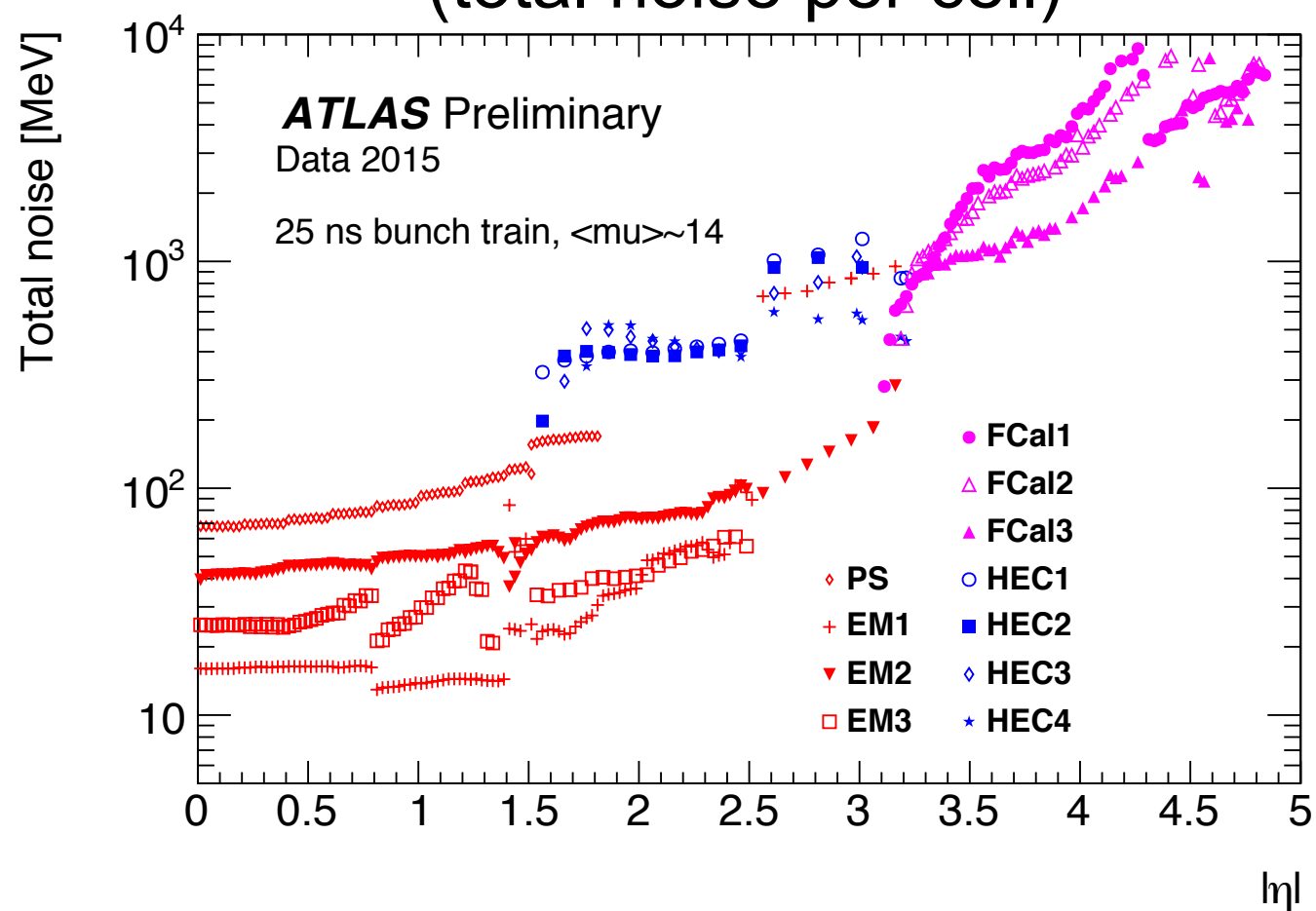

Luminosity effects on calorimeter response

Steady flux of particles from pp collisions:

- heating of the calorimeter through energy deposit => change of energy response (-2%/K)
- steady state current flowing through the HV system (up to $\sim 100 \mu\text{A}$ per HV line near $\eta \sim 2.5$) leading to voltage reduction between power supply and detector

=> Effect \sim few per mill on the EM endcap calorimeter

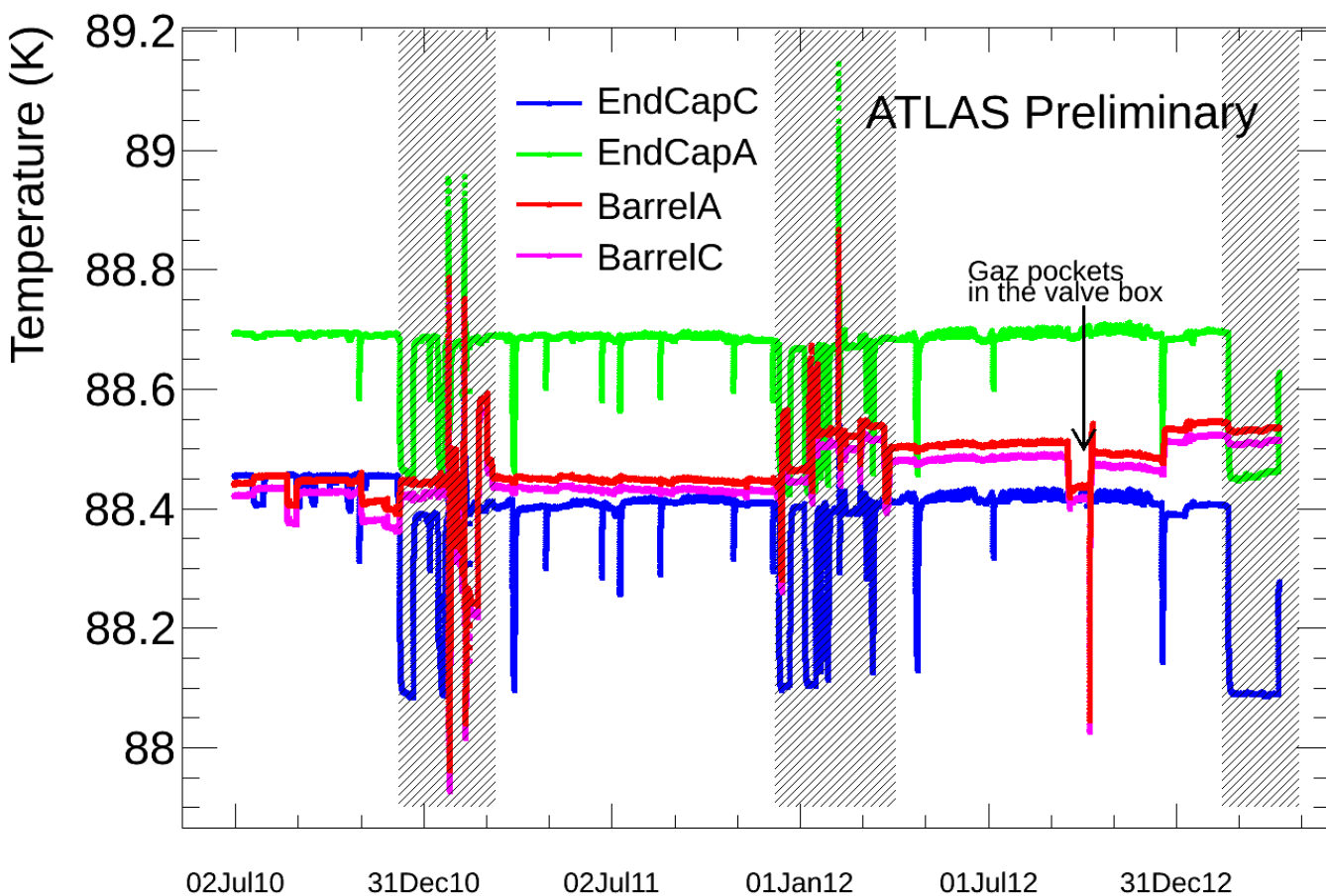

energy scale difference 2016-2015

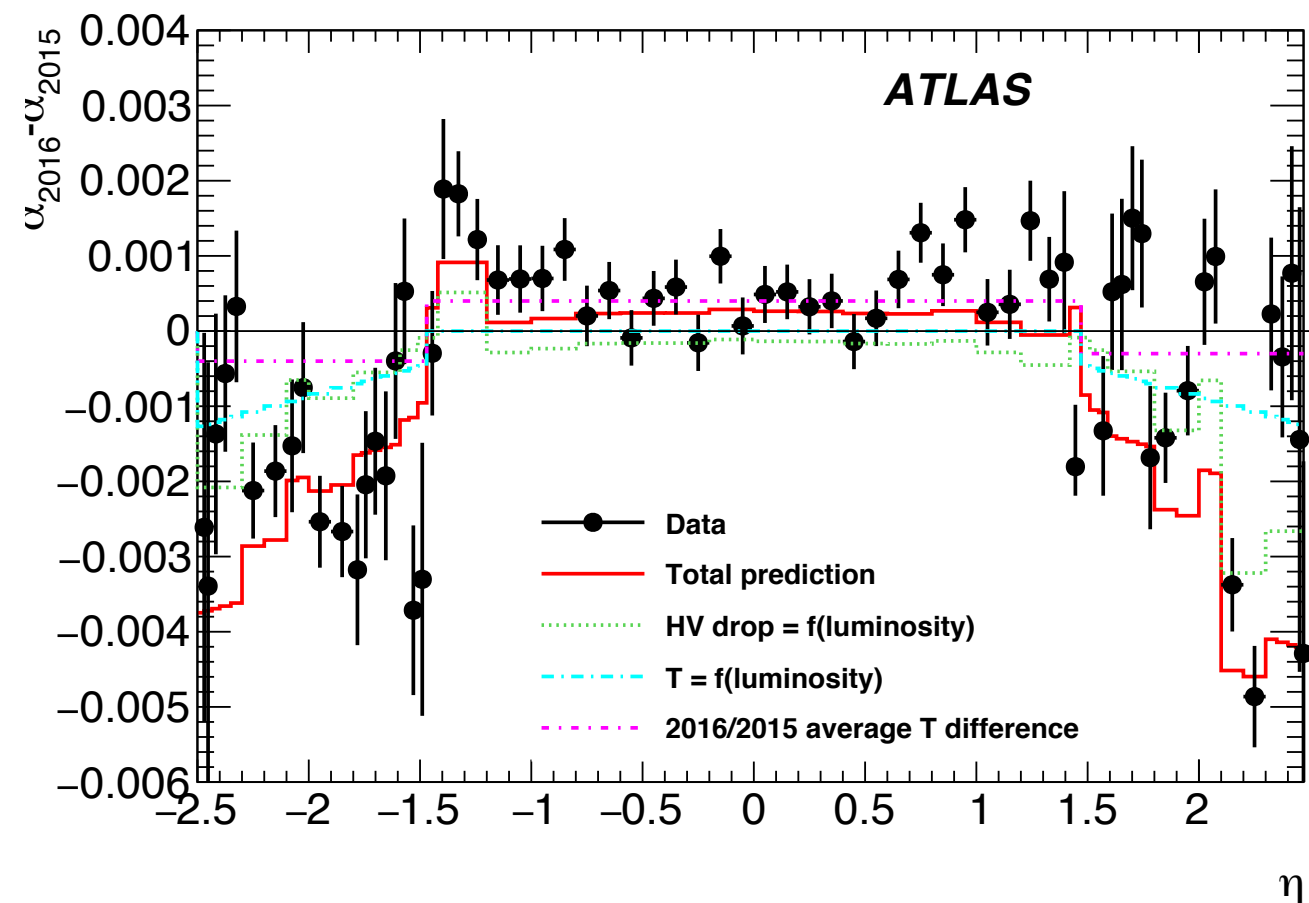

but overall the energy response is still very stable with pileup and time....

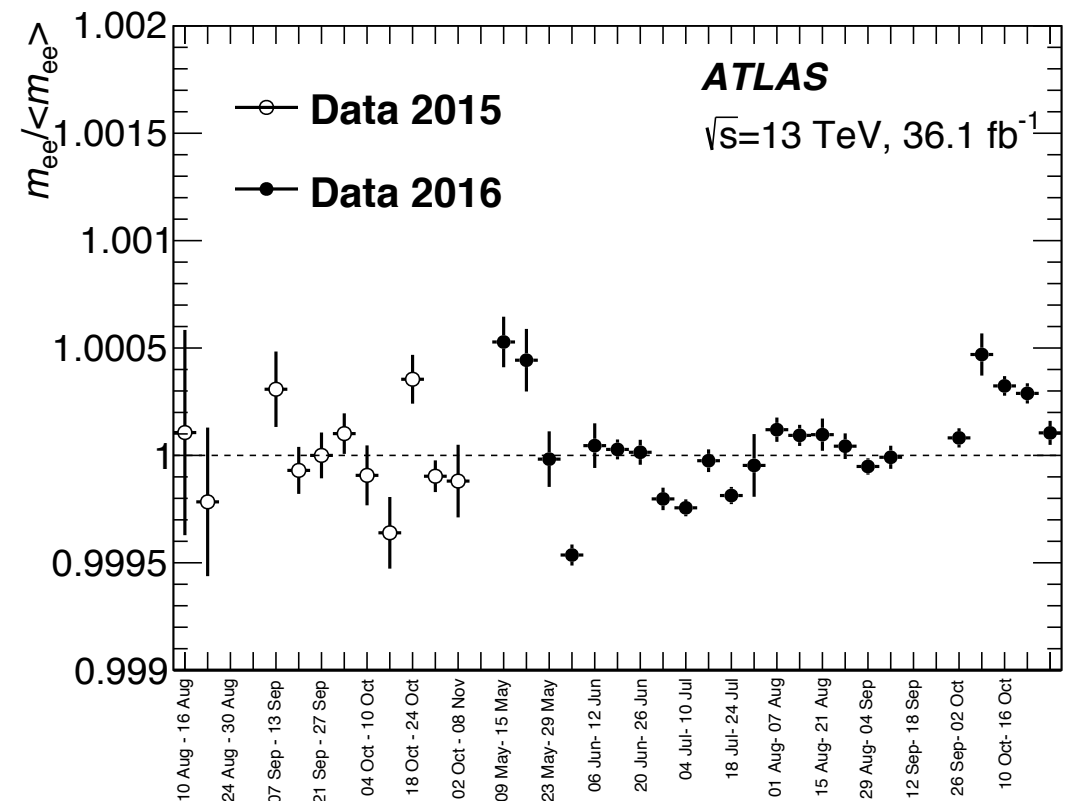
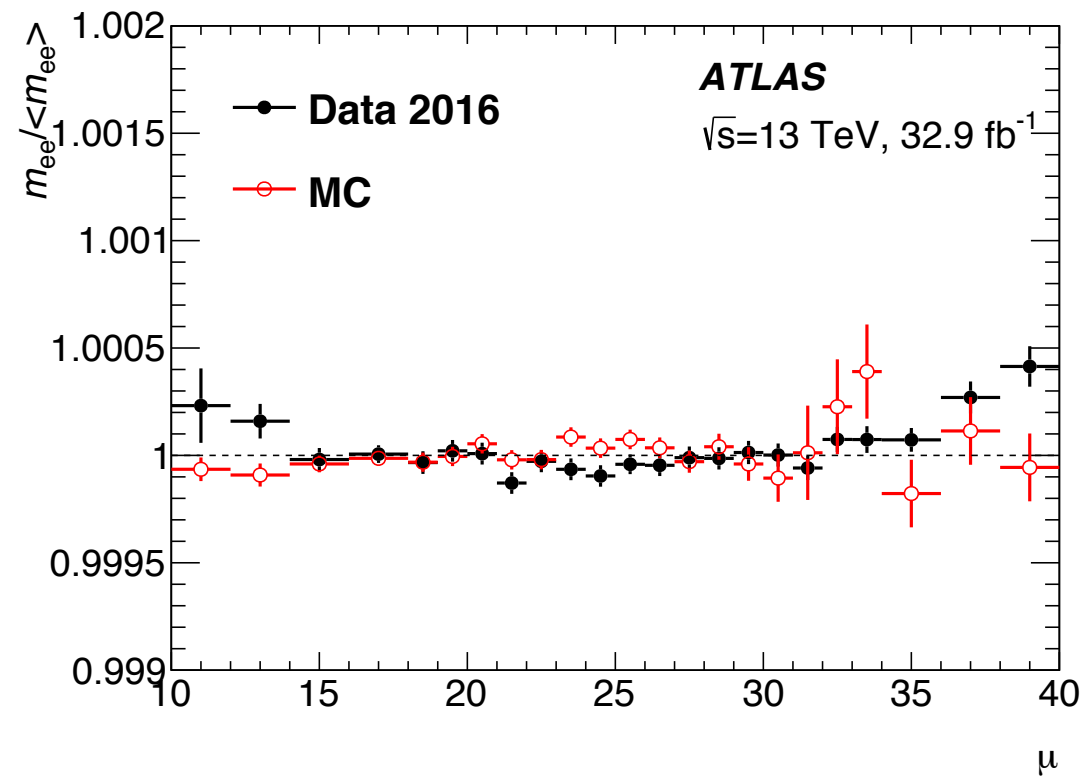

Final energy scale adjustment with $Z \rightarrow ee$

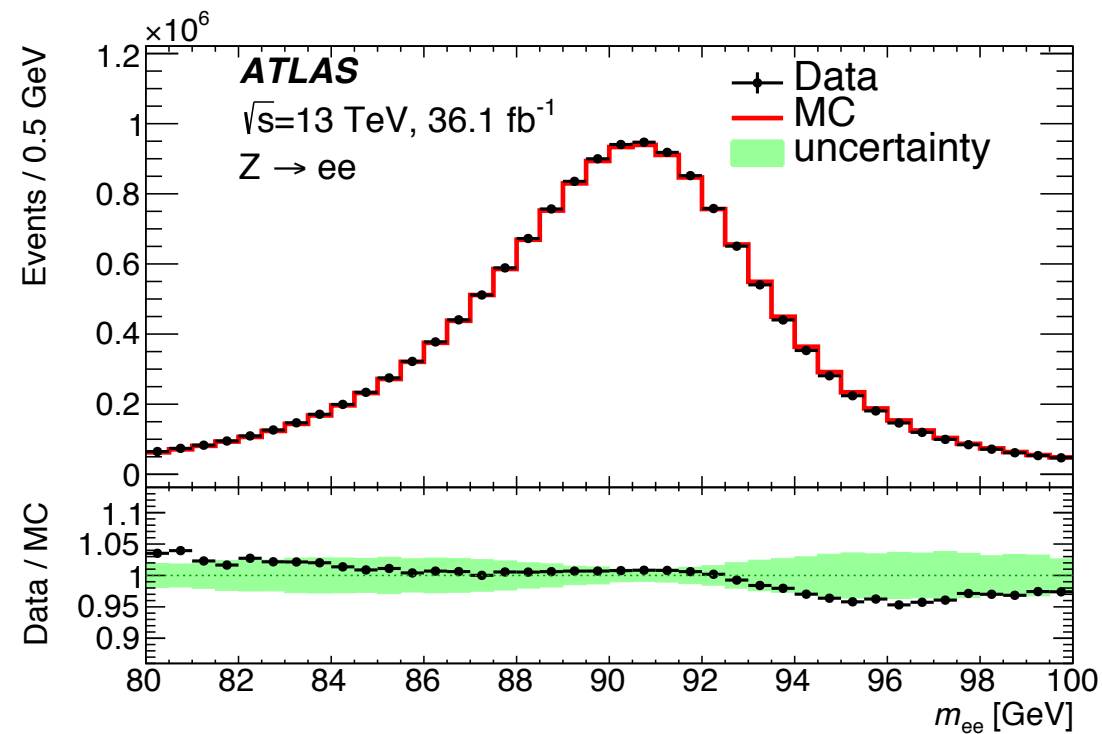

Energy scale correction
for data = f(η)

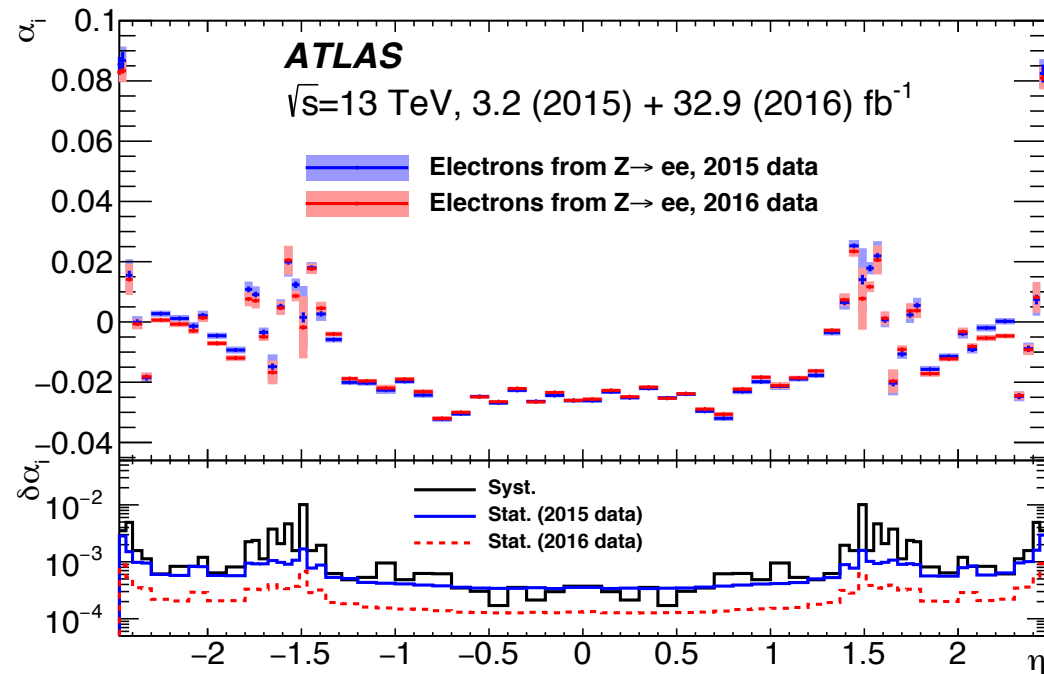

Extra constant term to apply to MC
to match data resolution
=> this is close to design 0.7% in barrel

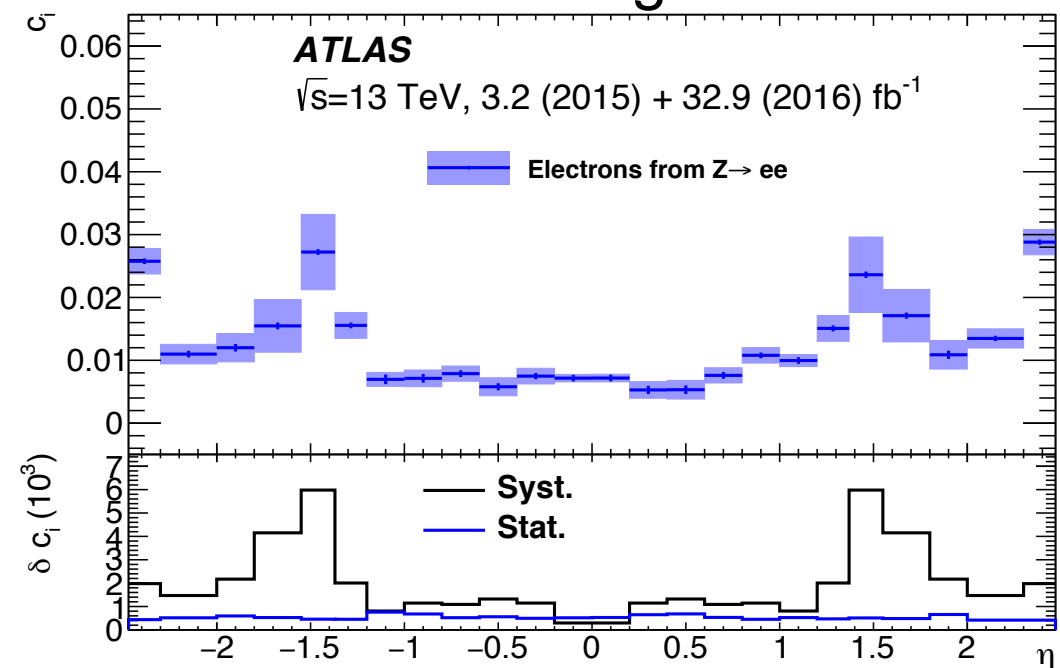

Contribution to constant term from non uniformities (vs phi)

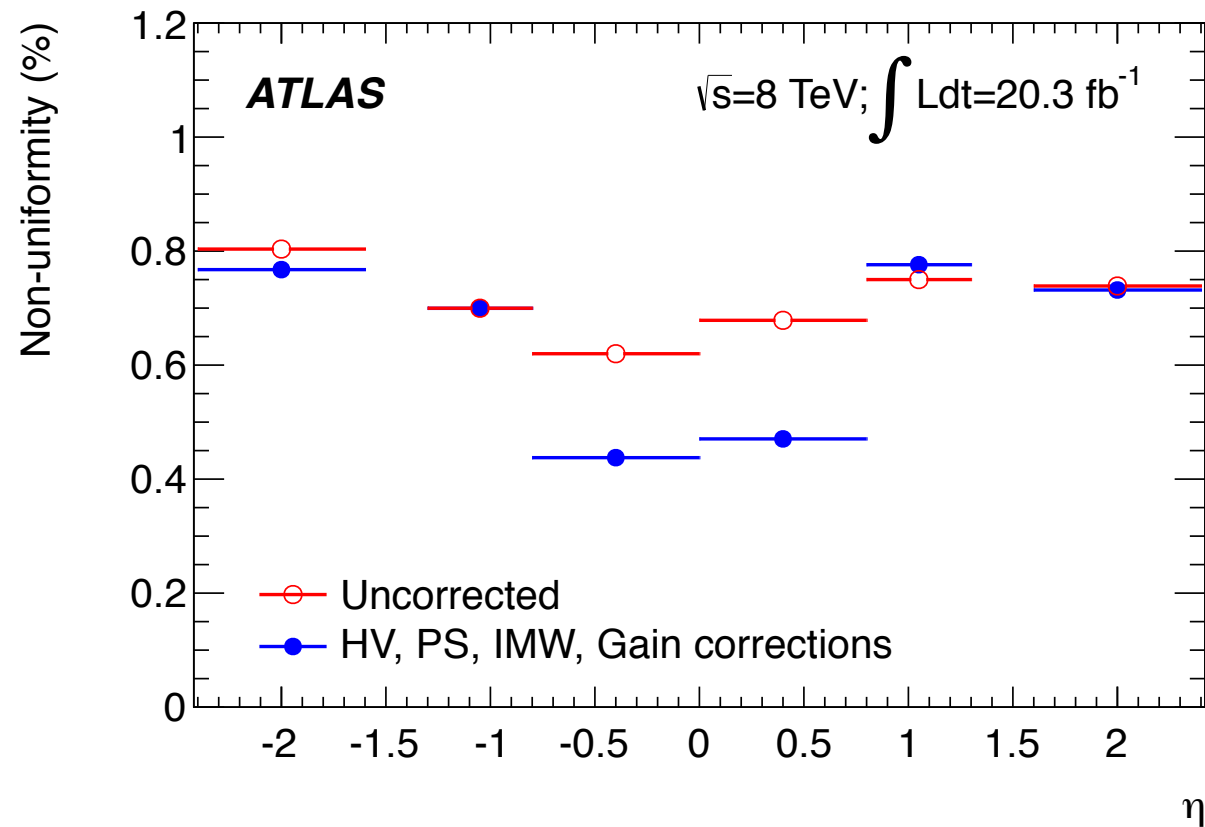

In end-cap, $\pm 2\%$ peak-to-peak drift time variation
 $\Rightarrow \pm 0.5\%$ on energy

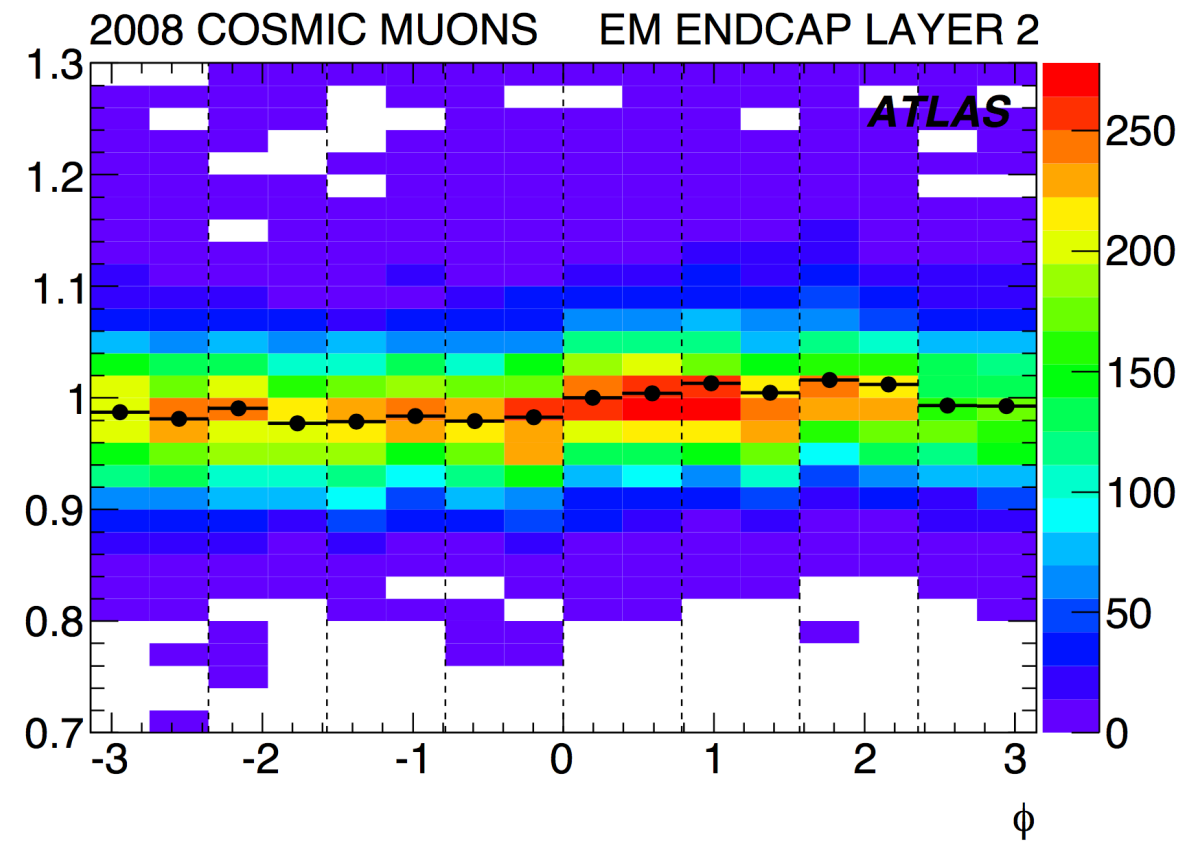

\Rightarrow some room to improve a bit the constant term

Cross-checks

Use independent samples of $J/\psi \rightarrow ee$ and $Z \rightarrow ll\gamma$ to check calibration

=> In agreement within systematics

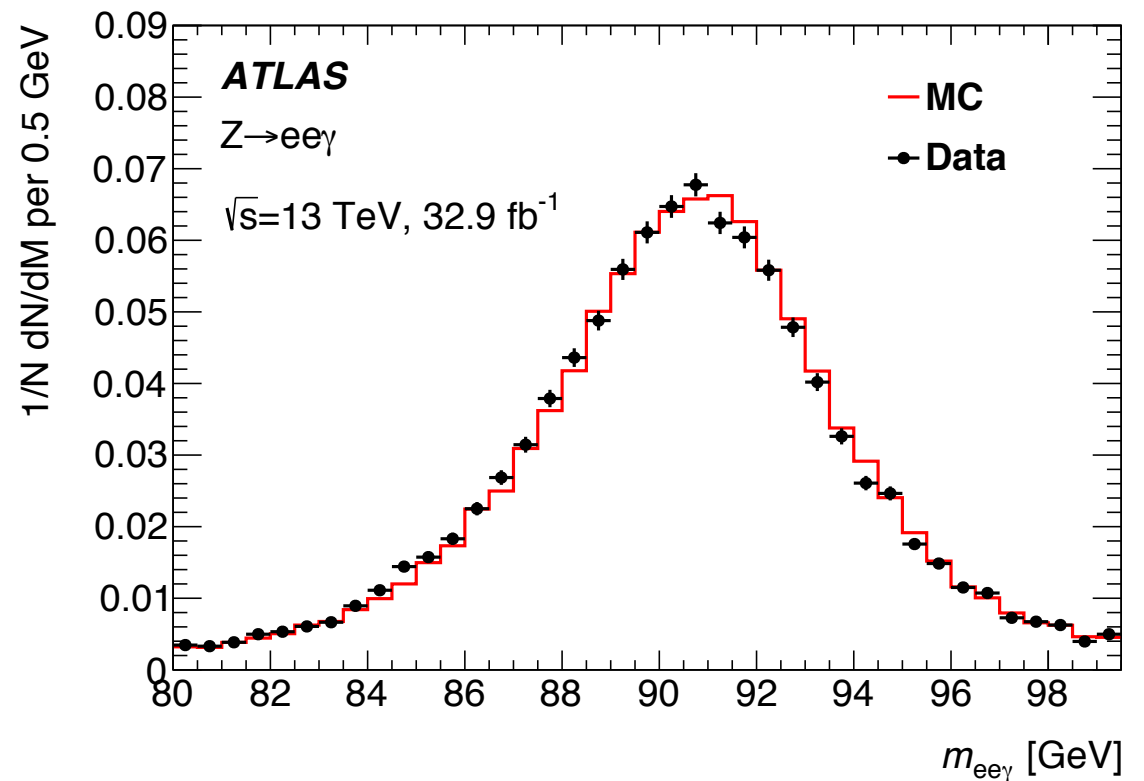
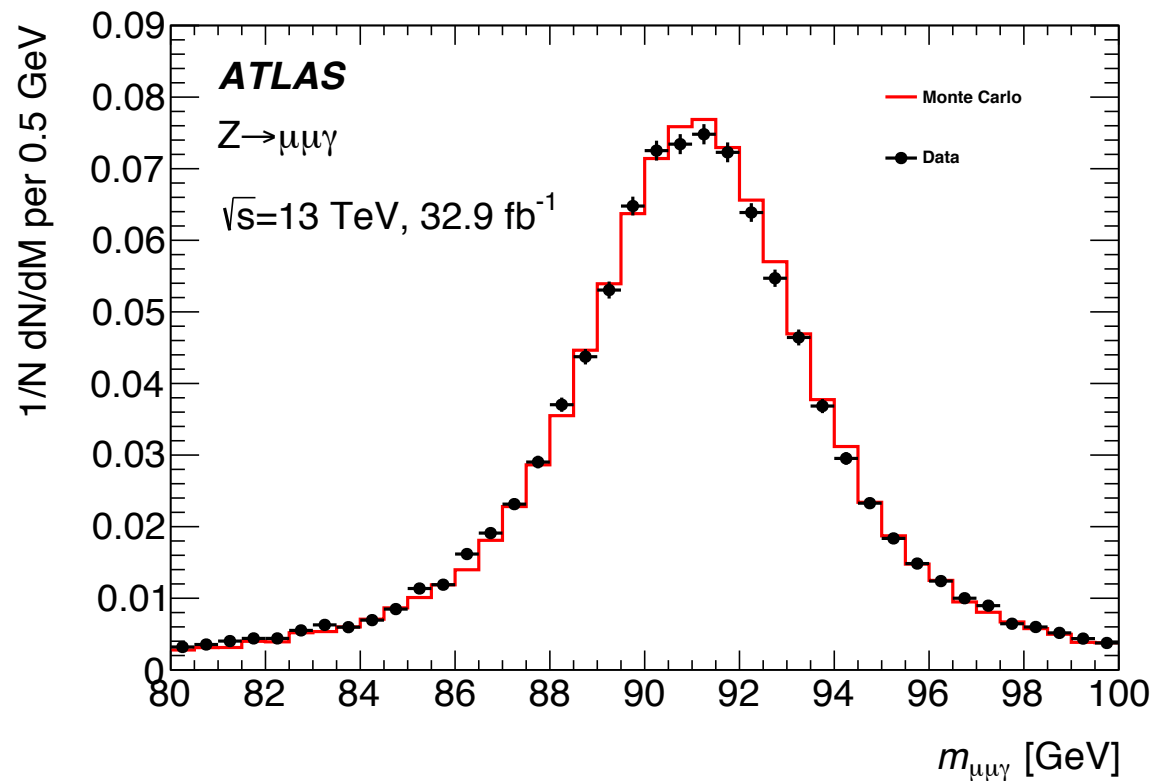
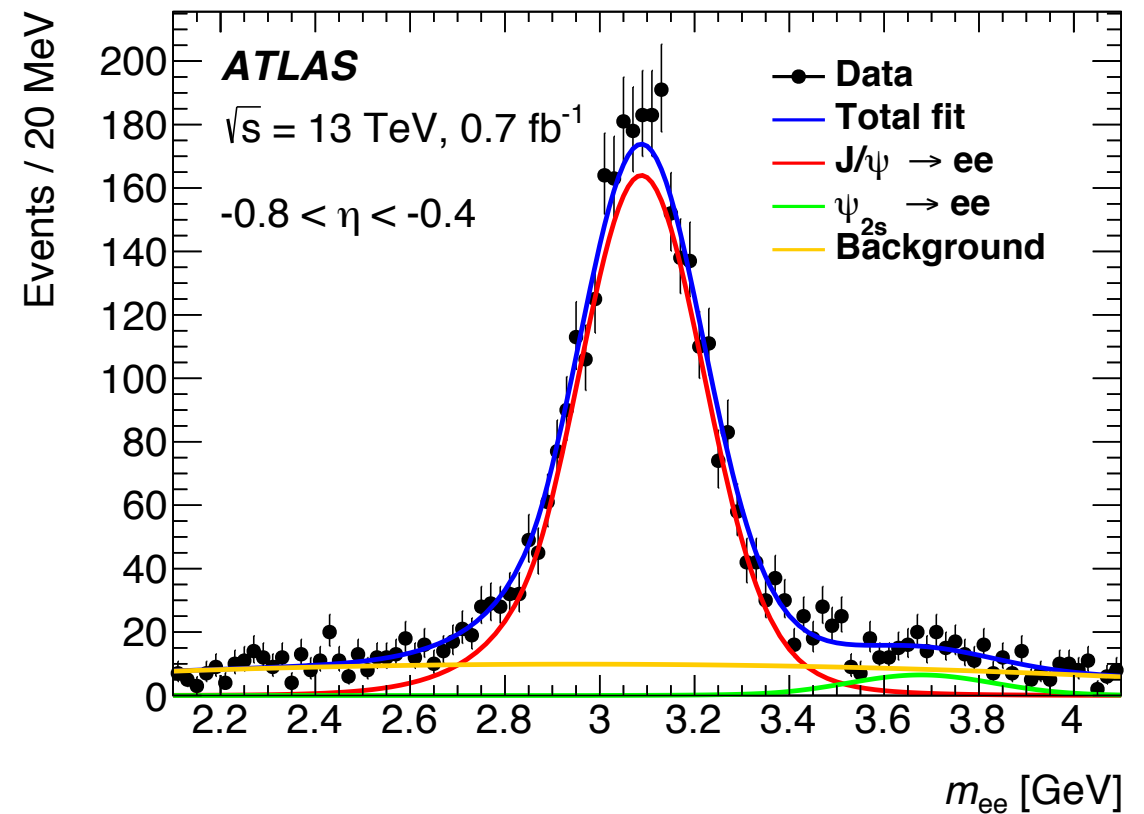

Summary of uncertainties on energy scale and resolution (photons)

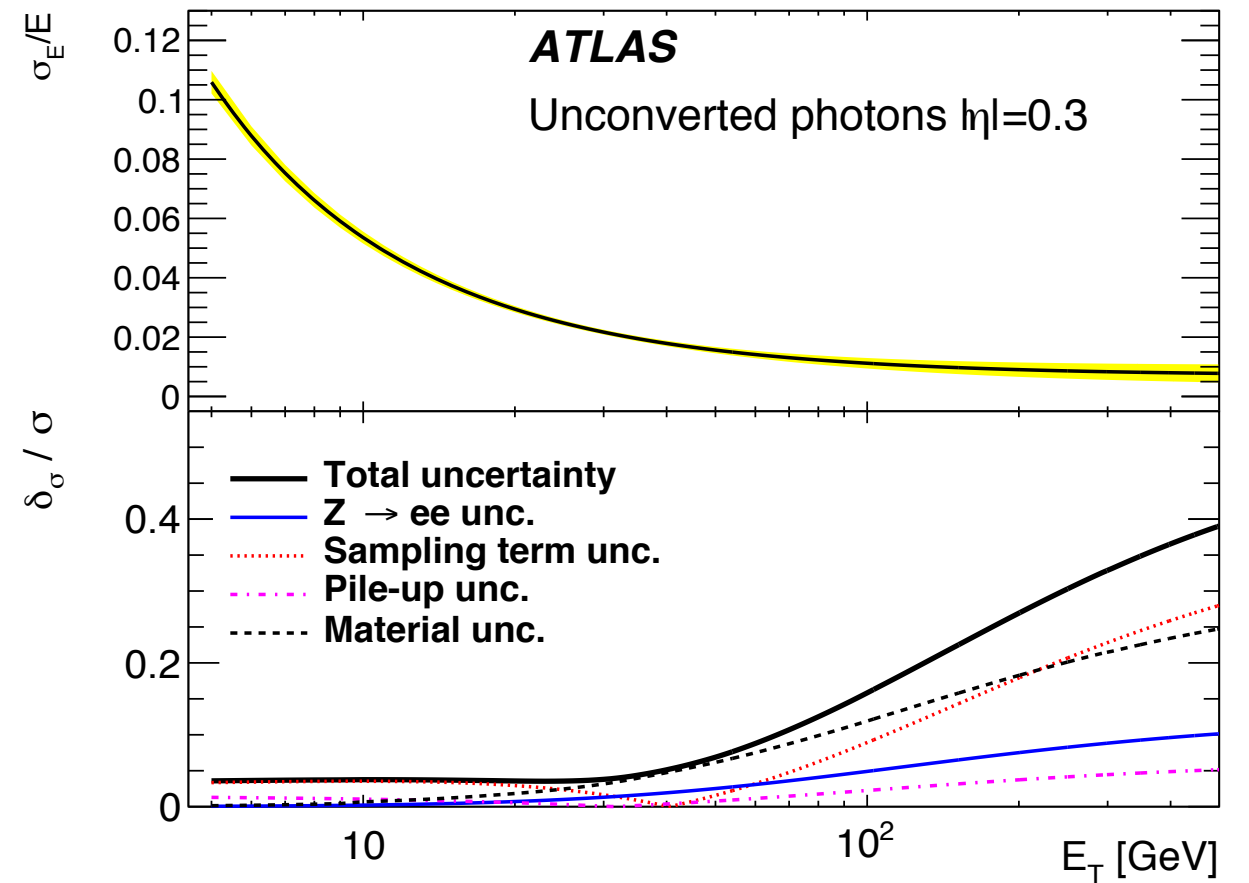
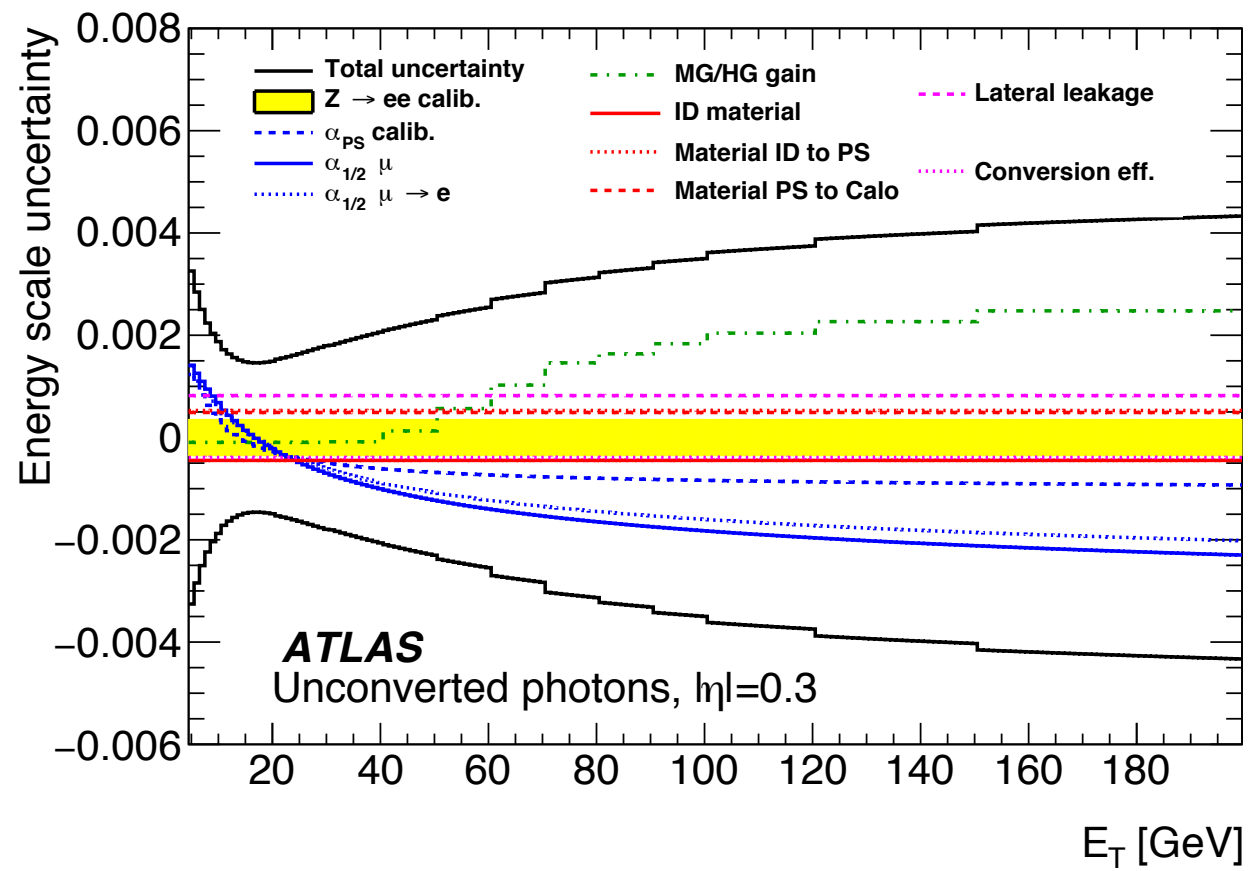

Outline

- Photon (and Electron) identification exploiting the calorimeter granularity
- Position and direction measurement with the calorimeter
- Photon and electron energy calibration and data-driven studies
- **Application to $H \rightarrow \gamma\gamma$ analysis from 2012 to now**
- Phase 1 and Phase 2 upgrades

$H \rightarrow \gamma\gamma$ analysis

- Start from photon identification + mass measurement
- Categorize events as function of production properties (=> "STX" cross-section) and S/B + mass resolution to enhance sensitivity
 - $H \rightarrow \gamma\gamma$ is ~the only decay mode with sensitivity to all Higgs boson production modes if enough statistics
- Alternatively, can also perform inclusive and differential cross-section with ~no model dependence since signal can be extracted with ~ uniform acceptance over a wide range of phase space.

Higgs Production and decay in the SM

<https://twiki.cern.ch/twiki/bin/view/LHCPhysics/CrossSections>

[LHC Higgs X-sec WG]

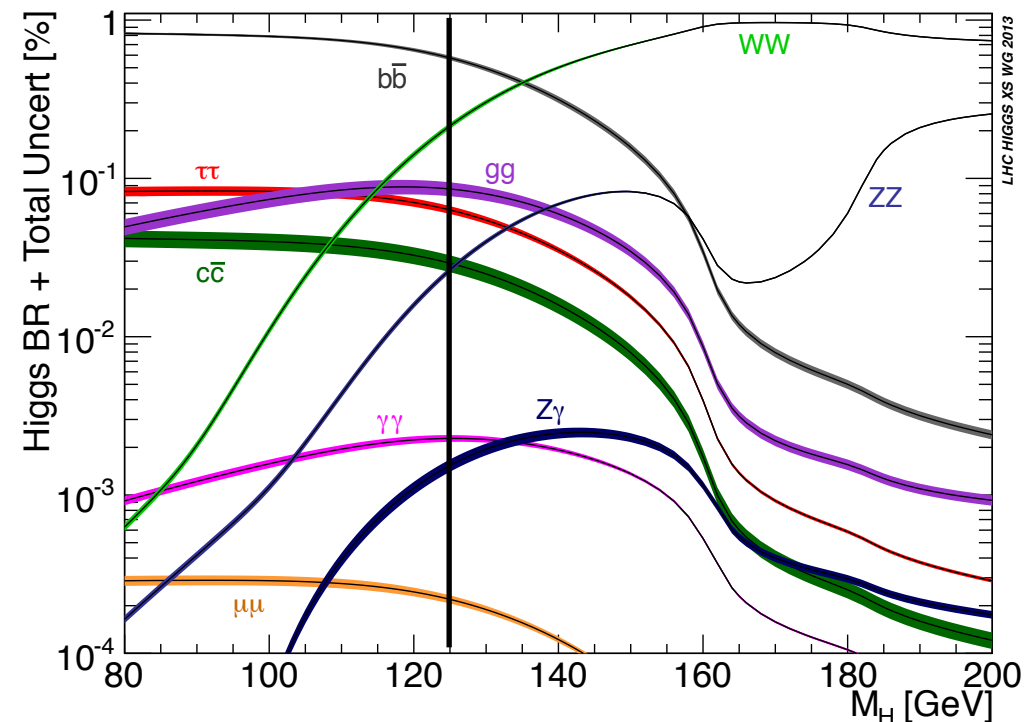
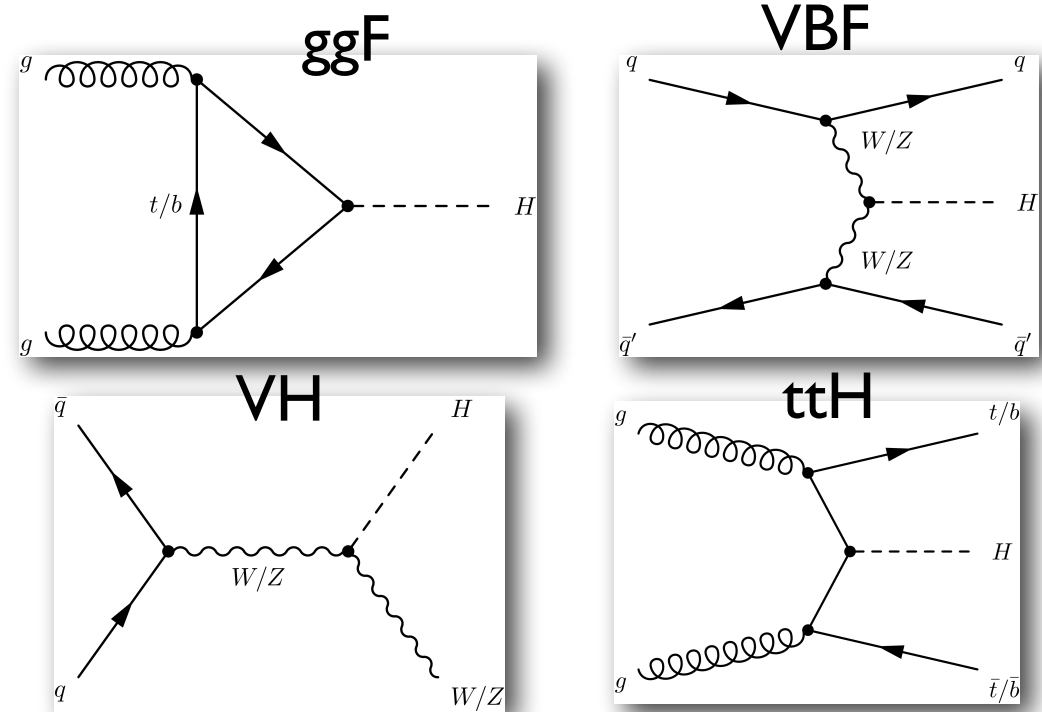
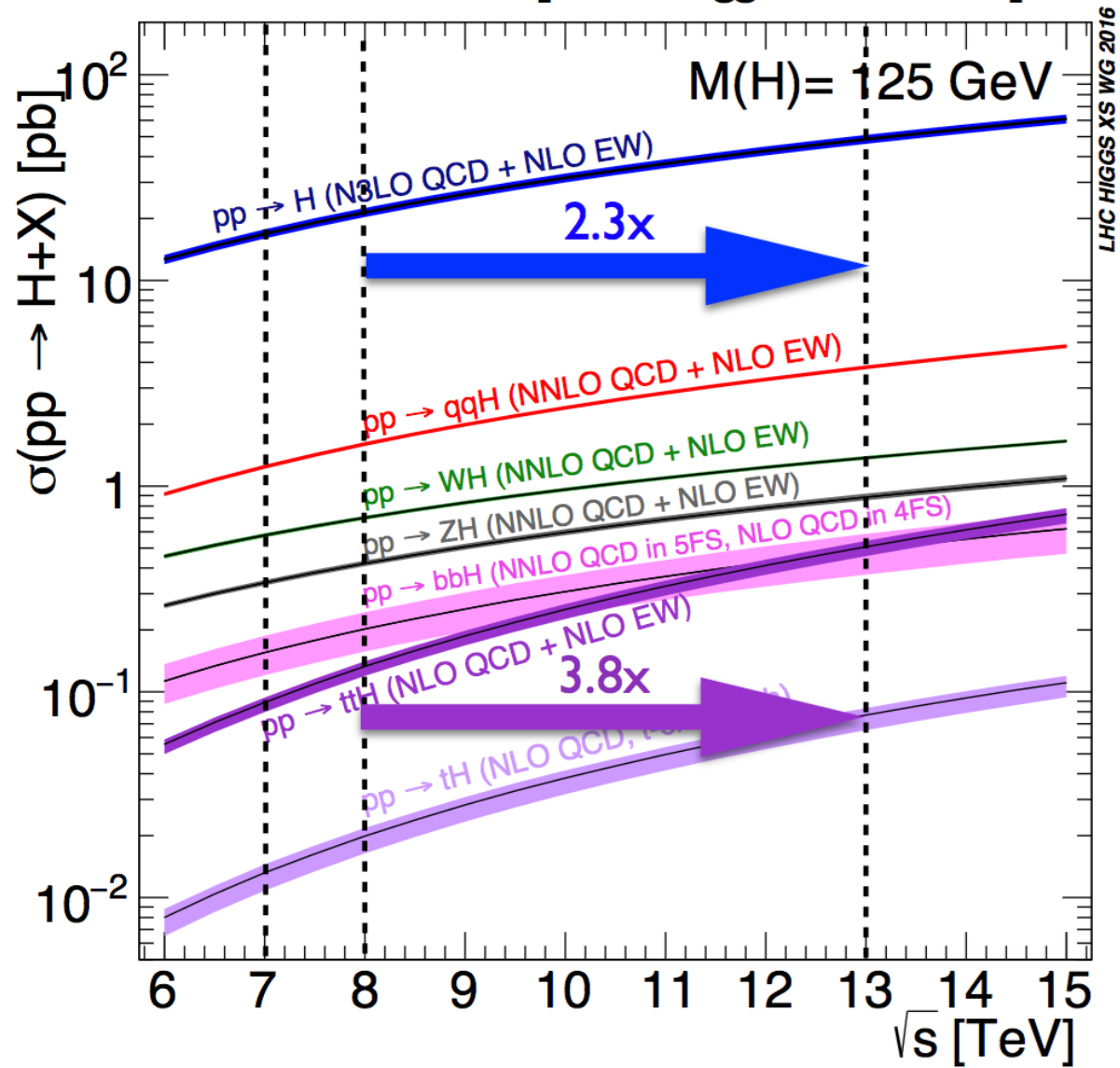

Gluon fusion cross-section computed at N³LO accuracy
 Uncertainty on theory prediction now at O(5%) level
 About 8 Million Higgs events produced per experiment since LHC start

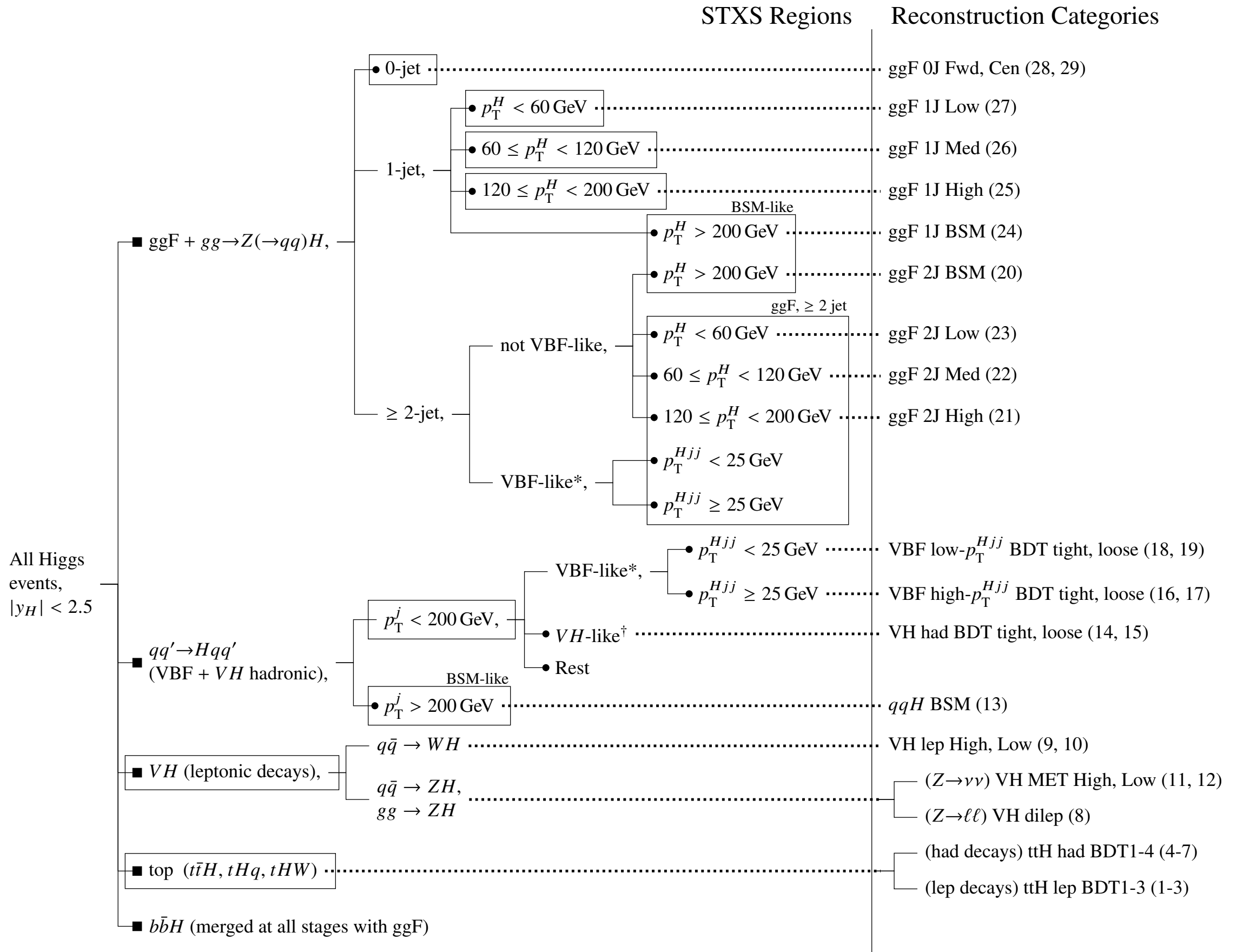

*VBF-like: $m_{jj} > 400$ GeV, $|\Delta y_{jj}| > 2.8$

[†]VH-like: $60 < m_{jj} < 120$ GeV

Typical expected mass resolutions in run 2 data

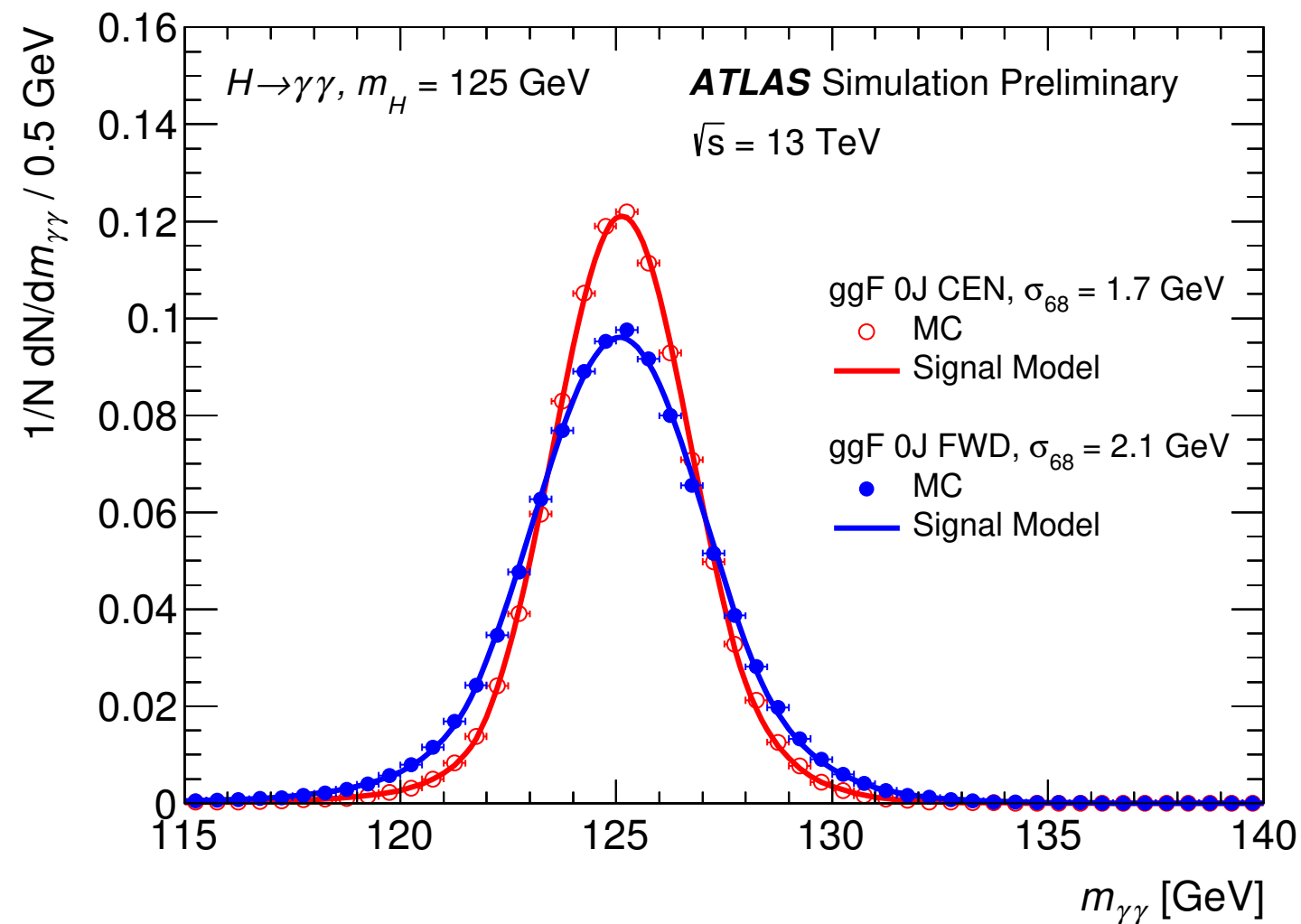

this is typically $\sim 10\text{-}15\%$ larger than run 1 because of the higher pileup
At $\mu \sim 60$, pileup noise becomes similar to sampling term for 60 GeV E_t
unconverted photons in the barrel

Background derived directly from data sideband fit

2012 discovery plot

80 fb⁻¹ run 2 (2015-2017 data)

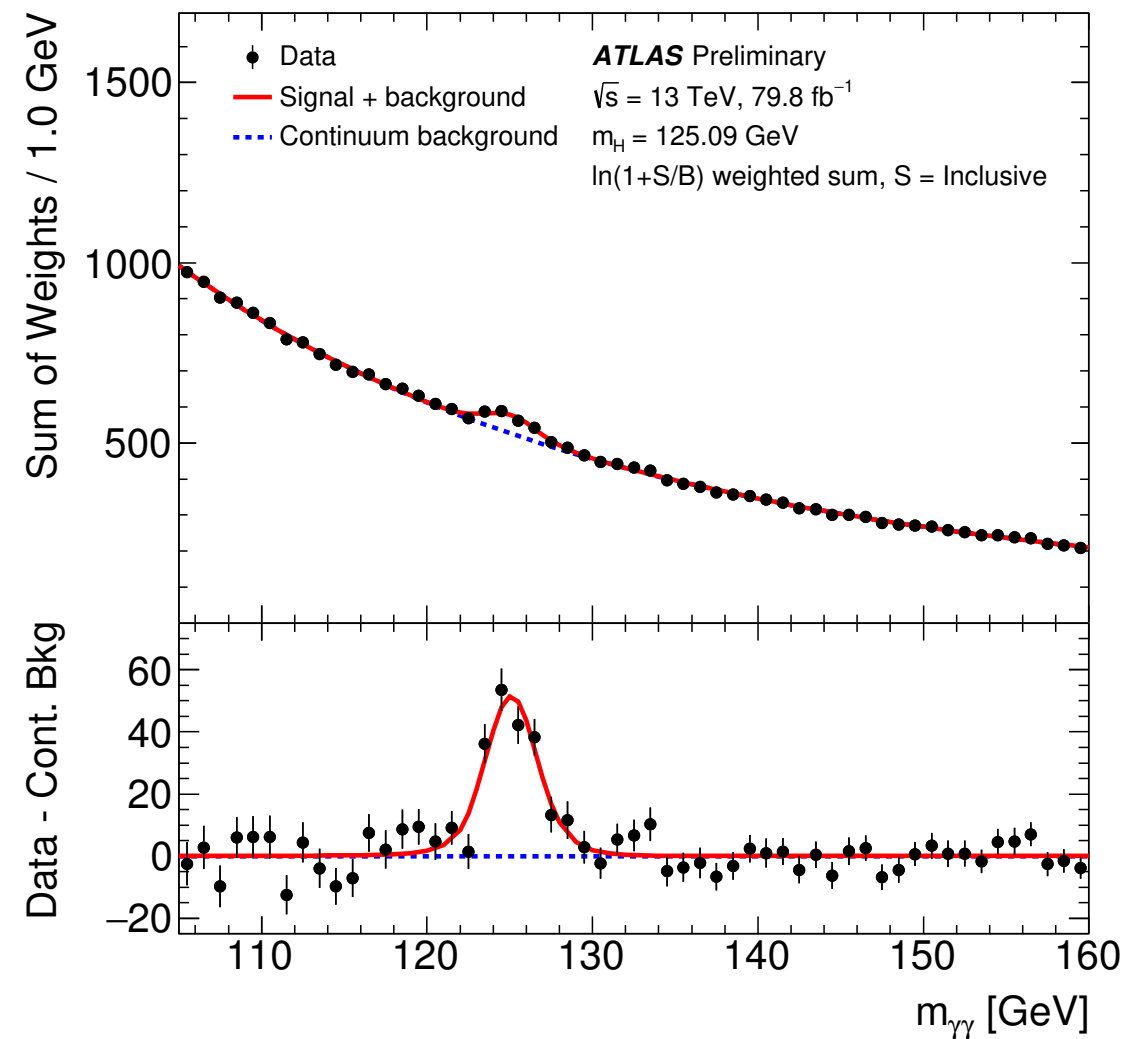
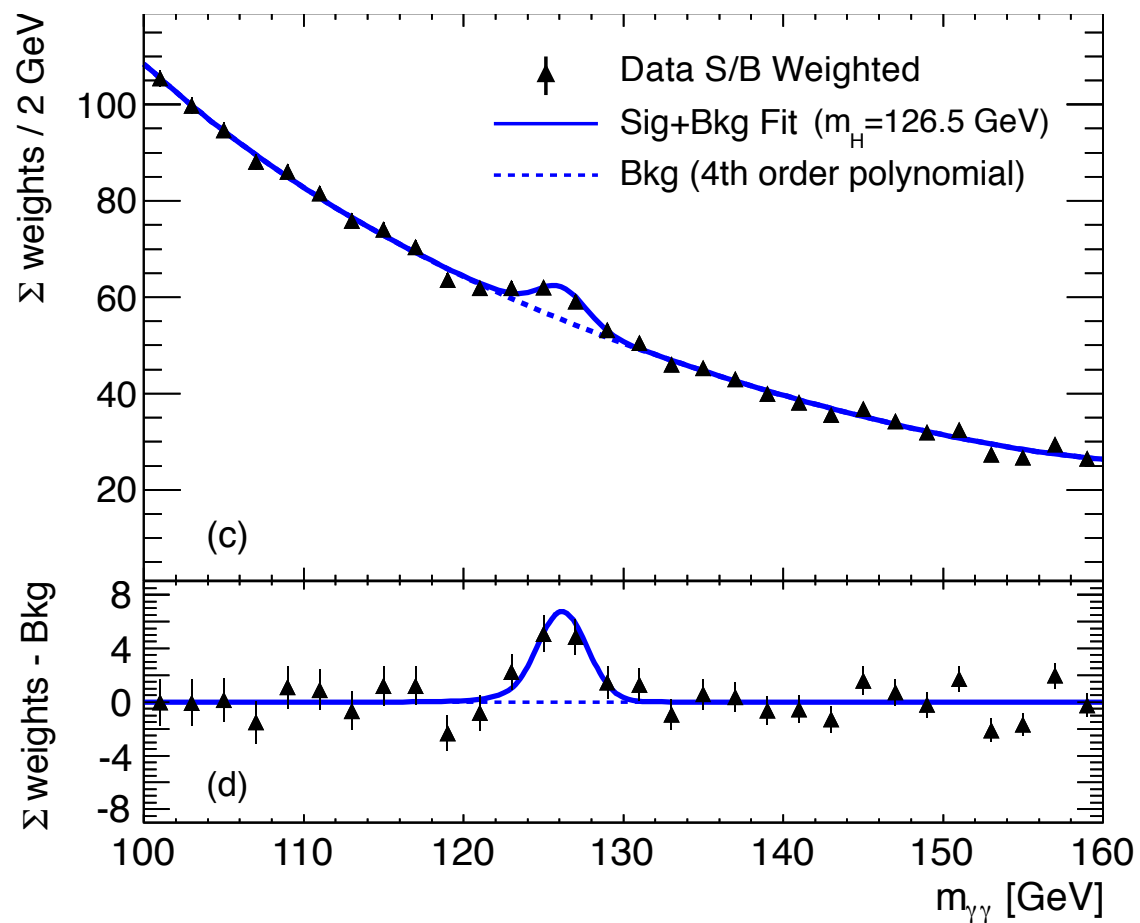

STX cross-section measurements

(2015-2017 data)

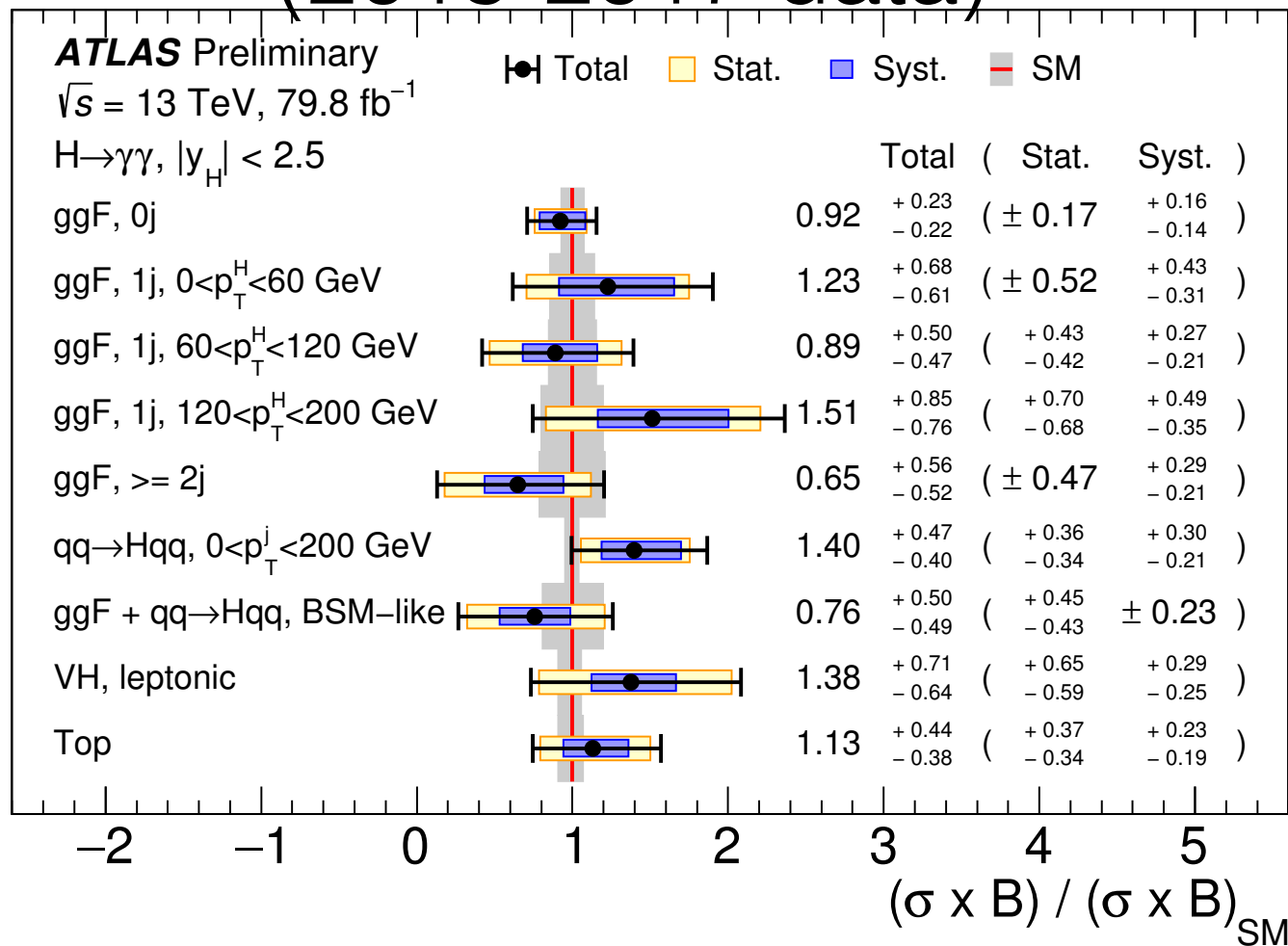

Uncertainties on inclusive cross-section*BR

Source	Uncertainty (%)
Fit (stat.)	10
Fit (syst.)	8.3
Photon energy scale & resolution	4.0
Background modeling (spurious signal)	7.3
Correction factor	5.2
Photon isolation efficiency	4.6
Pileup	1.9
Photon ID efficiency	1.3
Trigger efficiency	0.7
Dalitz Decays	0.4
Theoretical modeling	$+0.3$ -0.4
Diphoton vertex selection	0.1
Photon energy scale & resolution	0.1
Luminosity	2.0
Total	14

Differential cross-section measurement

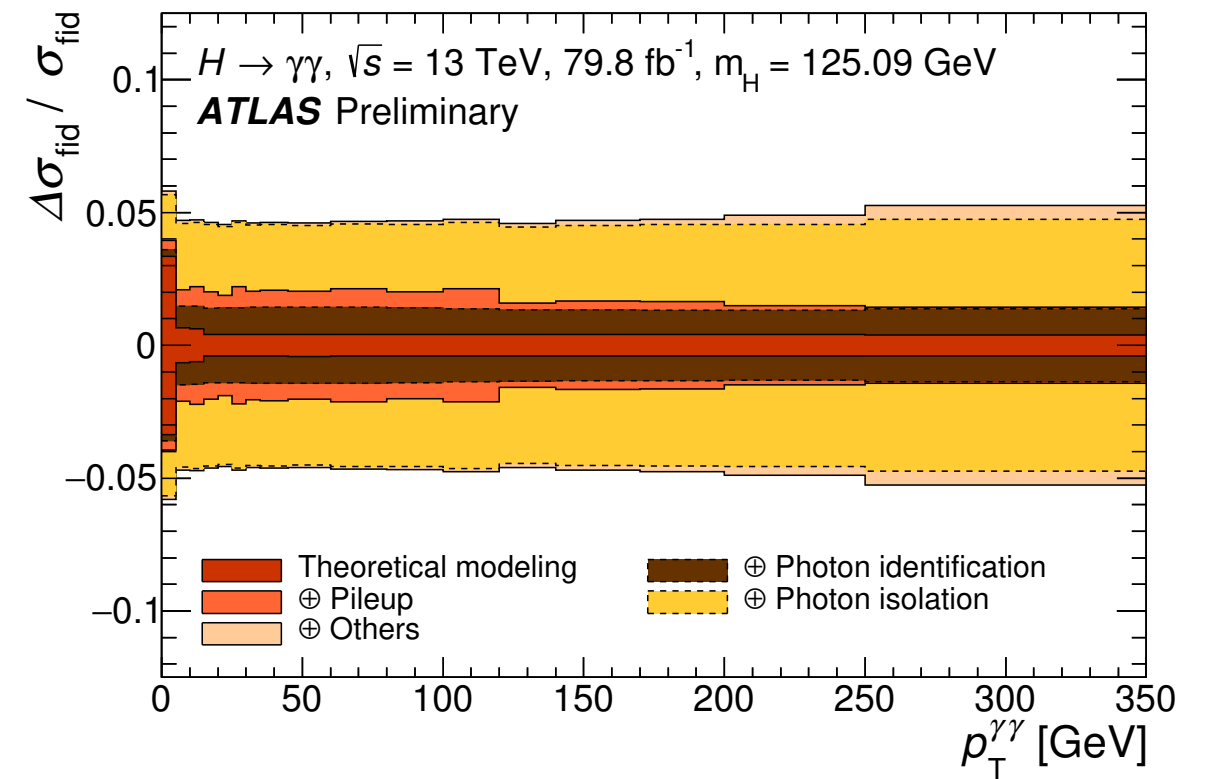
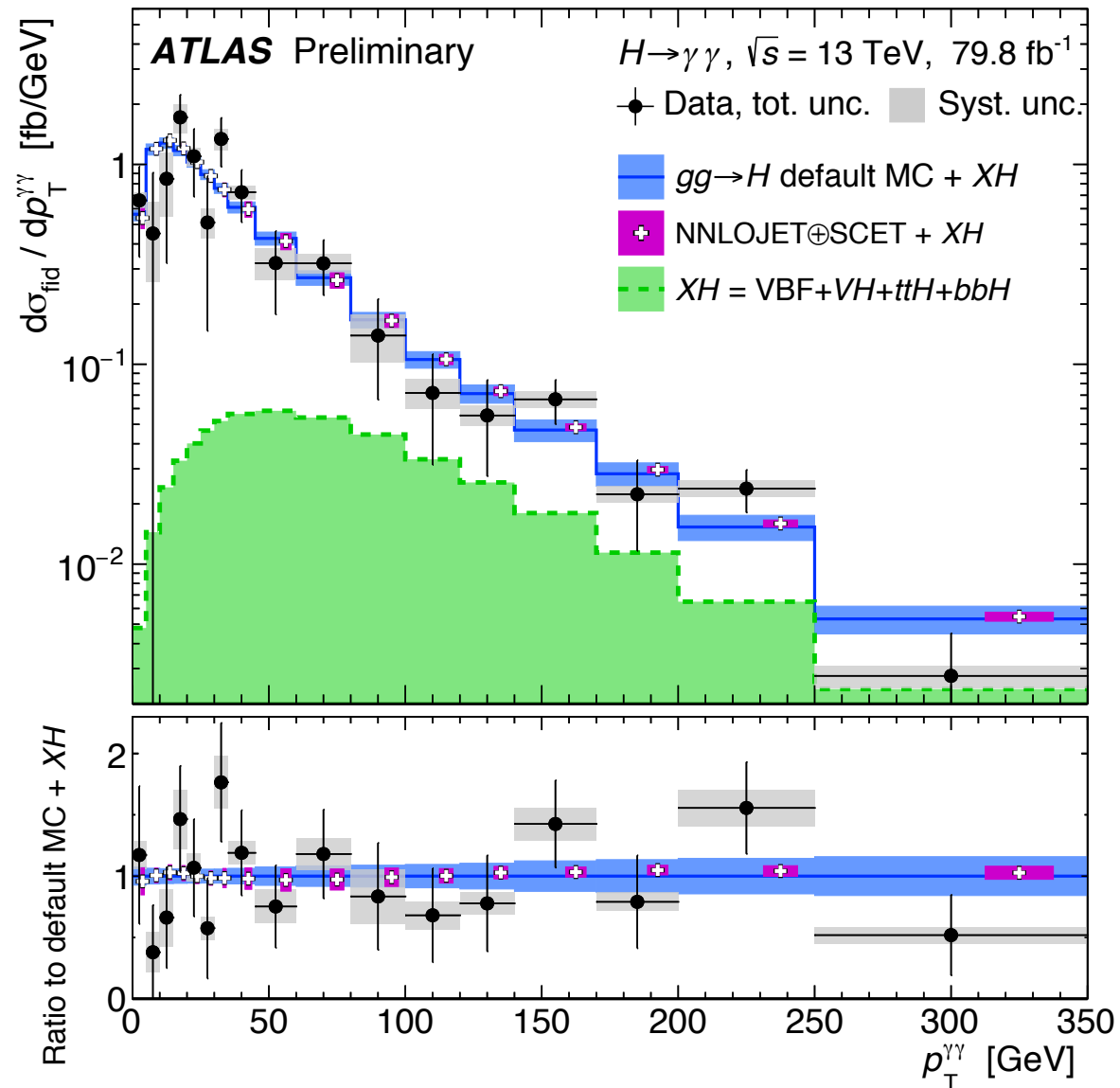

=> measurement still limited by stat. uncertainties

Looking at the "rare" production mode with $H \rightarrow \gamma\gamma$ (BR $\sim 0.2\%$)

(neural network optimized to separate S and B in events
with/without leptons from top decays)

(2015-2018 data)

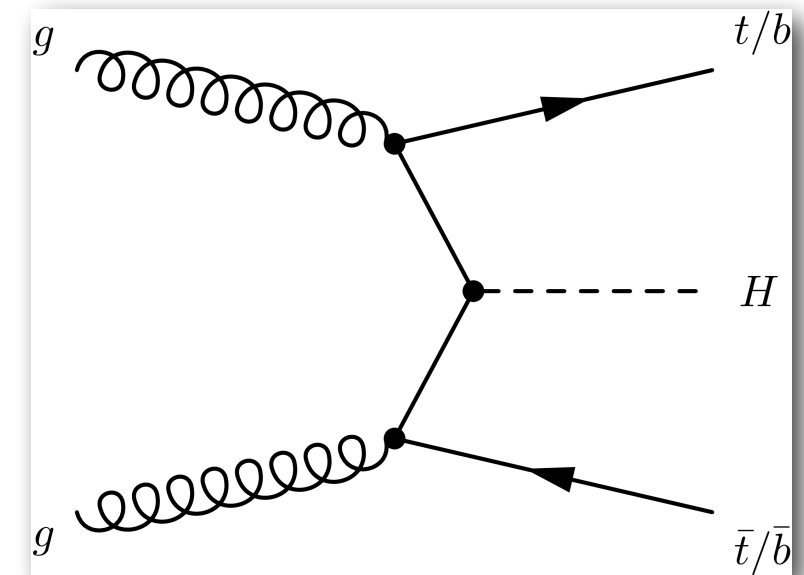
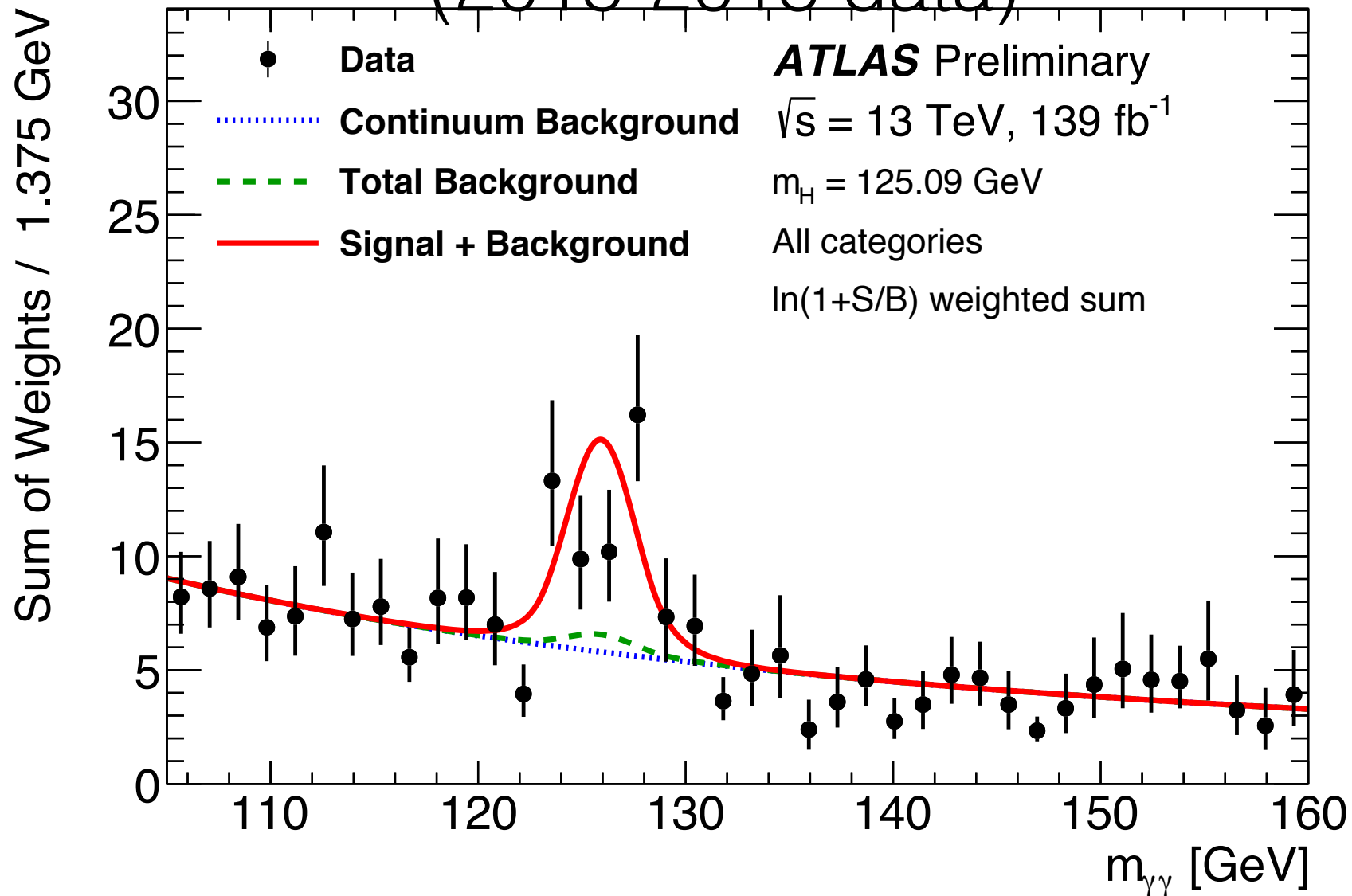

4.9 sigma significance

$\sigma \cdot \text{BR} = 1.59^{+0.43}_{-0.39} \text{ fb}$

SM $1.15^{+0.09}_{-0.12} \text{ fb}$

How does it compare to other decay modes ?

Example interpretation in κ_V , κ_F coupling modifiers for H couplings to bosons and fermions and fermions

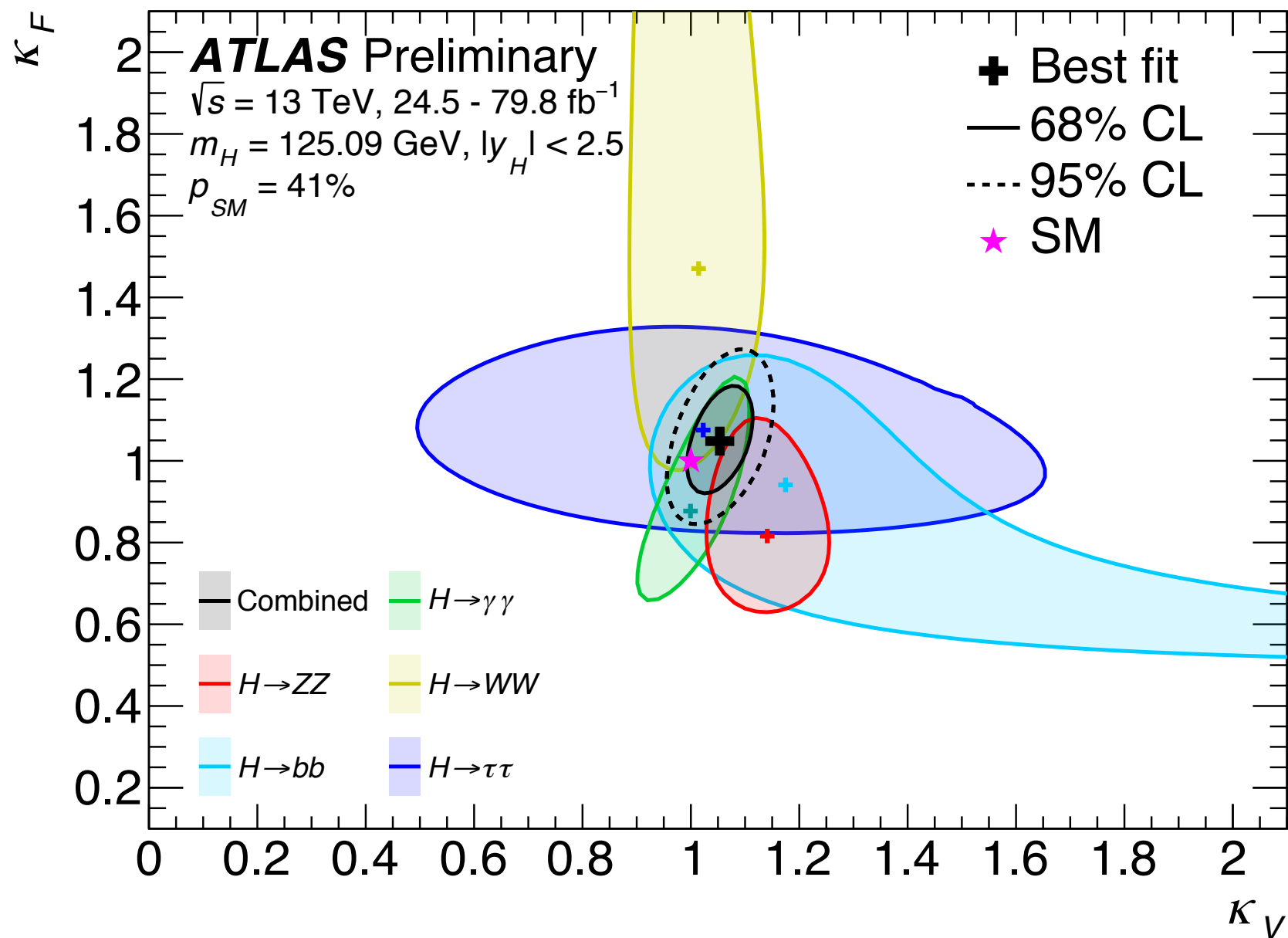

Run-2 Higgs boson mass measurements

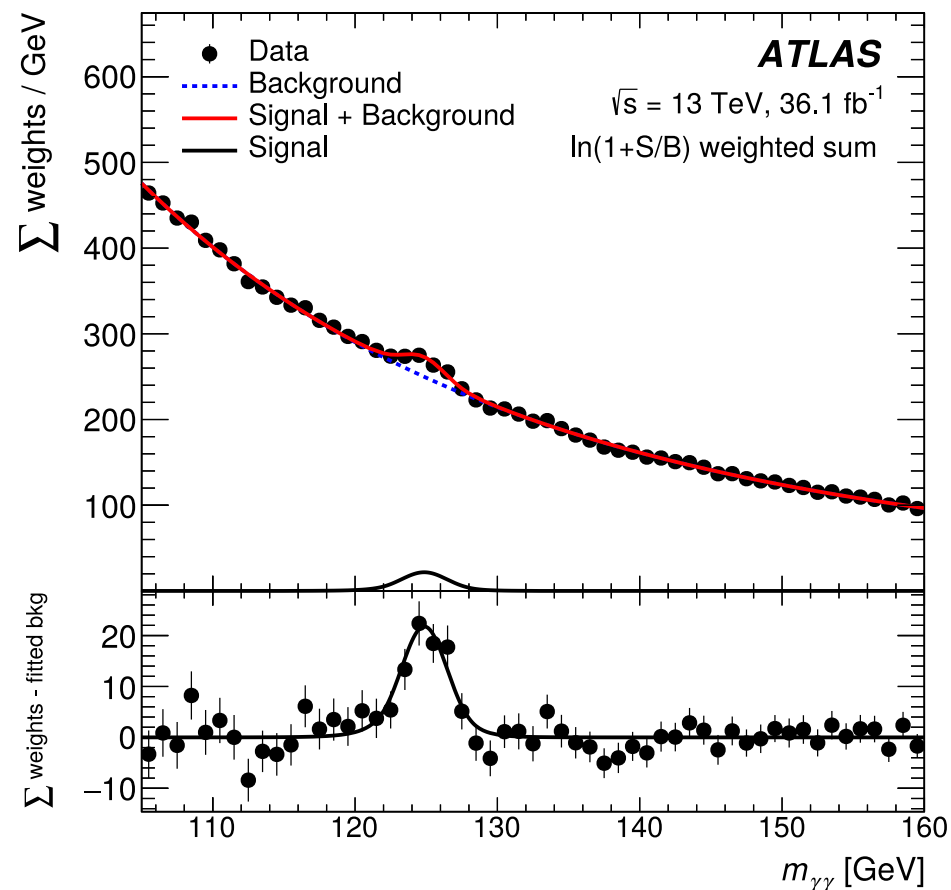

ATLAS $\gamma\gamma$ channel
 same categories as
 for coupling
 $124.93 \pm 0.40 \text{ GeV}$
 $(\pm 0.21_{\text{stat}} \pm 0.34_{\text{syst}})$

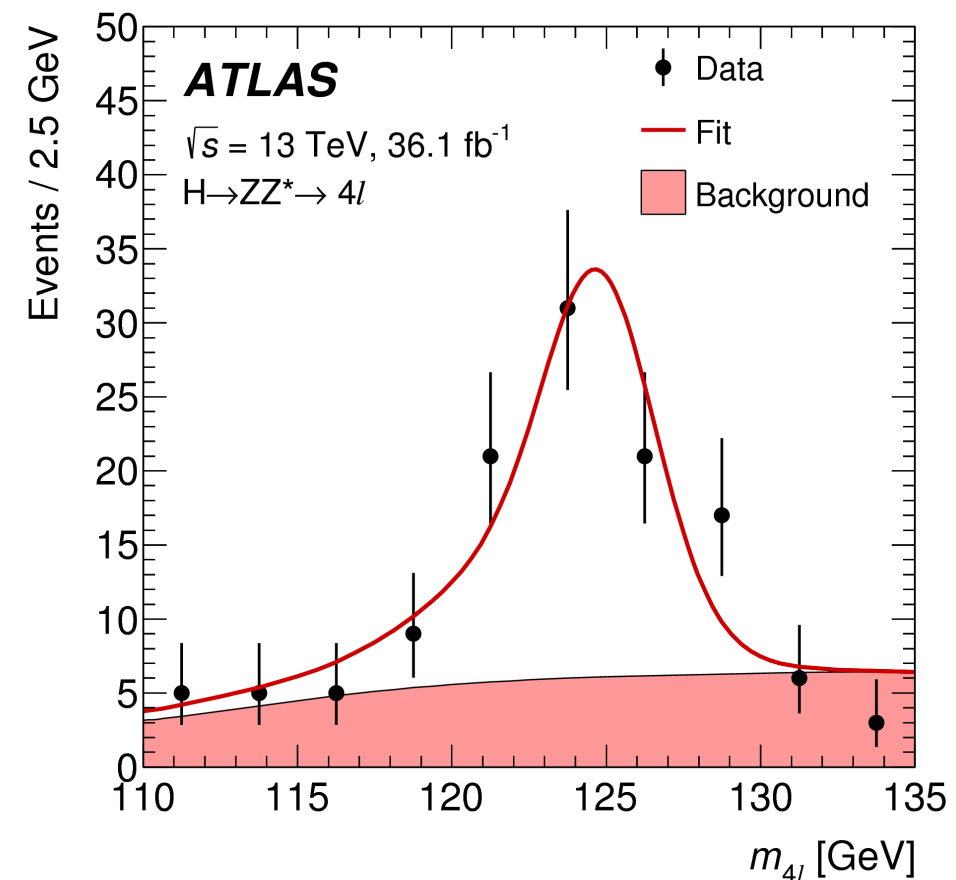

ATLAS $4l$ channel
 event-by event resolution
 +S/B discriminant
 $124.79 \pm 0.37 \text{ GeV}$

combined ATLAS run1+run2

$124.97 \pm 0.24 \text{ GeV} (\pm 0.19_{\text{stat}} \pm 0.13_{\text{syst}})$

Syst. uncertainties mainly from photon energy scale

Systematic uncertainties on $H \rightarrow \gamma\gamma$ mass measurement (run 2)

Source	Systematic uncertainty on $m_H^{\gamma\gamma}$ [MeV]
EM calorimeter cell non-linearity	± 180
EM calorimeter layer calibration	± 170
Non-ID material	± 120
ID material	± 110
Lateral shower shape	± 110
$Z \rightarrow ee$ calibration	± 80
Conversion reconstruction	± 50
Background model	± 50
Selection of the diphoton production vertex	± 40
Resolution	± 20
Signal model	± 20

(run 1)	ATLAS $H \rightarrow \gamma\gamma$	CMS $H \rightarrow \gamma\gamma$
Scale uncertainties:		
ATLAS ECAL non-linearity / CMS photon non-linearity	0.14 (0.16)	0.10 (0.13)
Material in front of ECAL	0.15 (0.13)	0.07 (0.07)
ECAL longitudinal response	0.12 (0.13)	0.02 (0.01)
ECAL lateral shower shape	0.09 (0.08)	0.06 (0.06)
Photon energy resolution	0.03 (0.01)	0.01 (<0.01)
ATLAS $H \rightarrow \gamma\gamma$ vertex & conversion reconstruction	0.05 (0.05)	—
$Z \rightarrow ee$ calibration	0.05 (0.04)	0.05 (0.05)
CMS electron energy scale & resolution	—	—
Muon momentum scale & resolution	—	—

Outline

- Photon (and Electron) identification exploiting the calorimeter granularity
- Position and direction measurement with the calorimeter
- Photon and electron energy calibration and data-driven studies
- Application to $H \rightarrow \gamma\gamma$ analysis from 2012 to now
- **Phase 1 and Phase 2 upgrades**

Phase 1 upgrade of LAr trigger output

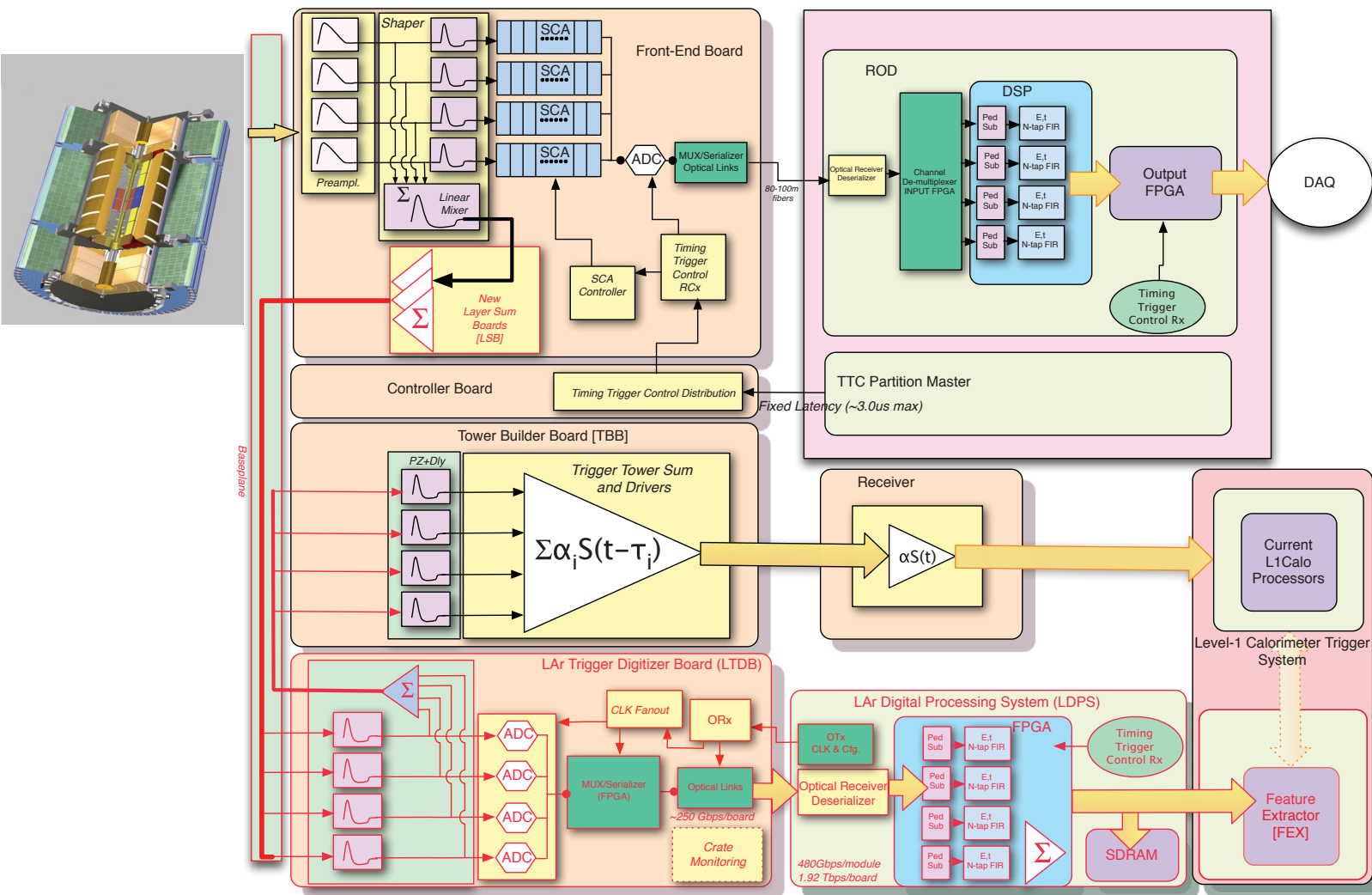

factor 10 increased granularity at level 1

super cells

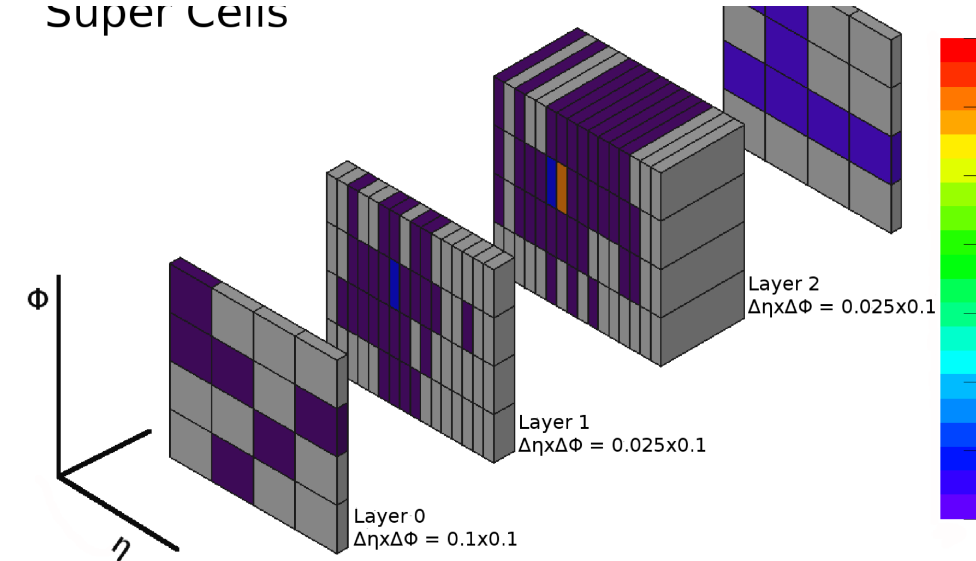

Installation started during LS2

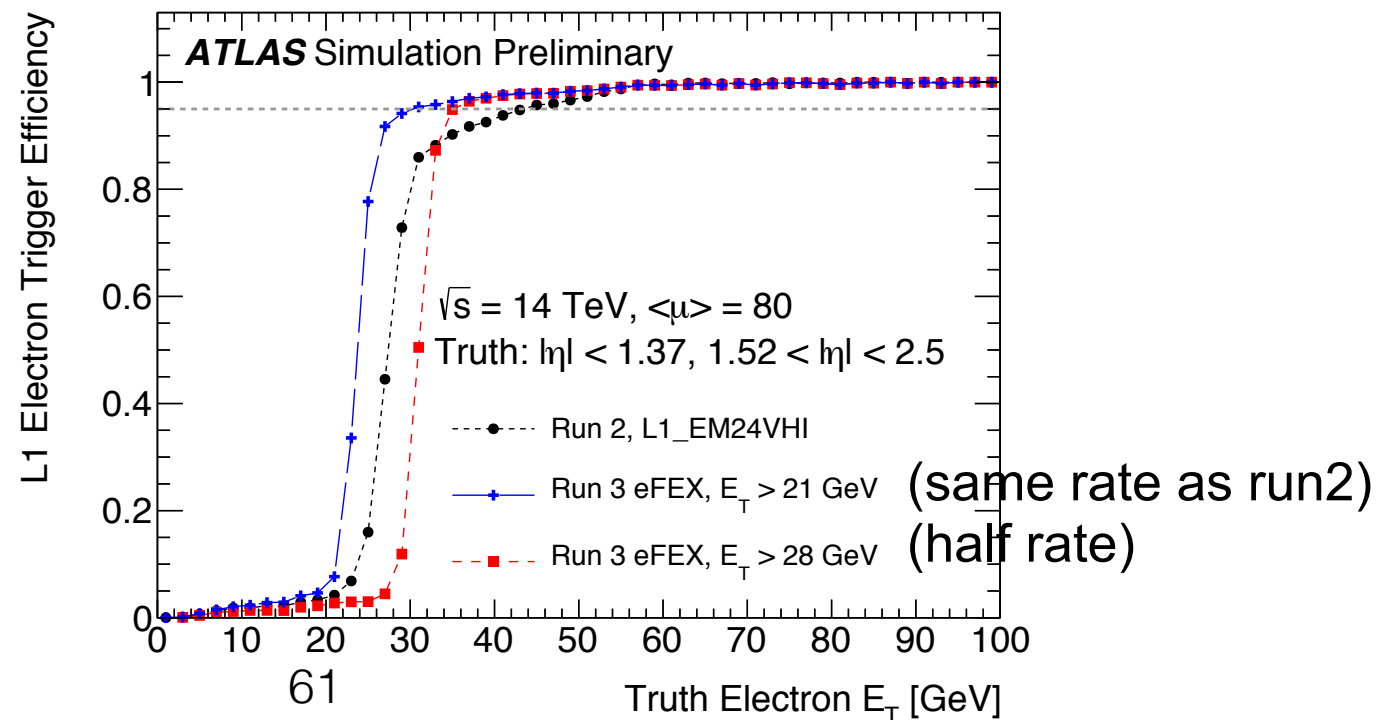

Phase 2 upgrade of LAr readout

Digitize all cells @ 40 MHz

"Similar" as phase 1 but 10x more cells and need full accuracy over complete dynamic range

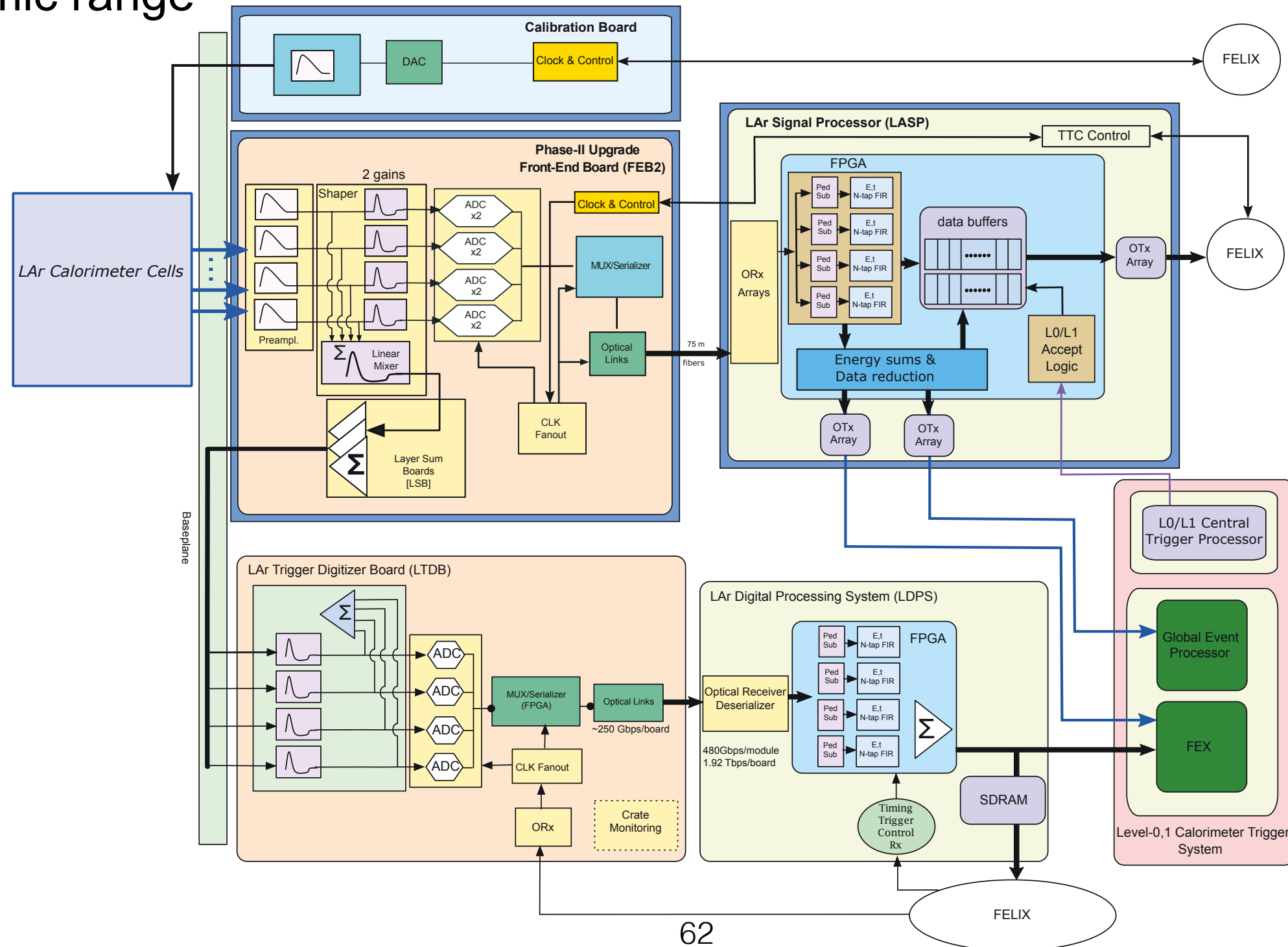

Photon energy resolution
with HL-LHC pileup level
assuming ~same technique as today

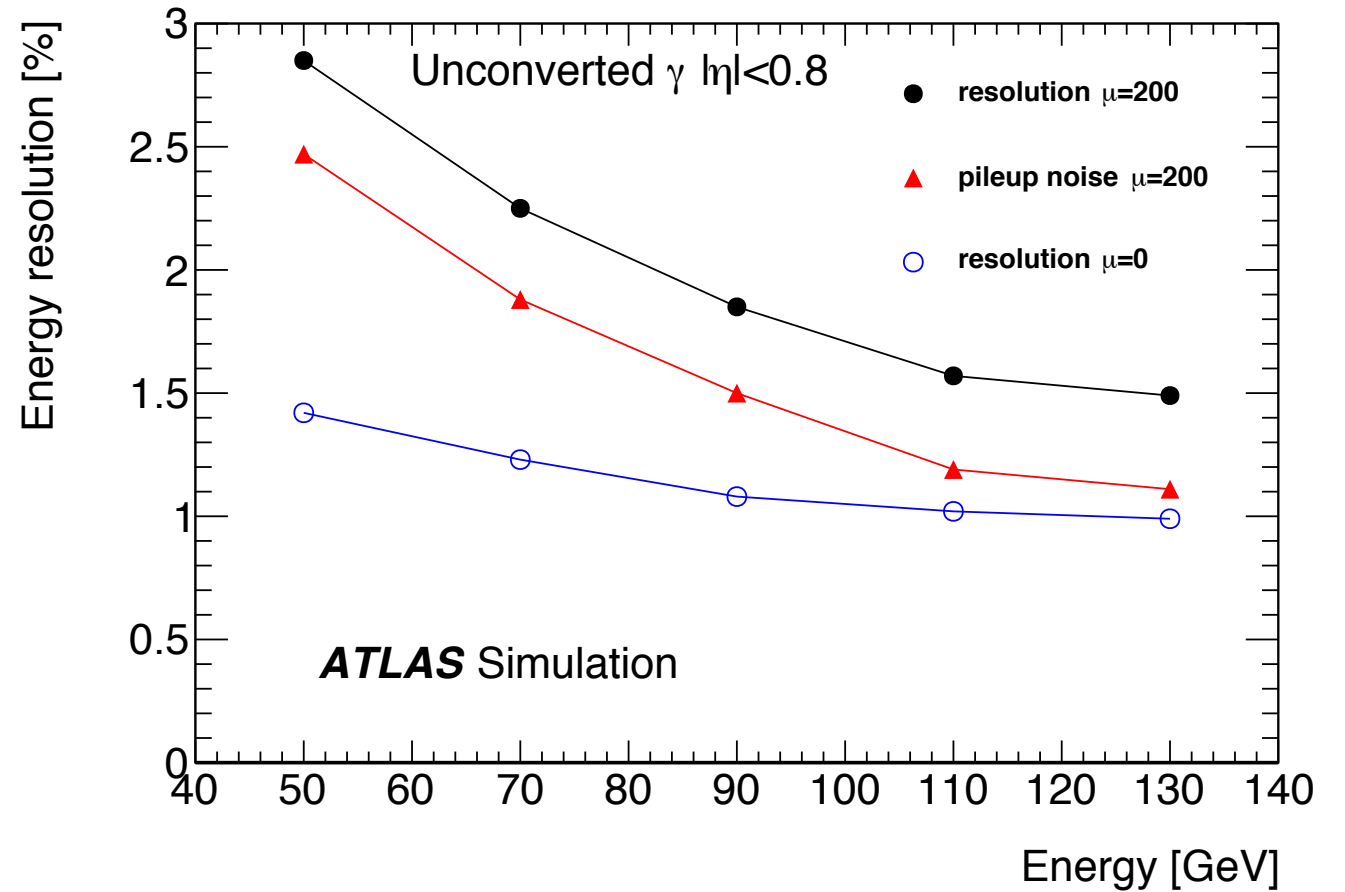

Mass resolution

Pessimistic = extrapolation from today

Optimistic = assume out of time pileup contribution can be ~suppressed with to information provided by new readout + more optimized filters (i.e it is like having a pileup of 75) + some (moderate) improvements in constant term

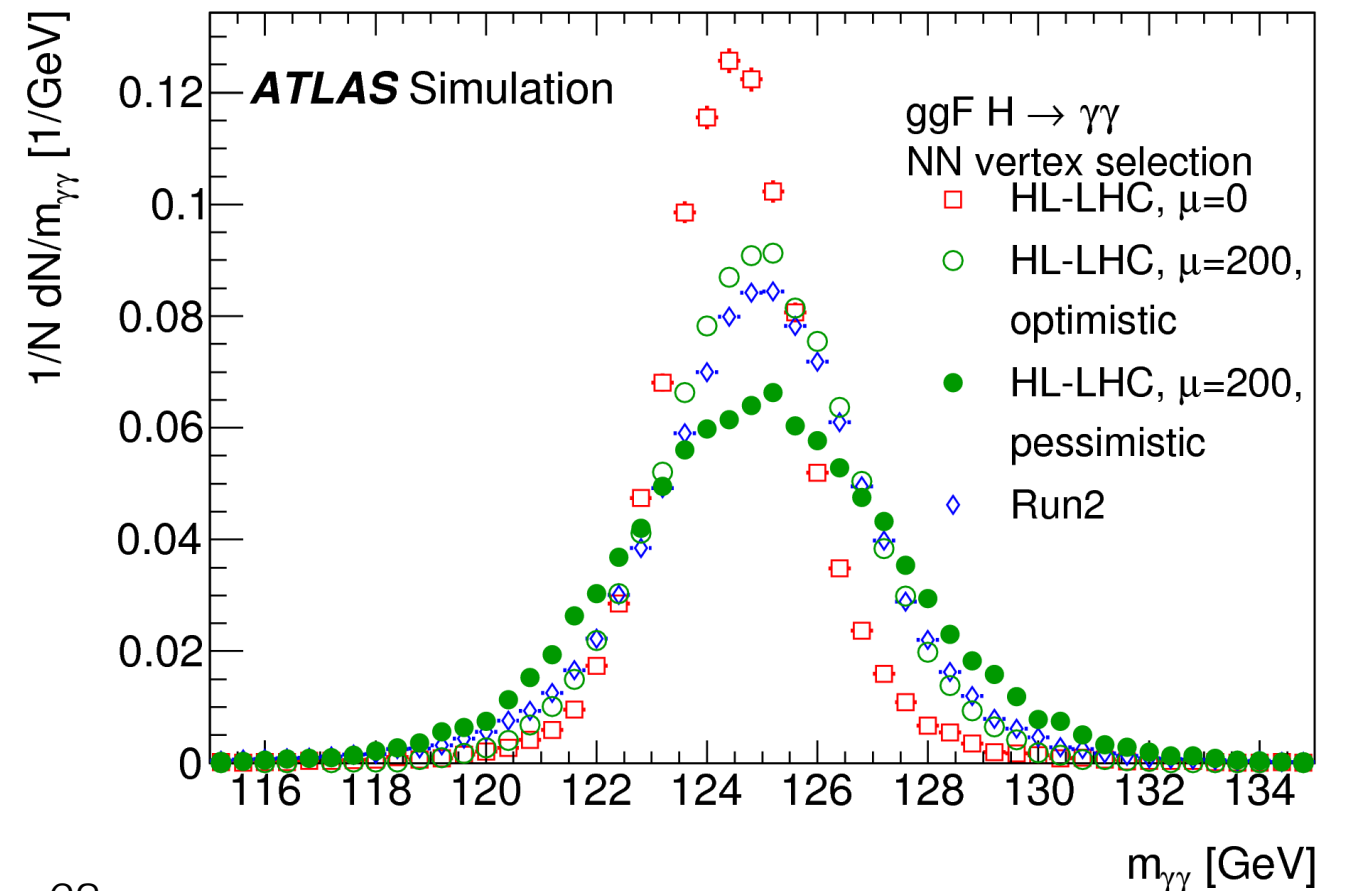

Prospects for Higgs coupling studies and HH production

$H \rightarrow \gamma\gamma$ gives precise measurement for 5 main H production processes

For HH, $b\bar{b} \gamma\gamma$ is one of the most sensitive channel

(assume ~ same performance as in run 2)

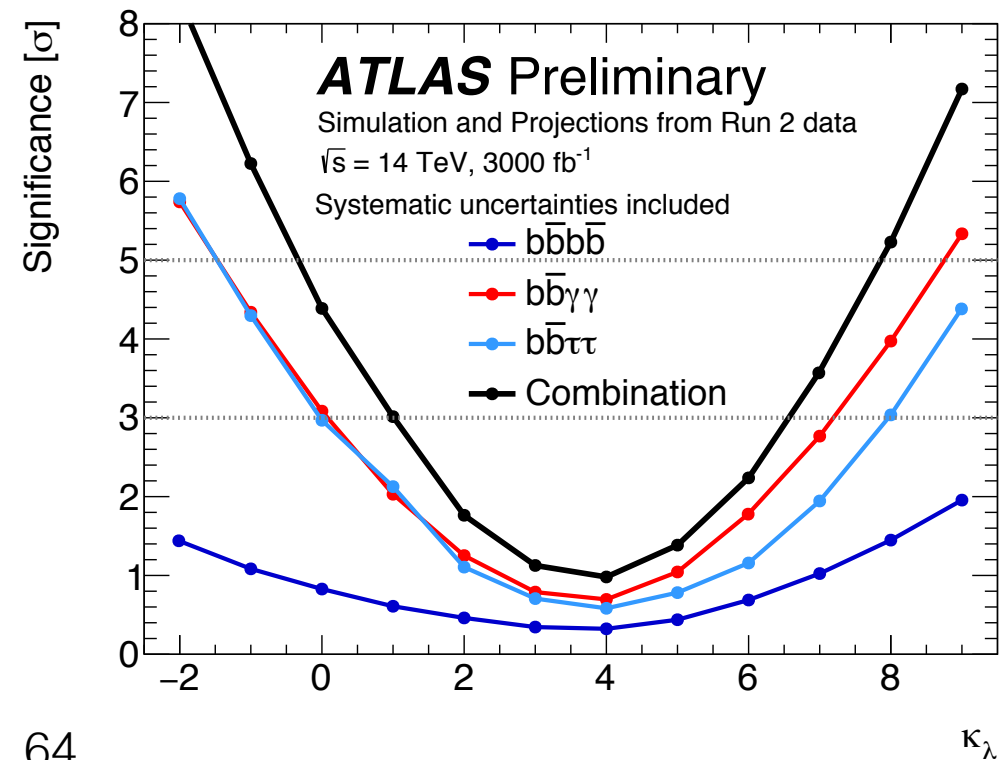
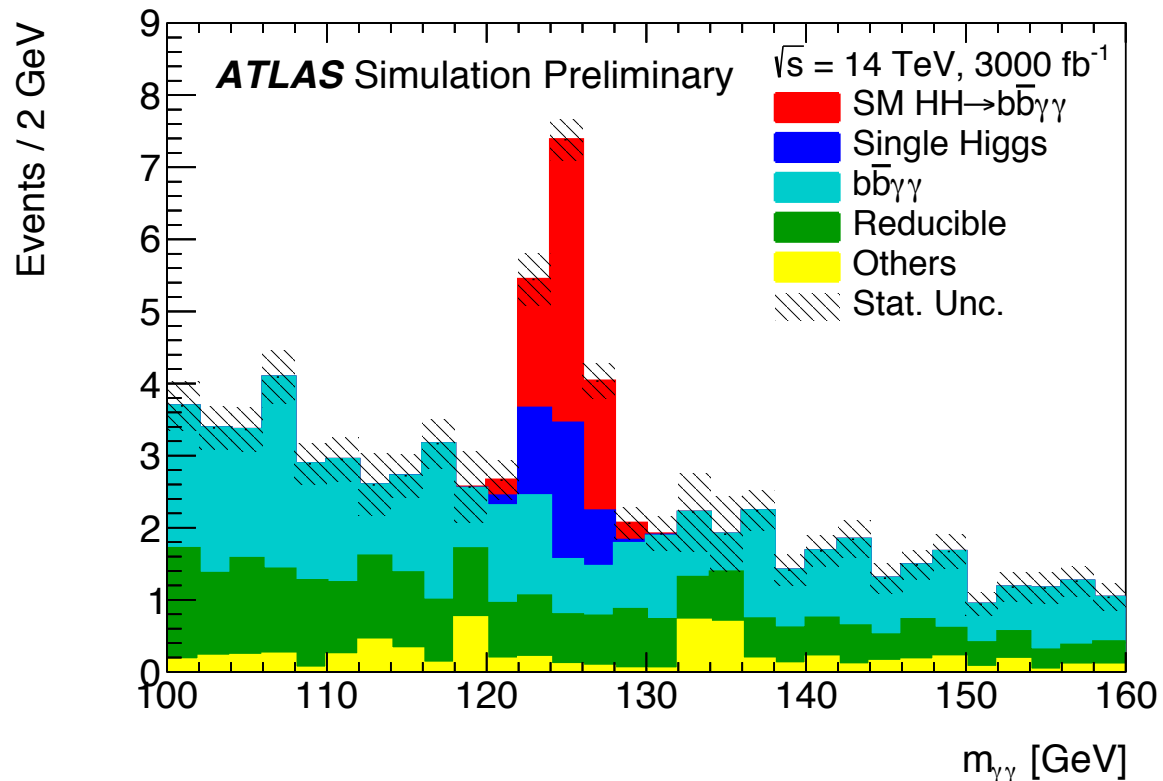
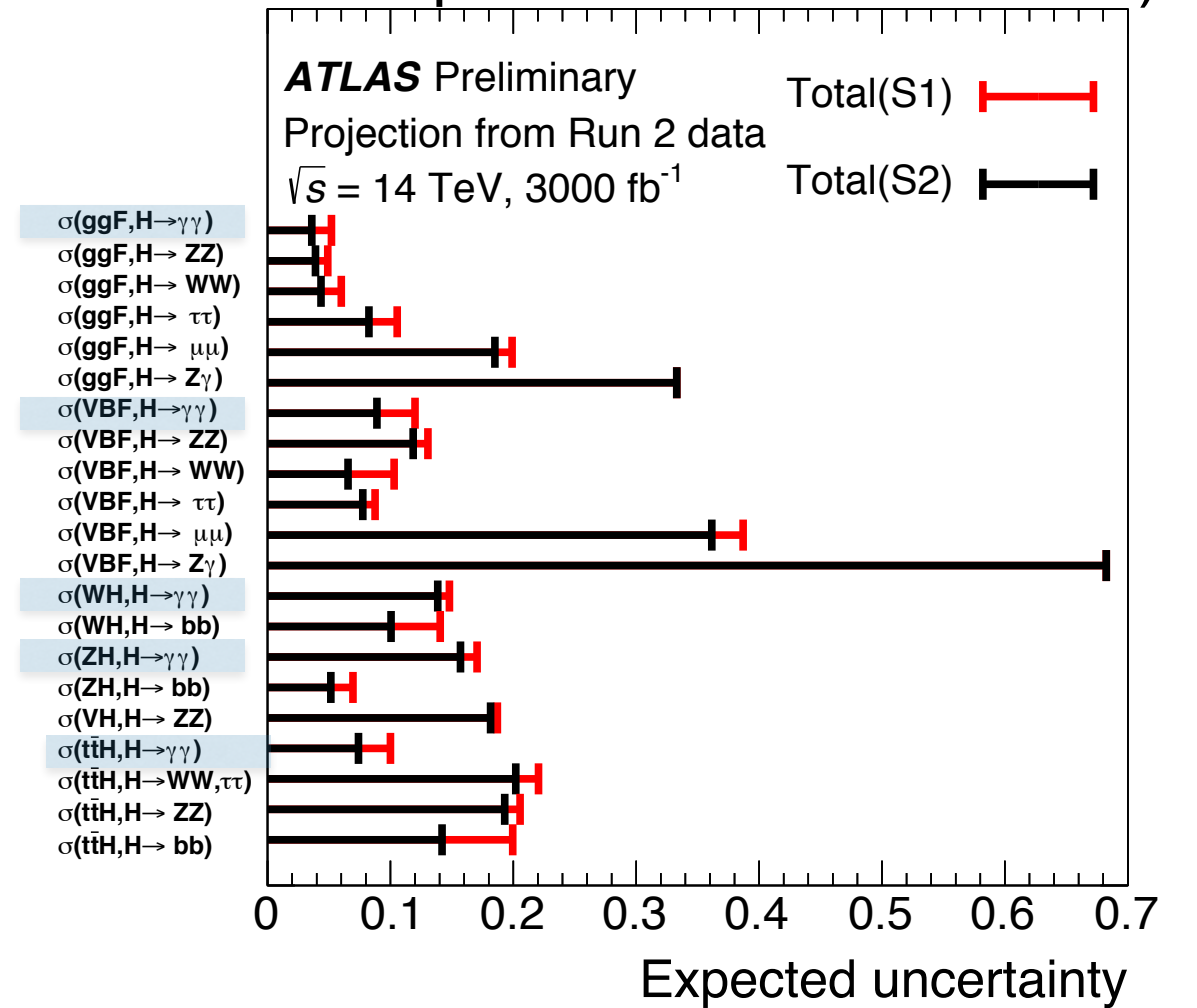

All channels combined

K_V, K_F fit

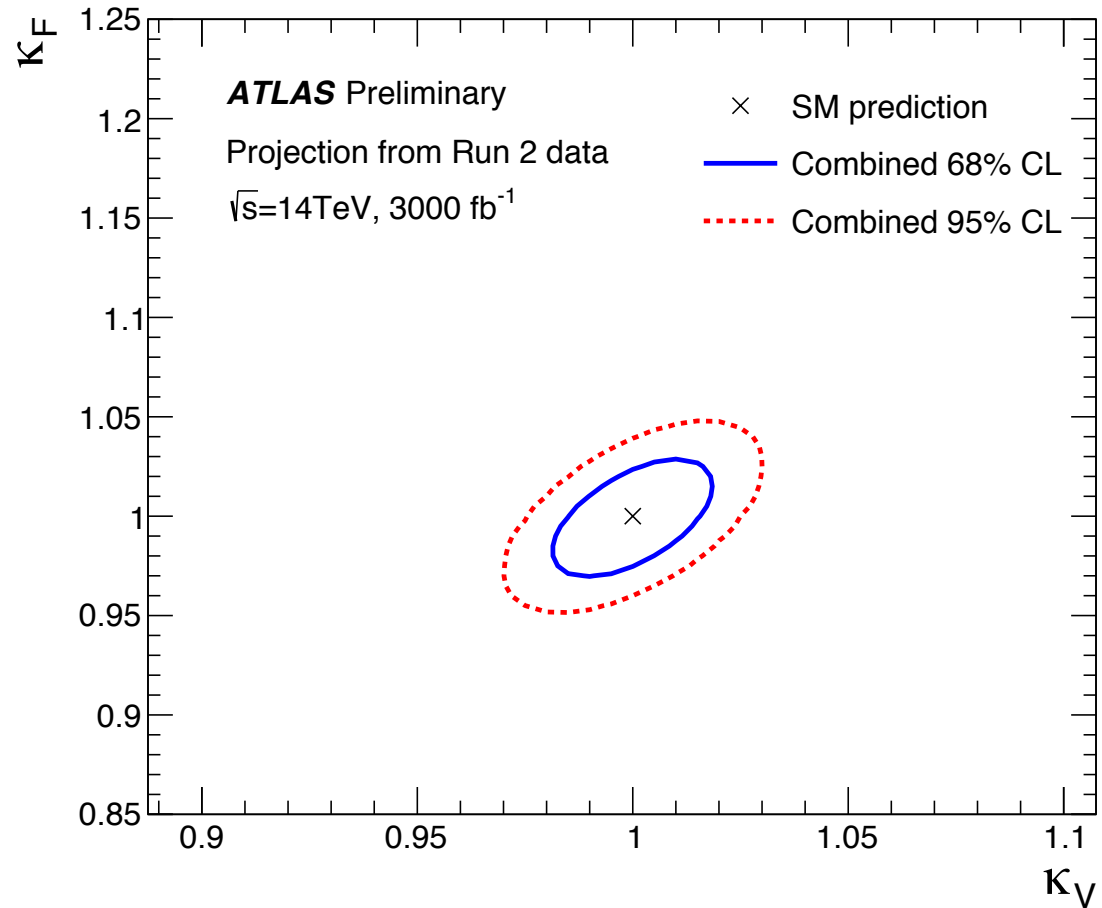

Separate coupling modifiers +BSM decay (assume $k_V < 1$)

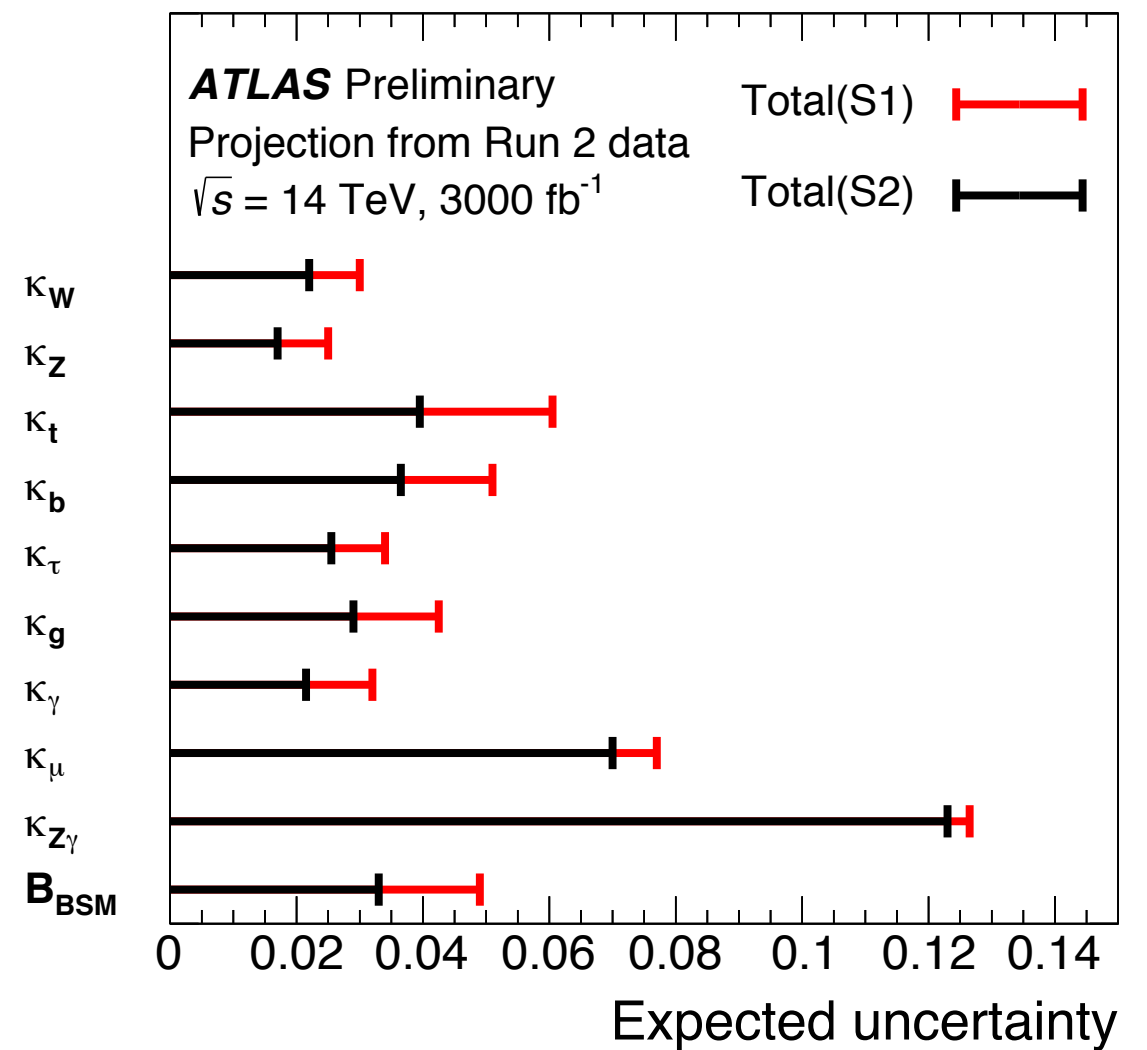

Conclusions

- Performance of LAr EM ATLAS Calorimeter consistent with expectations and allowed good sensitivity for $H \rightarrow \gamma\gamma$
- Although some aspects turned out to be a bit more involved than expected and required precise data-driven calibration corrections
- Good stability of the response with time and luminosity (although small effects start to be visible)
- The calorimeter performance will still allow good sensitivity to $H \rightarrow \gamma\gamma$ decays in the context of the HL-LHC program
 - But better mitigation of pileup effect on the energy resolution would be beneficial.